

Potomac Reservoir and River Simulation Model
User's Guide and Documentation

Gregory J. Prelewicz, P.E.
Erik R. Hagen, P.E.
Ani Kame'enui

The Section for Cooperative Water Supply Operations on the Potomac

Interstate Commission on the Potomac River Basin
6110 Executive Boulevard, Suite 300
Rockville, Maryland 20852

Report No. 04-03

The Interstate Commission on the Potomac River Basin

This report was originally prepared by Gregory J. Prelewicz of Fairfax Water for Dr. Mark M. Houck, P.E., of George Mason University as part of a course requirement for Civil, Environmental, and Infrastructure Engineering in May of 2004. The report has been expanded and modified by the Interstate Commission on the Potomac River Basin, Section for Cooperative Water Supply Operations on the Potomac. Funds were provided for this report by the Washington Suburban Sanitary Commission, the Washington Aqueduct Division of the U.S. Army Corps of Engineers, and the Fairfax Water. The opinions expressed are those of the authors and should not be construed as representing the opinions or policies of the United States or any of its agencies, the several states, the Commissioners of the Interstate Commission on the Potomac River Basin, or the water utilities.

The Potomac Reservoir and River Simulation Model (PRRISM)

A User's Guide and Documentation



Acknowledgements

Decades of work by countless water resources professionals at many agencies has gone into building the simulation model that PRRISM is today. While it is impossible to acknowledge every individual who has been involved with the model's development over the years, some of these individuals involved with its evolution include:

Jim Crews
Harry Schwarz
Richard Palmer
Daniel Sheer
Stuart Schwarz
Jim Smith
Roland Steiner
Gregg Nelson
K. John Holmes
Joe Trungale
Bill Haines
Robert Etris
Julie Kiang
Erik Hagen

On the cover (from left to right): the Triadelphia Reservoir, the Jennings Randolph Reservoir and Potomac River watershed; Images from WSSC, ICPRB, and FCWA.

List of Acronyms

Aqueduct = Washington Aqueduct Division of the US Army Corps of Engineers (COE)

ASCE = American Society of Civil Engineers

BG = Billion Gallons

COE = U.S. Army Corps of Engineers, Baltimore District

CO-OP = Cooperative Section for Water Supply, ICPRB

FCWA = Fairfax County Water Authority

ICPRB = Interstate Commission on the Potomac River Basin

JRR = Jennings Randolph Reservoir

LFAA = Low Flow Allocation Agreement

LP = Linear Programming

MGD = Million Gallons per Day

MWCOG = Metropolitan Washington Area Council of Governments

PRISM = Potomac River Interactive Simulation Model

PRRSIM = Potomac River and Reservoir Simulation Model

RO = Reverse Osmosis

Q = Discharge (or Flow)

SRR = Savage River Reservoir

UPRC = Upper Potomac River Commission

WMA = Washington, D.C. Metropolitan Area

WPA = Works Progress Administration

WS = Water Supply

WSCA = Water Supply Coordination Agreement

WSSC = Washington Suburban Sanitary Commission (WSSC)

WTP= Water Treatment Plant

WWTP = Wastewater Treatment Plant

Background

Three agencies, the Washington Aqueduct Division (Aqueduct) of the US Army Corps of Engineers (COE), the Washington Suburban Sanitary Commission (WSSC) and Fairfax Water (FCWA), provide the majority of potable water to the Washington, D.C. metropolitan area (WMA).

The freshwater Potomac, Patuxent, and Occoquan Rivers upstream of the Washington Metropolitan Area drain almost 15,000 square miles, spanning a four state area (Virginia, Maryland, West Virginia, and Pennsylvania) and the District of Columbia. Today, thanks to integrated and cooperative efforts among the water utilities, the Potomac, Patuxent and Occoquan river systems are operated to meet the region's water supply during periods of low flow. A series of decisions, occurring over several decades, led to the evolution of the riverine management system currently in-place.

In the decades following World-War II, including the present, the WMA experienced rapid population growth (even larger than national average, during the baby boom era for the country as a whole). The increased water demands imposed on the region as a result of this growth prompted the U.S. Army Corps of Engineers (COE) to conduct several water supply studies of the Potomac River (U.S. COE, 1961 and 1963). The studies recommended the construction of 16 major reservoirs and 418 smaller multi-purposes reservoirs in the Potomac River basin (U.S. COE, 1963). Ultimately, only one of the reservoirs in the original COE report was constructed.

The need to address water supply purposes in the WMA was brought into public notice during the drought of 1966 during which local jurisdictions imposed mandatory and voluntary restrictions. While the restrictions were primarily distribution system related, editorial articles called for regional leaders to find solutions as projections showed that 1980 demands would exceed Potomac river flows experienced during the summer of 1966 (Washington Star, 1966).

Planning efforts by the COE, the Interstate Commission on the Potomac River Basin (ICPRB), FCWA, WSSC and others continued during the 1970s. By the mid-1970s, local support for the reservoirs proposed by the COE waned, and the COE stopped their consideration. FCWA and WSSC set planning priorities for their systems: FCWA desired to construct a water treatment plant on the Potomac River, and WSSC sought to construct a weir to serve their Potomac River intake. Through the efforts of the managers of the utilities¹, regional consensus was built for a cooperative management approach, allowing all agencies to benefit. The three jurisdictions, the states, and the Federal government signed a Low Flow Allocation Agreement (LFAA) in 1978 to govern withdrawals during drought periods. In September 1977, John Hopkins University was awarded a grant from the US Department of Interior, with support from the ICPRB, the Commonwealth of Virginia, and the State of Maryland, to develop and analyze potential operating policies for the WMA. During the first year of the 2-year study, investigators relied on linear programming (LP) models to find an optimal water supply strategy. Initial results of the LP models indicated that significant gains could be realized through co-operative management of the system's resources (DOA, 1983). However, in order to incorporate effectively the provisions of the LFAA and to allow the user to test various operating strategies, the second year of the study focused on the development of a hydrologic simulation model. The research team developed the Potomac River Interactive Simulation Model (PRISM). The model was designed to simulate operation of the river and reservoir system during a drought situation. In 1979, ICPRB formed the Section for Cooperative Water Supply Operations (CO-OP). The CO-OP was established as a forum for the utilities to work together to operate the system and realize the synergistic effects

¹ Robert S. McGarry, General Manager of WSSC; James J. Corbalis Jr., Engineer-Director of FCWA; and Harry Ways, Chief of the Washington Aqueduct

of a system managed collectively for the WMA. Thus, the CO-OP began building upon and maintaining the PRRISM model. In 1982, a Water Supply Coordination Agreement (WSCA) was signed between the water supply agencies, the federal government, and ICPRB. The WSCA calls for the coordination of major facilities amongst the utilities to limit the potential for triggering the LFAA. This was accomplished through regional cooperation, in particular by holding 'local' reservoirs at full storage at the beginning of a drought period. Modeling runs demonstrated that gains in efficiency would result if the water utilities' independent systems were managed as one system, including the off-Potomac Occoquan and Patuxent reservoirs. The main source of benefit is the water utilities use of the Potomac during critical winter and spring periods to allow the Patuxent and Occoquan reservoirs to remain full for the summer low-flow periods (Palmer et al., 1982).

The model has been continually updated to reflect the planning needs of the water utilities and others. The crux of the original model has evolved from a FORTRAN based model to an object-oriented model using the EXTEND™ software environment. The EXTEND based version model, now known as the Potomac Reservoir and River Simulation Model (PRRISM), was developed by the CO-OP section of ICPRB (Hagen, 2004) in the late 1990s. New system components and analysis have been added as needed to support planning and modeling work for the water utilities.

Today PRRISM is a deterministic continuous simulation model that is regularly updated to reflect system parameters, improvements in methodology, and updated demographic forecasts. As called for in the LFAA (and carried out by the CO-OP section of ICPRB), the water suppliers are committed to reviewing and evaluating the adequacy of the available water supply. The benefits of such iterative water supply adequacy analysis in the WMA are more fully discussed by Hagen, et al. 2004.

Early Modeling Methods

The early research conducted at Johns Hopkins University considered both simulation and linear programming models in developing routines to optimize the Potomac riverine and reservoir system. Palmer et al. (1982) discuss the two generalized approaches applied to the WMA for determining single and multi-reservoir yields. Specifically, they discuss their two primary approaches: the Hypothetical Reservoir formulation, a simulation technique, and the Optimal Integration Procedure, a linear programming formulation. In addition, they constructed a detailed separate linear programming formulation to perform a multi-objective analysis of conflicting water-use objectives in the WMA. Comparisons between simulation and linear programming methods showed that for several formulations of interest, results obtained from the simulation proved equally effective to that of linear programming. With the ability to incorporate more easily the terms of the LFAA, and the ability to test various operating strategies and policies, simulation ultimately became the tool of choice for modeling of the Potomac River. Schwartz (2000) has more recently discussed the LP approach and its application to the WMA system.

The early work done on Potomac River modeling was influential not only because of the tremendous resources saved by optimizing the existing system of reservoirs, but also in the larger water resources profession. The planning and management work related to the WMA was a 1983 nominee for the American Society of Civil Engineers (ASCE) Outstanding Civil Engineering Achievement (Scheer and Flynn, 1983). Some of the techniques applied to the WMA were built on operations research done in the power industry (Scheer, 1983). Such systems made use of forecast and simulation models to help schedule operations and improve power output (Scheer, 1983).

EXTEND

Having established simulation as the candidate tool for modeling the Potomac River system, a software environment that allows maximum user flexibility and graphical user capabilities was desired when 'upgrading' the original simulation model (Hagen, 2004a). The original PRISM model was written in FORTRAN 77. In the late 1990s, the CO-OP section of ICPRB undertook the effort of converting FORTRAN code into blocks in the EXTEND software program. EXTEND, developed by Imagine That Systems of San Jose, CA, provides a customizable environment with the ability to handle complex sub-models, such as those found in the Potomac system. Elements are created as blocks of icons, each of which contains a simple calculation or complex algorithm. Blocks are linked together in a logical flow to replicate the system of operations. Inter-process communications allow EXTEND to import and export data to and from external files. For instance, flow values in a tab delimited format are read into an EXTEND block. A spreadsheet file named PRRISM.xls is used by the PRRISM model to receive output from the model, providing a concise summary of the simulation results.

Water Supply Resources of the Potomac River System

The water supply resources of the Potomac River system are shown on page 5.

Jennings Randolph Reservoir

The Jennings Randolph Reservoir (JRR), originally named Bloomington Lake but renamed in 1990 in honor of longtime West Virginia Senator William Jennings Randolph, impounds 13.4 billion gallons of water for the WMA water suppliers. In addition, another 16.6 billion gallons of water is dedicated to water quality improvement. Congress authorized Bloomington Lake under the Flood Control Act of 1962 (Public Law 874). The construction of JRR, begun in 1971 and completed in 1981 under the supervision of the COE, was the recipient of an ASCE Outstanding Civil Engineering Award of Merit (Peck, 1982). Located on the North Branch of the Potomac River approximately 200 miles upstream of the WMA, the JRR is operated for water quality and water supply benefits by the COE. The drainage area of the JRR is approximately 263 square miles (ICPRB, 1998). The JRR serves as the WMA's primary source of stored raw water. Releases are directed by the ICPRB CO-OP based on existing and projected utility demands, the status of other reservoirs, and hydrometeorologic forecasts. As a primary water supply source for the WMA, JRR is used to augment Potomac River Flow during periods of low-flow. The three major water suppliers agreed to pay for storage in JRR along with the annual operating and maintenance costs.

Savage River Reservoir

The Savage River Reservoir (SRR), owned by the Upper Potomac River Commission and presently operated by the COE, lies in the North Branch Potomac River watershed. Construction on the original dam was started in 1939 under the Works Progress Administration (WPA) program with additional funding from the Upper Potomac River Commission (UPRC) but suspended because of World War II from December 1942 to March 1949. It was completed under the supervision of the COE in 1952. The SRR, with a capacity of 6.5 BG, is used for water quality improvement, to provide flow-by for industrial processes, flood control, and to dilute relatively acidic flows in the North Branch of the Potomac. While no storage in SRR is directly dedicated for water supply purposes, the SRR's water quality operations are simulated in PRRISM as part of the North Branch Potomac sub-model.

Little Seneca Reservoir

In 1985, the WSSC completed construction of the Little Seneca Creek Dam and Reservoir in northwestern Montgomery County, MD. The reservoir, operated by WSSC under a cost-sharing agreement with the FCWA and the Aqueduct, is available to supplement flows in the Potomac River during dry periods. With a capacity of 3.8 billion gallons, the proximity of Little Seneca

Reservoir to the WMA water supply intakes results in travel times of 12-24 hours. Thus, Little Seneca Reservoir provides valuable operational flexibility to the water supply system by allowing the 'fine tuning' of larger releases from JRR to meet WMA water supply demands and environmental flow-by targets during low-flow periods.

Occoquan Reservoir

The FCWA owns and operates the Occoquan Reservoir in Fairfax and Prince William Counties, VA. Constructed in 1957, the Occoquan 'High' Dam (so named because it is upstream of a lower head dam constructed on the Occoquan in 1950) was raised by 2' in 1982. The Occoquan Reservoir, with a drainage area of approximately 592 square miles, provides 8.1 billion gallons of usable water supply storage. The Occoquan currently serves three treatment plants in the southern part of FCWA's service area with a combined treatment capacity of 112 mgd. The Reservoir will be the raw water source for the soon to be completed Frederick P. Griffith, Jr. Water Treatment Plant (WTP), with a capacity of 120 mgd (ultimate 160 mgd) located in Lorton, VA. As the primary raw water source for FCWA until 1981, FCWA can utilize and pump water from the Occoquan to meet average daily demand for all of its retail and wholesale customers. Today, FCWA uses the Occoquan in combination with the Potomac River to meet its customers' water supply demands.

Patuxent Reservoir

WSSC owns and operates the Triadelphia and Rocky Gorge reservoirs in the Patuxent River watershed. Impounded by the Brighton Dam and T. Howard Duckett Dam respectively, the combined usable storage of the Patuxent Reservoirs is 10.2 billion gallons. Together Brighton Dam, completed in 1943, and Duckett Dam, completed in 1952, served as WSSC's primary drinking water source during the late 1940s and 1950s. The watershed area draining to the reservoirs is a combined 132 square miles. The utility uses the reservoirs to serve its 72 MGD Patuxent WTP. The plant is currently undergoing renovation, and will eventually have an emergency capacity of 120 MGD. Today, WSSC uses the Patuxent WTP throughout the year in combination with the larger Potomac WTP to meet its customer's water supply demands.

Potomac River

The WMA CO-OP water suppliers operate three major WTPs that utilize raw water from the free-flowing Potomac River. The intakes are located approximately 15-20 miles upstream of Washington D.C. The three major facilities are:

- WSSC's Potomac River WTP in Potomac, MD, with a current rated capacity of 285 MGD, although 240 MGD is perhaps closer to its actual capacity.
- FCWA's James J. Corbalis, Jr. WTP in Herndon, VA, with a current capacity of 150 MGD, with a planned expansion to 225 MGD.
- The Washington Aqueduct, a historic landmark in civil engineering that opened in 1863, serving the Dalecarlia WTP in upper Northwest Washington D.C. and the McMillan WTP, in Northwest Washington D.C. The Dalecarlia and McMillan WTPs have a combined capacity of 320 mgd.

These three facilities together are the major drinking water withdrawals on the Potomac River in the WMA. PRRISM also simulates water supply withdrawals by the City of Rockville, MD, at their intake in Potomac, MD.

The service areas for the Washington Metropolitan Area Water Suppliers and Distributors are shown on page 6.

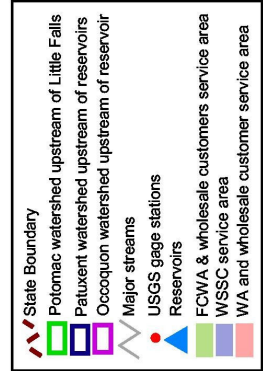
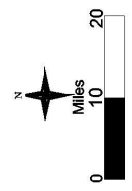
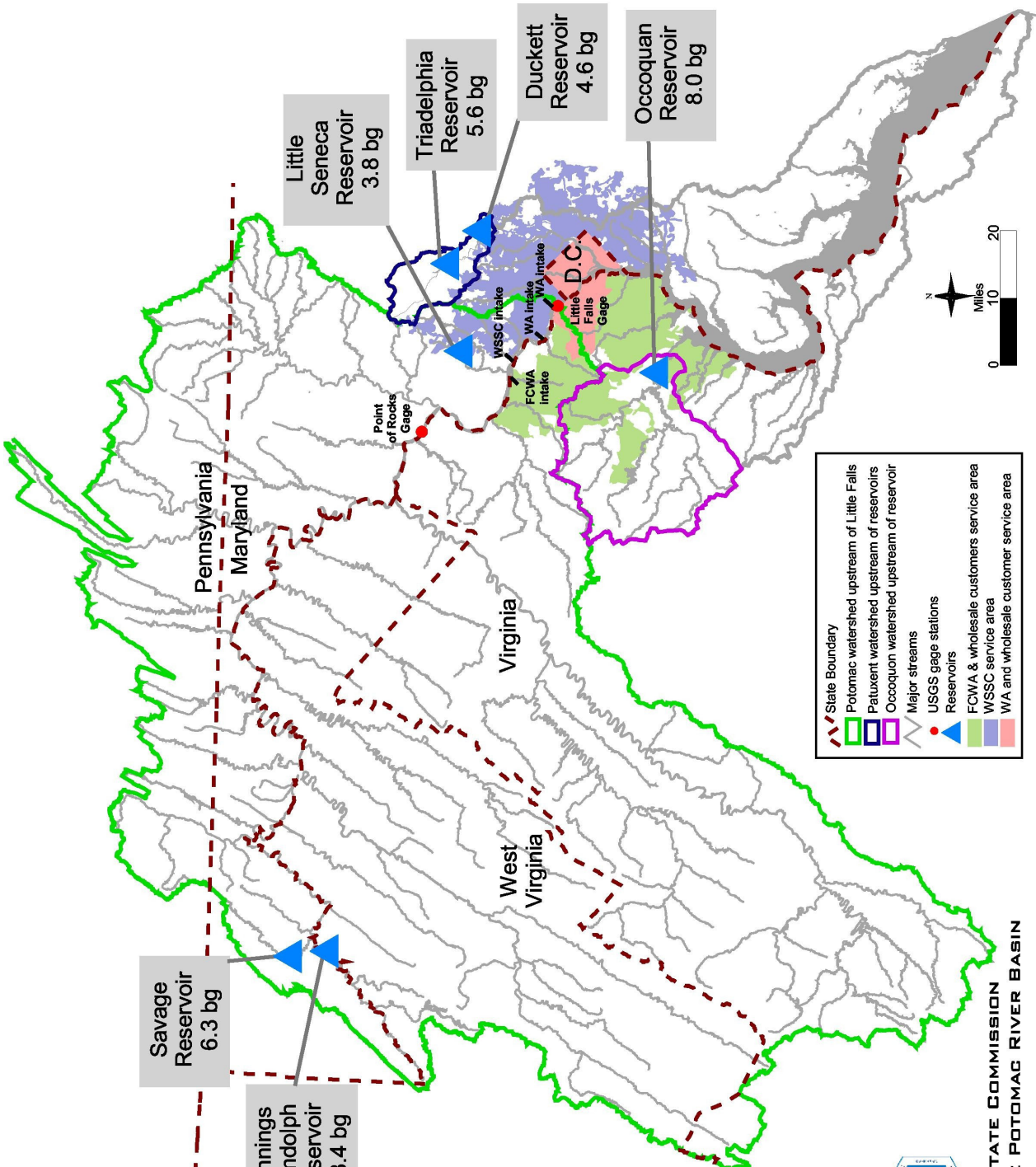

**INTERSTATE COMMISSION
ON THE POTOMAC RIVER BASIN**

Service Areas for Washington Metropolitan Region Water Suppliers & Distributors

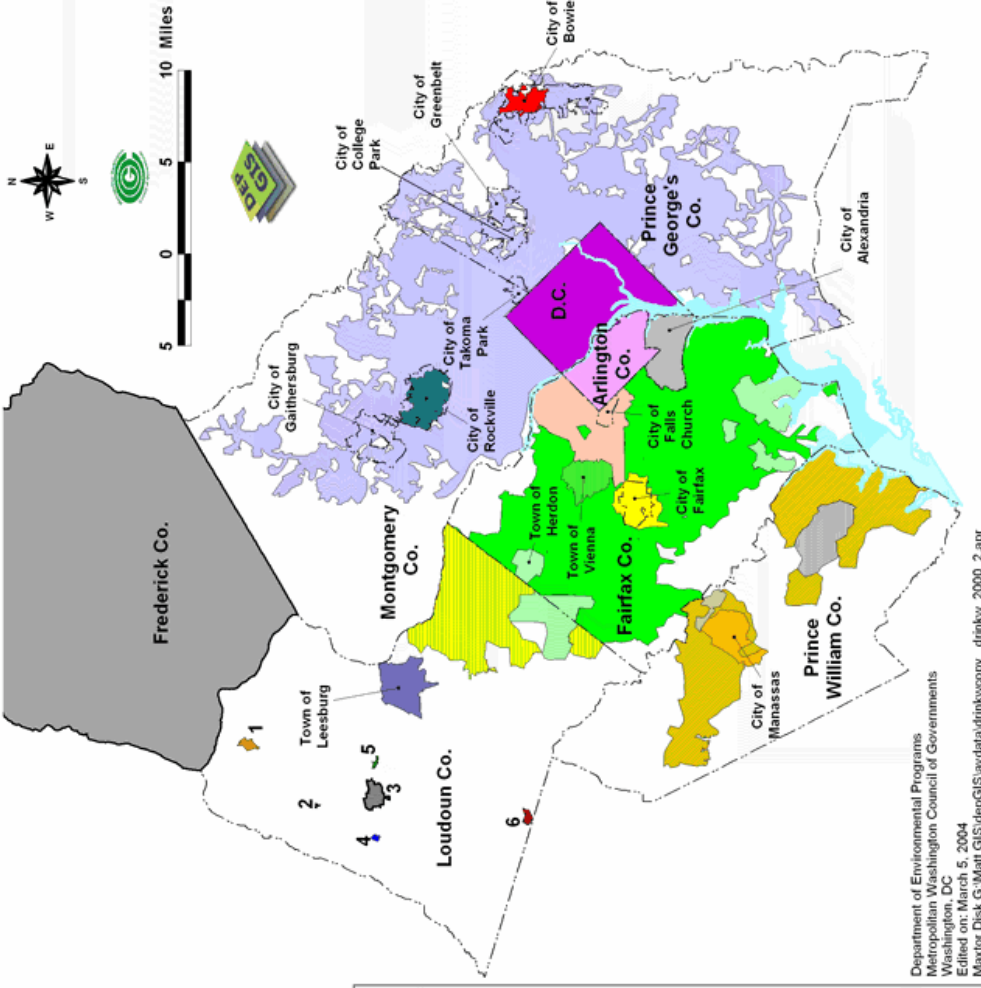

The various colored areas depict the extent of the areas in which water from the water supply and distribution agencies are available. These distribution areas should be interpreted with the following caveats:

- there may be people living in the colored distribution areas who derive water from ground water wells
- people living in the non-colored areas outside of the distribution regions may derive their water from groundwater wells or small community systems
- the boundaries of most distribution areas were last updated in ICPRB in 2000 Supply/Demand study

Business or residents should not use this map to establish whether they derive water from a particular treatment agency.

- LEGEND**
- Jurisdictional Boundaries
 - Drinking Water Suppliers & Distributors
 - City of Bowie DPW
 - Fairfax County Water Authority
 - Fairfax County Water Authority (Small Wholesale)
 - Loudoun County Sanitation Authority
 - Prince William County Service Authority
 - Virginia-American Water Company
 - Vienna DPW
 - City of Fairfax DU
 - Loudoun County Sanitation Authority
 - City of Manassas DU
 - City of Manassas Park DPW
 - Town of Lovettsville
 - Town of Hillsboro
 - Town of Purcellville
 - Town of Round Hill
 - Town of Hamilton
 - Town of Middleburg
 - Town of Leesburg
 - Washington Aqueduct (COE)
 - Arlington DPW
 - District of Columbia Water and Sewer Authority
 - Falls Church DES
 - Washington Suburban Sanitary Commission
 - City of Rockville
 - Frederick County Utilities and Solid Waste
 - Areas not served by public utility

Department of Environmental Programs
 Metropolitan Washington Council of Governments
 Washington, D.C. 20005
 Edited: March 5, 2004
 Mapper Disk G:\Matt GIS\dep\GIS\ard\data\drinkcopy_drinkv_2000_2.apr

Improvements to the Model

Over time, the assumptions used in PRRISM have been refined to reflect new empirical data. For instance, releases from the JRR were once thought to require approximately five days to reach the Washington D.C. area (Trombley, 1982). Through analysis and observation of low-flow periods such as in 1999, the travel time is now estimated to be nine-days during low-flow situations (Hagen, et al. 2004). Over the last several years, various submodels have been added to the model including: the North Branch water quality operations, Lake Manassas, and the Occoquan Estuary Membrane Treatment Plant option. Other improvements include the ability to simulate the effect of water restrictions, determine the sensitivity of the system to different daily demands, and assist with resource analysis (Hagen et al., 2004).

The Future of the Model

PRRISM is a dynamic model, adapted to reflect the most current information available on the Potomac system. PRRISM has enabled ICPRB to respond to questions about the physical system, regulatory issues, and environmental and water supply related questions (Hagen et al., 2004). Given the flexibility of the EXTEND environment, the model can be easily modified to incorporate new operational changes and proposed facilities. To facilitate changes, the CO-OP section of ICPRB maintains the model using the current date to reflect a change in status rather than a specific version number (i.e...12-30-2004 rather than v5.1). Of course, previous versions of the models are archived before major changes are made and the flexibility of the EXTEND environment allows various blocks to be easily turned on and off. Thus, the CO-OP section can easily change assumptions and inputs to meet the planning needs of the water utilities.

The Programming Level

The EXTEND environment allows the model code to be easily viewed and modified. Built in 'object oriented' code, model blocks are small icons or labeled boxes. Each box or icon has a specific function, and often double-clicking a particular block will reveal additional layers of blocks or text. This manual illustrates many, but not all, of the major blocks in PRRISM.

Note About this Manual

This manual contains annotated screen shots of the Model. The annotations, in the form of callouts, are designed to provide additional information, or in some cases, point out specific blocks. The user should note that because PRRISM is a dynamic model (as mentioned above), today's screen shots might look slightly different than shown in this manual.

Section 1 - The Notebook & User Inputs

The Notebook provides the primary user interface for changing the most common simulation parameters. The Notebook allows the user to run the model, select inputs, and view results in a simple and straightforward manner. Dialog boxes, windows, and scroll bars, common to the Windows environment, are used in the interface.

While the notebook provides the tools to perform a high-level of planning analysis, the user should have a basic understanding of the system before making input selections. Specifically, the user should have some planning basis for providing inputs for the forecast year simulated. This section provides an explanation of each user input and references to further explanation. Annotated screen shots are used to provide additional notes on specific user inputs.

1.1 Restriction Triggers

The imposition of water restriction measures is assumed to have a temporary effect of reducing potable water consumptive uses. During periods of restriction, water conservation measures can be imposed on a voluntary, mandatory, or emergency basis. Restrictions apply to the Water Supply Demands of the WMA. Restrictions are imposed based on percentage of storage in the WMA water supply reservoirs, JRR or Little Seneca. Restriction triggers, or conditions that generate the beginning of a period of water conservation, begin when either JRR or Little Seneca reaches the user-defined threshold value. Three restriction levels are available to the user: voluntary, mandatory, and emergency.

Voluntary restrictions are suggested measures to reduce non-essential water use and may include: reduced lawn watering, car washing, and filling of swimming pools. A response plan endorsed by the Washington Metropolitan Area Council of Governments (MWCOG, 2000) calls for voluntary restrictions to be imposed when the combined storage in JRR and Little Seneca drops to below 60 percent full. This trigger level was implemented by ICPRB in the latest WMA demand forecast and resource availability analysis (ICPRB, 2000). Based on the WMA experience during the drought of 1999, voluntary restrictions can be assumed to reduce demands by 10 percent (ICPRB, 2000).

Mandatory restrictions are compulsory limitations on water for specific uses and would be imposed during a severe drought. ICPRB model runs have assumed that mandatory restrictions would be triggered when either of the storage in JRR or Little Seneca drops below 25 percent (ICPRB, 2000).

Emergency restrictions, the highest level of conservation measure, would be imposed only in the most severe drought during which reservoir storage is substantially depleted. During such conditions, water utility managers would implement such restrictions prior to total depletion in order to preserve some emergency storage volume.

The user should note that the LFAA sets for the three specific stages of flow in the Potomac River: Alert, Restriction, and Emergency Stages. Whenever the restriction or emergency stage is in effect, each user shall be allocated a specific portion of the available flow. The restriction triggers simulated in this block are independent of the LFAA stages, which would be implemented only when reservoir storage is depleted.

1.2 Forecast Year

PRRISM provides a planning tool by simulating future conditions for various scenarios of demand, historical flows, and system operations. Demand forecasts are a primary input in future

simulations. For the WMA consumptive demands, ICPRB currently conducts 20-year demand forecasts studies on a 5-year reoccurring basis. Demands beyond 20-years, currently through 2040, have also been estimated by ICPRB. Other demands in the system are also estimated for the same planning horizon. The most recent demand study was completed by ICPRB in 2000 (ICPRB, 2000). For more information on the ICPRB demand studies, see ICPRB report 00-06.

1.3 Forecast Alternative

Forecasts of future water demands have uncertainties associated with them. The 'most likely' forecasts are based on information provided by each WMA supplier and on the Metropolitan Washington Area Council of Governments (MWCOG) 'most likely' forecast. The 'high growth' forecast utilizes the MWCOG high growth demographic scenario. The forecast alternative switch allows for the simulation of either scenario. Forecasts of future water demands for the WMA are further discussed in ICPRB report 00-06.

1.4 Little Falls Forecast

To meet environmental flow-by targets at Little Falls, the Potomac River flow must be 'forecast' 9-days in the future. The 9-day time period corresponds to the approximate travel time for releases from the water supply storage in Jennings Randolph Reservoir to reach the WMA during a drought situation. Two different hydrograph recession methods are available to simulate receding Potomac River flows. The first method uses mainstem hydrograph recession equations using historical drought data from the Hancock gage. Tributary recession equations were developed for the tributaries downstream of Hancock, including the Conococheague, Antietam, Shenandoah, Monocacy and Little Seneca sub-watersheds. Predicted flow is the sum of Hancock flow plus area adjustment of the predicted flow from downstream tributaries. The second method uses mainstem recession equations based on drought year flows from Little Falls gages. The user can select between these methods.

1.5 Seneca Safety Factor

The relatively short travel time between Little Seneca and Little Falls allows releases from Little Seneca to augment releases from JRR, thereby increasing the operational flexibility of the system. A margin of safety, called the Seneca Safety Factor, is used in release operations because Little Seneca is the last augmentation available to meet Little Falls flow targets. The Seneca Safety Factor is the percentage of flow release added to the calculated Seneca release to account for losses between Seneca and Little Falls. The safety factor currently simulated by ICPRB is 30 MGD meaning that a 30 MGD 'cushion' will be added to the calculated release. For further discussion on how Little Seneca supports negative hedging releases for upstream augmentation storage, see Scheer (1982), Eastman (1986) and Schwartz (2001).

1.6 Prince William New Service Area

The Prince William New Service Area switch allows for the straightforward simulation of an additional 7 MGD consumptive use allocation by the Prince William County Service Authority. This demand would be supplied by FCWA's Griffith treatment plant on the Occoquan Reservoir. This demand is separated from the other water supply demands in the WMA to allow for analysis with and without this potential new service area.

1.7 New Power Plants

New consumptive demands from power plants can be easily modified through the 'New Power Plant' dialog box. ICPRB has used 8.3, 14.3, and 21.3 MGD as input values for this parameter to simulate the effects of three power plants that are proposed.

1.8 Load Shift

Load Shifting simulates a change in the operations of WSSC and FCWA to utilize more fully the Patuxent and Occoquan WTPs during certain time periods prior to or during a drought. The switch is established to turn on or off the simulation of load shifting, with the value of zero for no load shifting and the value of one for simulating load shifts.

A note about 'Load Shift' (and all other 0 or 1 switches): The user is cautioned to observe that by simulating load shifting (switch =1), load shifting is assumed as an 'operational norm' during all drought years. Likewise, not simulating load shifting will simulate the entire forecast period under this operation. This rule applies to all switches allowing values of either 0 or 1.

1.9 Delta Load Shift

To reflect the fact that operational limitations may prevent water production from being shifted from the Potomac River WTPs to the Occoquan and Patuxent River WTPs, the delta load shift input is used to control the amount of water produced at the Occoquan and Patuxent facilities. The delta load shift determines the maximum water production that can be shifted in any one day (in mgd).

1.10 Occoquan Hydropower

Power generation facilities at the Occoquan Dam can be simulated in the on (one) or off (zero) positions.

1.11 Daily Demand Patterns

Demand patterns of the WMA water supply system vary. The annual demand patterns of 1991, 1997, 1998 or 1999 can be simulated. The user should note ICPRB is in the process of updating this method. System demand will be a function of explanatory variables such as precipitation and temperature. These explanatory variables will become file inputs to the model, and water demands can be explicitly modeled.

1.12 Consumptive Demand

Total consumptive demand can be simulated to hold constant at 2020 levels, no matter the forecast year.

1.13 Reset July storage

This switch allows for the simulation of the Occoquan and Patuxent Reservoirs in a non-continuous mode, automatically reverting to 100% capacity on July 1st. The model is typically run in a continuous mode, however. This switch is used to place an outer bound estimate of benefits to operating rules that encourage refill of the Occoquan and Patuxent Reservoirs to 100 percent full. Operationally, water production would be shifted to the Potomac River WTPs early in the summer to allow the Occoquan and Patuxent to refill to 90 percent full, 95 percent of the time.

1.14 User Inputs – North Branch

The North Branch User Inputs refer to parameters of interest in determining the COE operation of the SRR and JRR to meet various water quality, water supply and recreational objectives.

Mead Westvaco Color

The user can enter the monthly average color (units of PtCo) permitted end-of-pipe discharge at the Mead Westvaco Plant in Luke, MD, along with a future color standard (in PtCo) 1 mile downstream of the plant.

May Releases-Jennings

This option allows for the simulation to assume that water quality releases from JRR will be reduced slightly if the beginning of year (Jan-May) conditions indicate that a drought year is imminent.

Savage 20% Match

The option allows for the simulation of SRR to match 20% of water supply releases from JRR if sufficient water is available in SRR.

Savage Whitewater

This input allows for whitewater recreation releases from SRR to be simulated in the 'on' or 'off' position. The on position allows for whitewater releases in September of each year if Reservoir water levels are available.

Luke Minimum Flow Target

The minimum flow target for the months of January, February and March is a user input.

September 1 Boat Ramp Target

The option allows for the September 1st Boat Ramp target at JRR and SRR to be met in all years (1) or only in years in which water supply releases do not occur (0).

1.15 User Inputs – Membrane

The User Inputs-Membrane Inputs refer to the simulation of the entire system with the addition of an Estuary Membrane Treatment Plant on Occoquan Bay. The Occoquan Estuary plant would be used to supplement water capacity during drought situations. The Membrane Treatment module was developed in PRRISM in conjunction with a study conducted for the FCWA (CDM, 2001). Three user inputs are available in the notebook:

- Size of Plant: The planning study evaluated in two potential design sizes: a 25 mgd and a 50 mgd facility
- June – July 15 Operations: Two different operational modes can be simulated: 'Waiting' to begin operation until Mid-July (1), or allowing operations to begin June 1 (0).
- After July 15th, the Membrane plant can be begin estuary withdrawals under one of the following modes:
 - When storage in either JRR or Little Seneca falls below 60%
 - When withdrawals on the Potomac would trigger the release of storage to meet low flow targets at Little Falls
 - No operation after July 15th (Note - This effectively 'turns off' the Membrane Treatment Plant)

Figures 1-1a and 1-1b illustrate the primary inputs of the Notebook.

Figure 1-1a. The PRISM Notebook – User Inputs

User Inputs

User inputs - green background
Results - gold background

Restriction Triggers

Percentage full, Jennings Randolph or Little Seneca

voluntary:	0.6
mandatory:	0.25
emergency:	0.1

Forecast Year

Range 2000 to 2040:

2020

Forecast alternative

Set the switch to choose "most likely" or "high forecast" alternative:

Zero = most likely
One = high forecast

Percent Demand Reduction

(Assumes no reduction in demand November through April)

	% demand reduction May and October	% demand reduction June through Sept.
voluntary	0.05	0.05
mandatory	0.05	0.1
emergency	0.1	0.15

Maximum change per timestep

0.005

Storage loss, mg per year

Ocoquan	40
Patuxent	24
Seneca	15
Savage	18
Jennings	44

Little Falls Forecast

0 - mainstem regression
1 - tributary regression

Prince William new service area

0 - Existing service area
1 - Existing plus new service area

New power plants

Enter the total consumptive use of the new power plants:

	2
--	---

8.3 14.3 21.3

Reset July storage

Ocoquan and Patuxent
1 - reset
0 - continuous

Load shift

0 - no load shifting
1 - yes load shifting

Delta load shift, mgd

Patuxent and Ocoquan

30

Ocoquan hydropower

Turn off Ocoquan hydropower generation by turning switch to zero:

Zero = generators off
One = generators on

Daily demand patterns

Test the sensitivity of the system to different annual demand patterns
1)1991; 2)1997; 3)1998; 4)1999

2

Consumptive demand

note that this should be set to "1" for almost all runs.

0 - constant 2020 levels of consumptive demand
1 - variable consumptive demand as a function of forecast year

Seneca safety factor

Factor of safety added to the Seneca release.

30

Figure 1-1b. The PRISM Notebook – User Inputs (Continued)

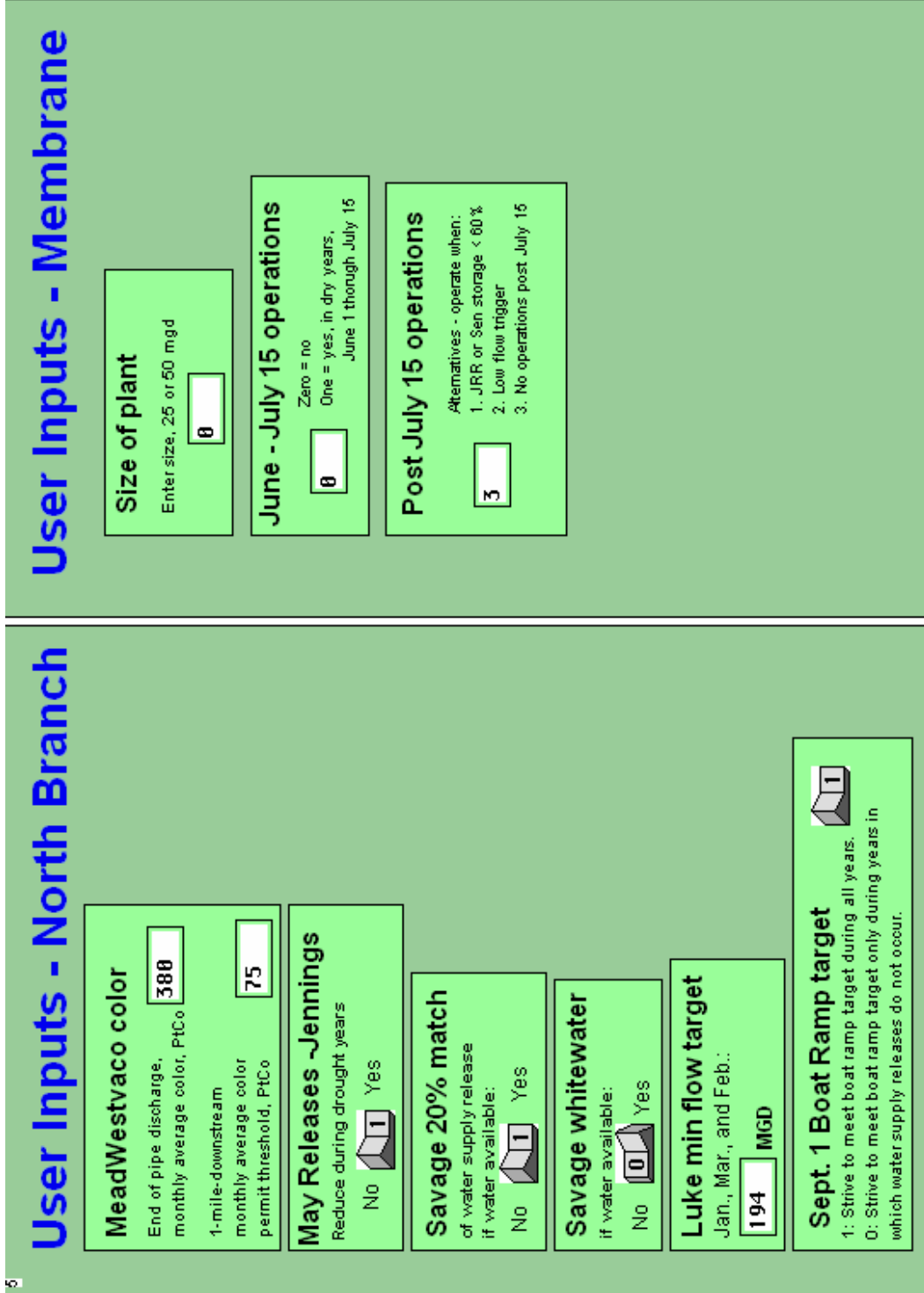

Section 2 - Model Timestep and User Inputs

2.1 Model Timestep

The model timestep block allows the model to handle daily simulation in a Julian date format. Specifically, this block was created to handle Leap Year when an extra day must be added. This block also outputs the day as a month plus fraction number. For instance, January 15th is represented as 1 plus (15/31 = 0.483871) or 1.483871. These calculations are carried out in the Model timestep block, shown in Figure 2-1. Decimal representation of the day as a fraction of the month is used for many of the calculations in PRRISM.

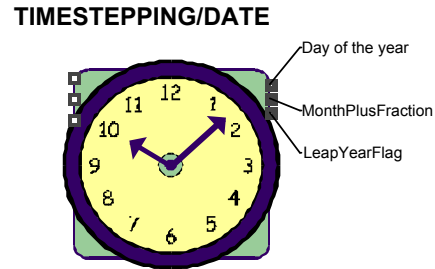
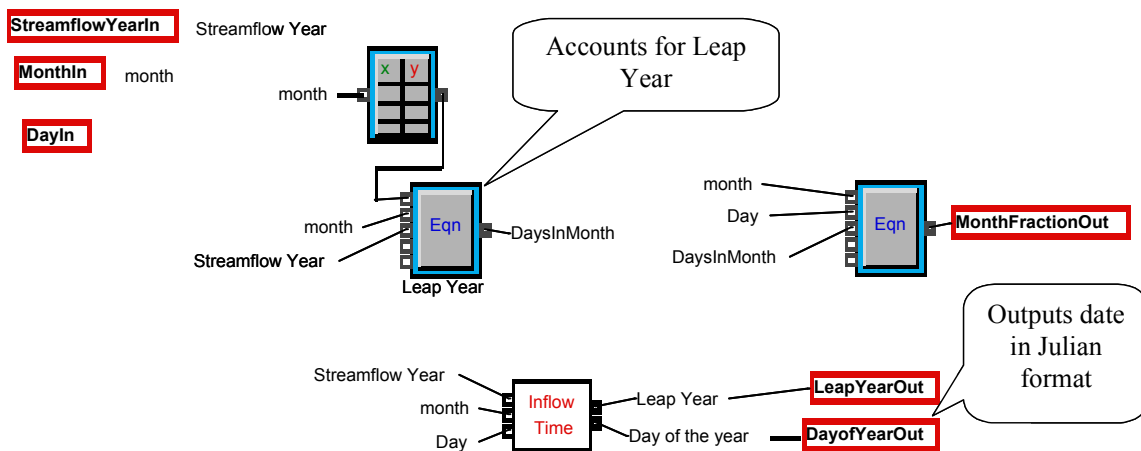

Figure 2-1. The Model Timestep



2.2 The Input Files

The 4 major input files used to drive the model are highlighted below.

1. The **systeminflowsandriverq.txt** serves as a primary input for the historical flows. The data are compiled in tabular form and delimited by tabs. Beginning in October 1929, daily inflow values are compiled for the following watershed and gages: Jennings Randolph, Savage River, Occoquan, Seneca, Patuxent, Point of Rocks with North Branch, and Potomac River flow between Point of Rocks and Little Falls. Development of historical flows at these locations is documented in ICPRB reports 98-3, 98-4a, and 98-5 and in the model itself.
2. The **systeminflowsandriverq2.txt** file contains the gaged flow at Luke, MD. The data are compiled in tabular form, beginning in October 1929, and are delimited by tabs.
3. The **corpinput.txt** file, developed from COE data records, contains inflow, outflow and storage levels for the Savage River and Jennings Randolph reservoirs, along with North Branch flow near Kitzmiller, MD.

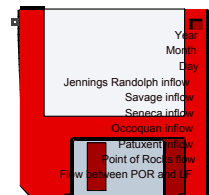

4. The **corpsinputhybrid.txt** file is a hybrid of CorpInput.txt in that some of the data identified by the COE as unknown or missing (values of -999) are replaced by values from the ICPRB inflow data set. The file contains many of the same data fields as that of corpinput.txt.

Section 3 - Water Supply Demands and the Potomac River

The simulation of the Water Supply Demands allows for the consideration of different annual demand patterns. Specifically, annual demand patterns from 1991, 1997, 1998, and 1999 can be evaluated. Daily Demand factors for each day of the selected year are then multiplied by the base year demand to 'normalize' them to the base year time period.



The City of Rockville demands are factored into this, along with a potential additional demand from Prince William County (FCWA demand). For more information on the switch to simulate this demand, see Section 1.6 (Notebook).

Either an average or high growth demand can be simulated. For more information on the switch to simulate this demand, see Section 1.3 (Notebook).

Two calculations of Potomac water supply demand and environmental flow-by requirements are provided to simulate the effects of a seasonal Occoquan Membrane treatment plant. Potomac water supply demand is calculated 1) with a seasonal membrane plant operation and post-June release, and 2) using the 'normal' rule curve for Griffith (Occoquan) production (membrane plant not in operation). This is shown in Figure 3-1.

Figure 3-1. Water Supply Demands

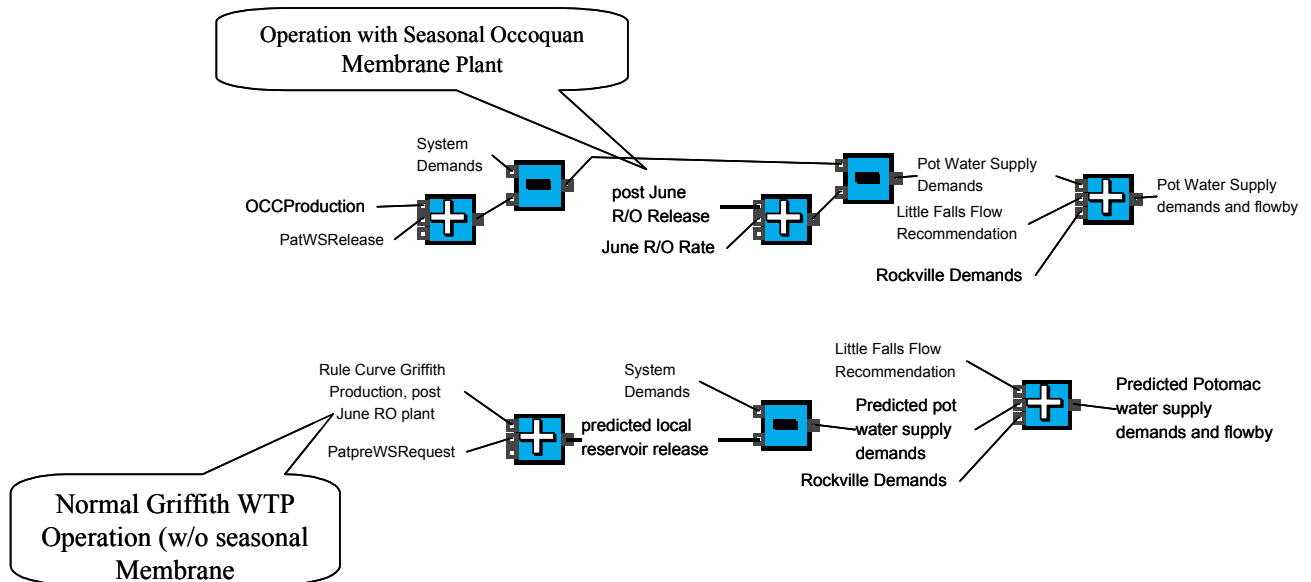

3.1 Estimating 9-day Demands

The travel time necessary for releases from the water supply storage in Jennings Randolph Reservoir to reach the WMA during a drought situation is approximately nine days. Therefore, WMA water demands must be estimated nine days out in order to determine whether Potomac river flows (unaugmented by water supply releases) are sufficient to meet consumptive demands and environmental flow-by requirements.

An estimate of the nine-day demands is developed using a centered 20-day historical rolling average demand. Thus, for a given time step, the estimate considers a historical average (i.e. 1991, 1997, 1998, and 1999 patterns) of demands 10-days prior to and 10-days beyond the current calendar date. These values are increased by the factor over the base year demands to account for the simulation year. The effect of demand reductions from any restrictions that may be imposed are considered as well. The PRRISM blocks used to estimate nine-days demands are shown in Figure 3-2.

Figure 3-2. Estimating 9-day Demands

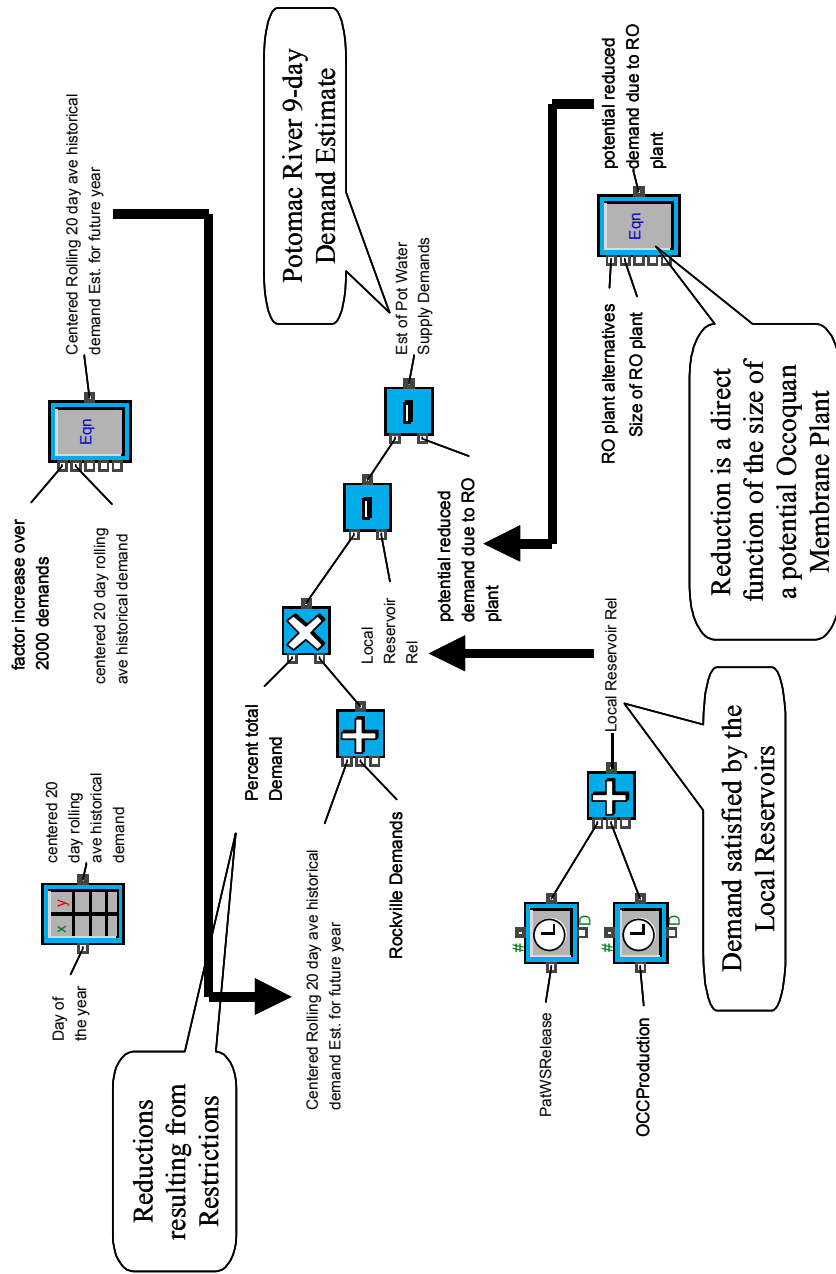

3.2 Natural Flows on the Potomac in 9-day time

PRRISM estimates 'natural' flows, flows without any contribution from upstream releases, on the Potomac River upstream of Little Falls. To determine this, historical streamflows are read from a User Input file. Historical streamflows, maintained by ICPRB in a file called *determine.release.txt*, are read for the following locations/gages:

- Hancock without North Branch flow
- Conococheague
- Antietem
- Shenandoah
- Monocacy
- Little Seneca

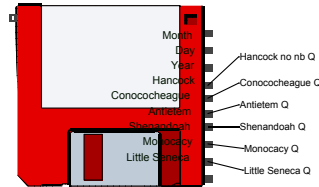

The influence of the JRR and SRR watersheds on the Potomac River flow is determined by subtracting the rolling average (of four, five, and six days) prior flow contribution from the North branch. The method from performing this calculation on the historical record differs between 1929 and 1949 where the North Branch gage at Luke was not yet established. For this time period, the Savage River and North Branch flows at Bloomington are added together as an estimate of this flow. Below Point of Rocks, the natural flow is estimated using the gaged flow from the Monocacy River and Goose Creek. Drainage adjustment factors are applied to represent the broader watershed (The factor is 2.08).

Using the input streamflows discussed above, an estimate of flow several days out is made using regression equations developed for each subbasin. For instance, analysis of historical flows indicate that during dry periods, the flow of the Conococheague can be estimated four days into the future through the use of the following equation:

$$0.769*q+5.78$$

where *q* is the current time steps flow (in cfs).

Similar regression equations are maintained by ICPRB for the other sub-basins.

The flows upstream of Point Rocks (Conococheague, Antietem and Shenandoah) are added together to simulate Point of Rocks flow in five days time. Note that a calibration factor (1.4) is applied to the Antietem and Conococheague due to geologic differences in the sub-basins. This calibration factor was applied to specifically calibrate for the flows received from these basins during the drought of 1966.

Finally, the simulated Point of Rocks and the simulated 'local' flows are added together to develop an estimate of the flow at the Little Falls in nine-days time.

3.3 Potomac WQ Augmented Flow

Having estimated the natural flow in the Potomac without the influence of the upstream reservoir watersheds, water quality related releases from JRR and SRR are added to the 'natural' flows to simulate the Potomac water quality augmented flow. The releases from JRR and SRR are delayed by 9 days to account for the travel time in reaching Little Falls. Figure 3-3 shows the blocks that calculate water quality augmented flow.

Figure 3.3. Potomac Water Quality Augmented Flow above Little Falls

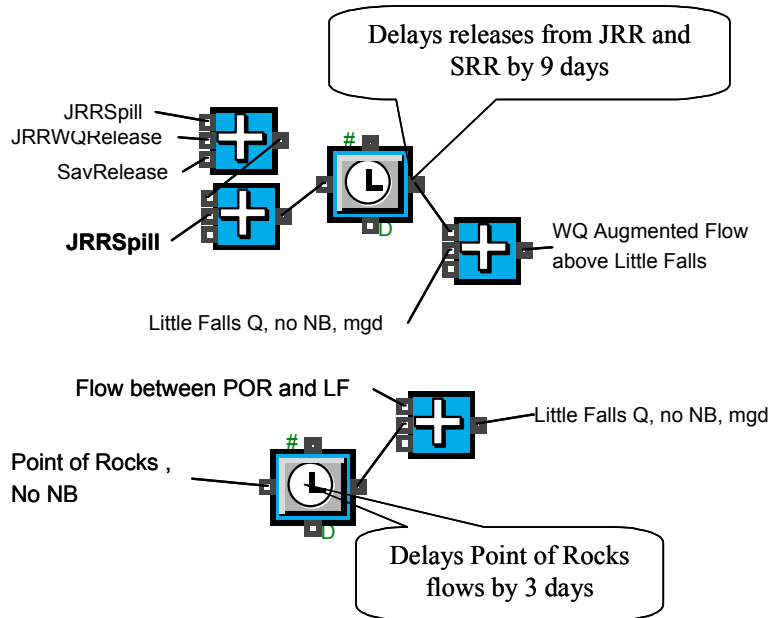

3.4 FCWA Distribution System Requirements

FCWA can produce water withdrawn from the Potomac River at its Corbalis Water Treatment Plant and the Occoquan Reservoir at its Griffith Water Treatment Plant. During a drought situation, certain distribution system requirements must be considered in the operation of the combined system withdrawals. These considerations are driven by the ability to distribute water to all of FCWA's retail and wholesale customers.

The distribution system requirements that are considered in PRRISM include:

Plant Capacity

The maximum production rate for the Corbalis and Griffith treatment plant are input. This is function of simulation year with maximum capacity of Corbalis set at either 150 or 225 mgd and Griffith at 120 or 140 mgd. The calculation includes a minor loss for production, a variable that can be set by the user. A 5% production loss rate is a typical factor applied for this loss.

Service Area and Production Requirements

A maximum transfer from West (Corbalis service area) to East (Griffith service area) is established to simulate distribution system requirements. The maximum transfer can be user input, with 65 mgd being a typical simulation value. The transfer from East to West is unlimited.

A tabular estimate of future fraction of total system demand that occurs within the Potomac source service area is used for Potomac and Occoquan service area demands. Minimum Occoquan Production can be determined from distribution system requirements for the Occoquan and maximum capacity constraints for the Potomac plant.

The FCWA Distribution System requirements module is shown in Figure 3-4.

Figure 3-4. FCWA Distribution System Requirements

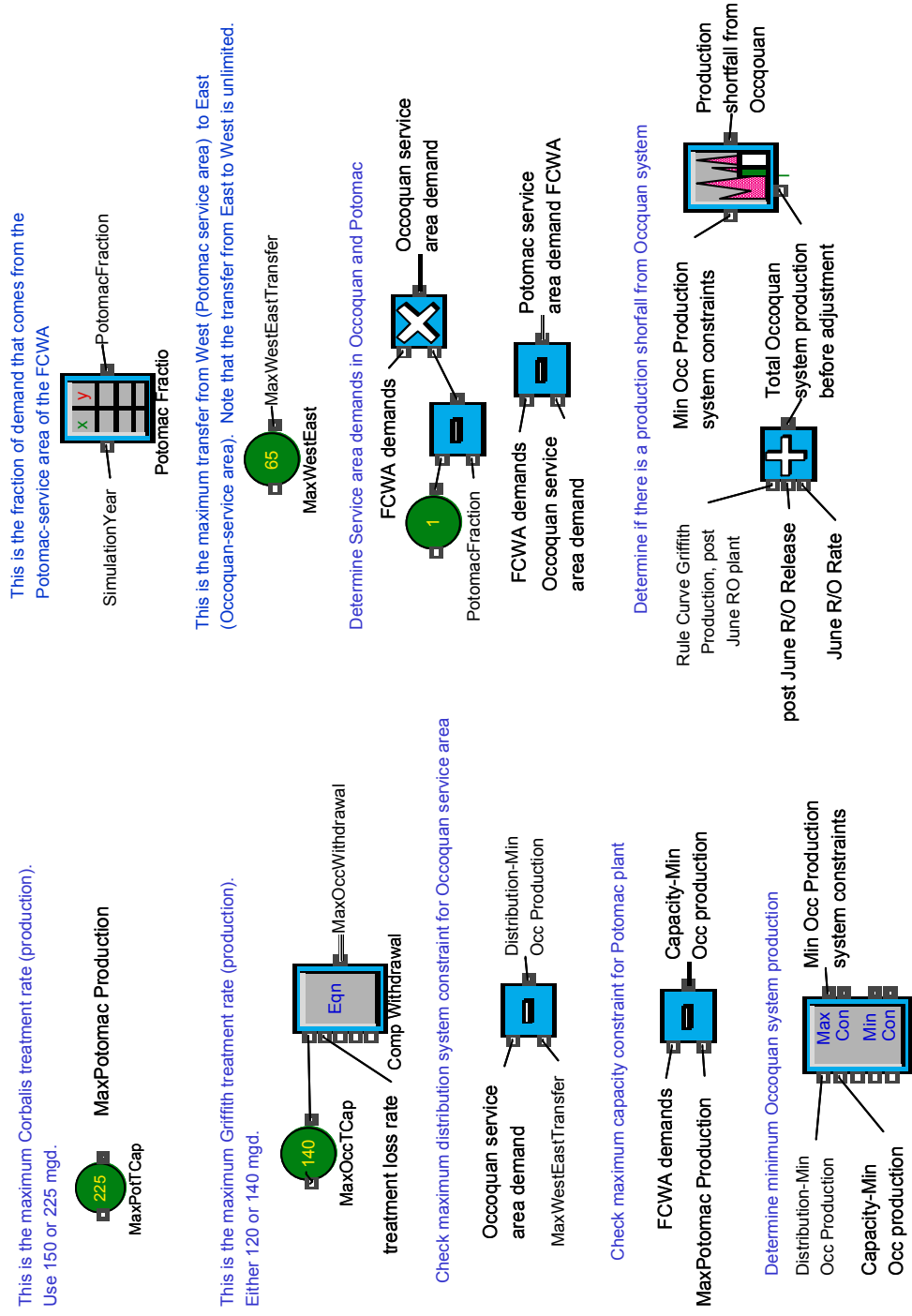

3.5 Consumptive Use

To simulate the effect of consumptive withdrawals from the system, this module of the model performs several functions. The first function is to modify the 'natural' historical flows in the Potomac to account for consumptive uses that have arisen over the past 70+ years in the watershed. The model assumes a linear relationship (i.e. interpolation) between the current year consumptive demand (129 mgd for 2003) and no (zero) consumptive demand in 1929.

The second objective of the module is to calculate future consumptive demand for the forecast period (i.e. 2004-2040). The consumptive demand can be modeled by assuming constant levels of 2020 consumptive demand or by assuming that consumptive demands increase as a function of the forecast year. Consumptive demands for the basin are further discussed in ICPRB 00-05. The variable *demswitch* can be set to either 0 or 1 to assume a constant (0) or variable demand (1) scenario.

The third function of this module is to account for new consumptive demands, such as a new power plant. The user can enter the new demand as an input.

Consumptive demand is greatest during the months of June, July and August. Therefore, the model has been programmed to estimate the consumptive demand assuming greater demand during the summer months. This logic has been established for historical, current and future consumptive demands:

*If (month > 5 & month <9) demand = sum_dem;
else demand = Sept_May_dem;*

The variable *sum_dem* represents the summer demand and *Sept_May_dem* is the variable that is used to simulate the rest of the year.

Finally, after adjusting for the season of the year, historical consumptive use, future consumptive use, and new consumptive demand are added together to simulate the total consumptive demand.

Figure 3-5 illustrates the Consumptive Demand module.

Figure 3-5. The Consumptive Demand Module

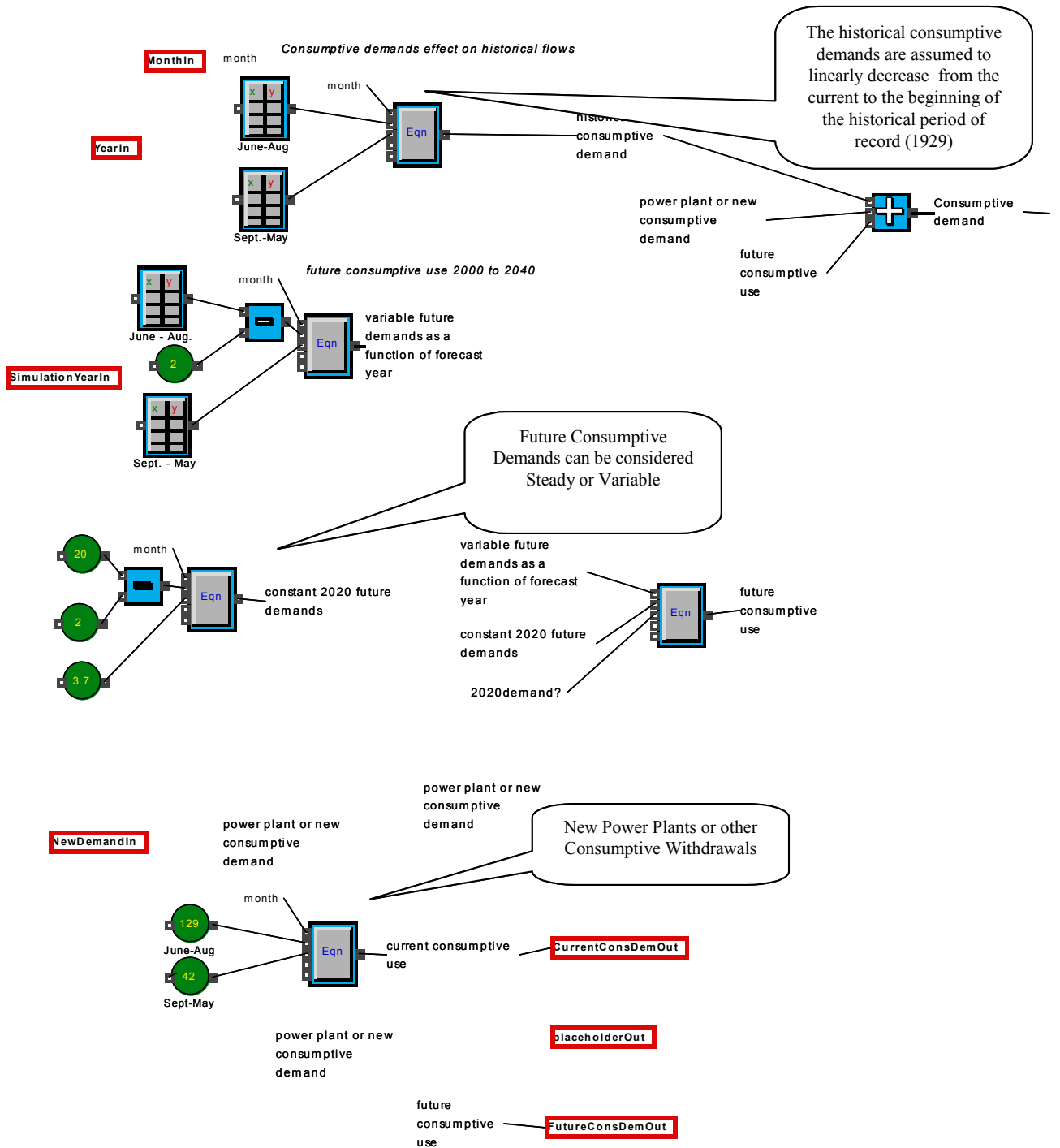

3.6 Buffering the Predicted Demand

Water balancing is designed to keep JRR and Little Seneca coordinated in a system in which storage is balanced. Reservoir storage levels are kept in balance through the introduction of an artificial buffer to the release calculations. Thus, one reservoir is never left full while the other is nearly depleted. Although the value of the artificial buffer can be positive or negative, the buffer serves as a 'penalty function' – penalizing the reservoir with more storage available and increasing the attractiveness of the other. Figure 3-6 shows the buffering demand block.

Figure 3-6. Buffering the Predicted Demand

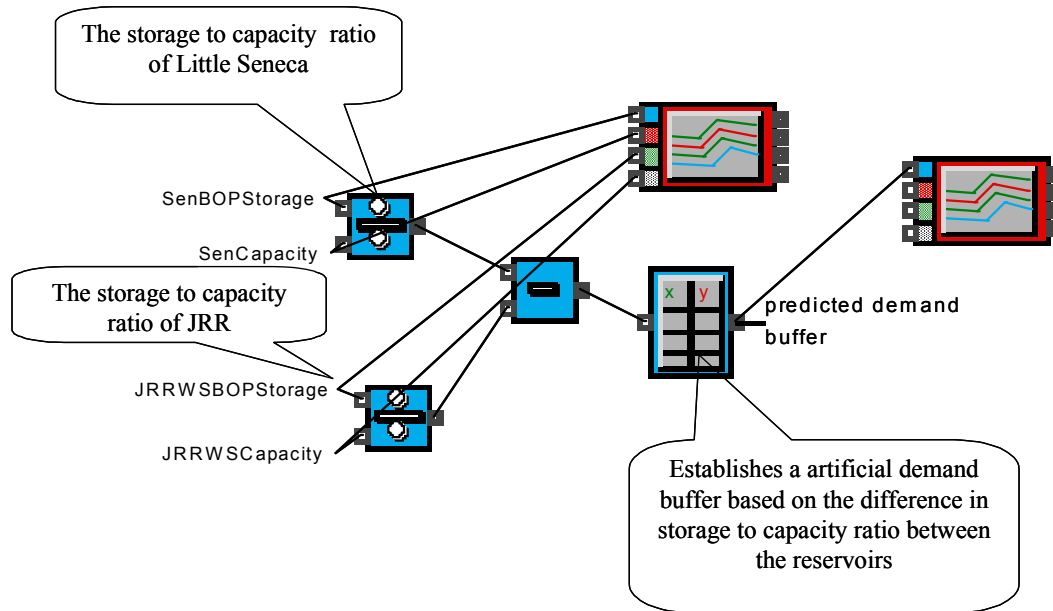

In addition, operations strive to maintain balanced storage in the Occoquan and Patuxent Reservoirs on a daily basis. This is accomplished through modest daily corrections to balance the system.

3.7 Westernport Water Supply Pipeline

A water supply withdrawal for the city of Westernport in Allegany County, Maryland is modeled to reflect this potential consumptive use. This relatively small withdrawal would occur on the North Branch of the Potomac River, downstream of Luke, approximately 150 miles upstream of the WMA.

3.8 Potomac Flow

Flow in the Middle Potomac, a primary focus of the PRRISM, is calculated as an arithmetic sum of the inflows minus the sum of the outflows. This block of the model simulates the Potomac system and calculates flow downstream of Little Falls with and without water supply releases.

The inflows:

- Seneca WWTP;
- Broad Run WRF;

- WQ Augmented Flow above Little Falls (upstream flow that includes JRR water quality release, calculated in "Potomac WQ augmented flow" and equal to natural flow plus WQ releases);
- Lagged JRR WS Release (if any, water supply release from JRR, as calculated in "Jennings Randolph Reservoir combined operations" lagged by nine days); and
- Seneca Release (if any, water supply release from Seneca, as calculated in "Seneca").

The outflows:

- Consumptive Demand (as calculated in "Consumptive Use");
- Rockville Demands (as calculated in "Water Supply Demands"); and
- Potomac Water Supply Demands (as calculated in "Water Supply Demands").

The Potomac River flow 'block' is illustrated in Figure 3-7.

Figure 3-7. The Potomac River Flow Block

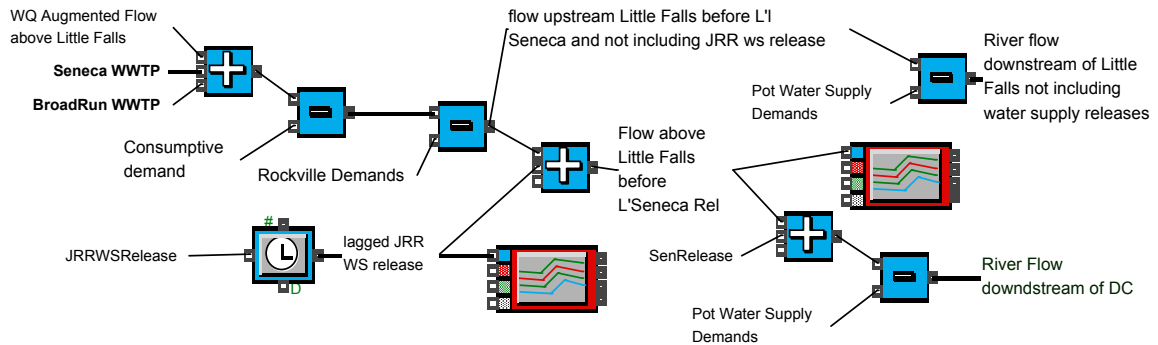

Section 4 – The Occoquan Reservoir

The Occoquan Reservoir Sub-Model routine calculates daily storage available in the Reservoir using equations to calculate 'spill' or the amount of flow discharged over the spillway, over discrete time intervals. Two algorithms are available in PRRISM to calculate storage in the Occoquan Reservoir. Although they account for flows over the spillway differently, the two methods are in agreement in predicting the minimum storage available in the reservoir.

1. Water Balance Approach: This method calculates the daily water balance at the reservoir (inflow-outflow = change in storage, subject to full pool capacity limitations). This option is represented by the variable *spill2*.
2. Spillway (Weir) Equations: This method calculates the outflow of the Occoquan Reservoir using the spillway (weir) equation. The equation is a good, but not exact, estimate of the outflow based on the spillway geometry. This option is represented by the variable *Spill1* in the variable names.

Currently the model uses the water balance approach. However, a plot is available in this section of the model to compare the results of both approaches. In this figure, the water balance approach is represented by the blue line; the spillway approach by the red line. An example of this plot is shown in Figure 4-1.

Figure 4-1. Comparison of Water Balance and Spillway Methods

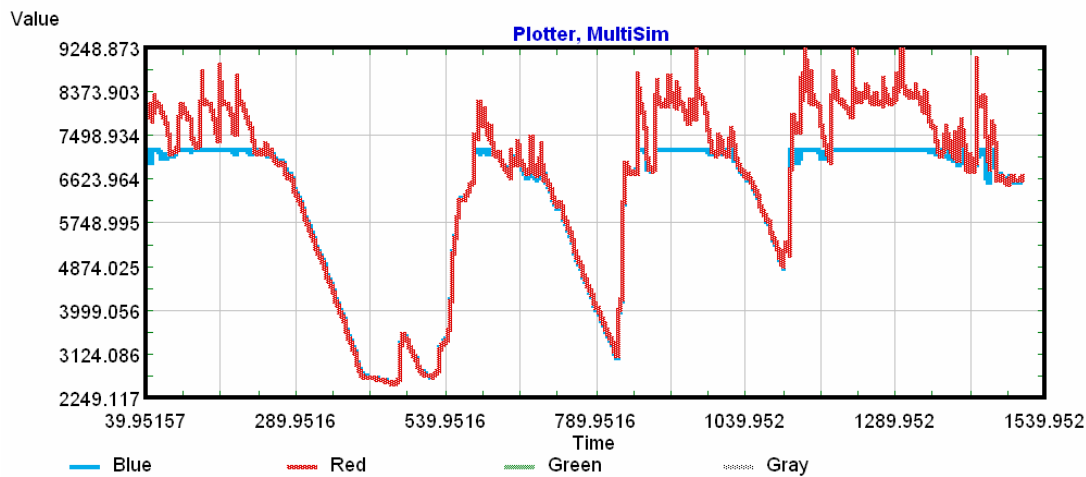

The Occoquan sub-model utilizes a 'natural' set of inflows. The natural inflow is modified to account for the effects of Lake Manassas, Dominion semiconductor, and UOSA return flows. The development of the 'natural' input series is presented in ICPRB report 98-3 (ICPRB, 1998).

The Occoquan Reservoir is subject to evaporation losses, losses owing to the accumulation of sediment deposits, and releases for hydropower operations. PRRISM accounts for these losses in the simulation, as well as the direct input of precipitation falling on the Reservoir. In addition, the effects of evaporation at Lake Manassas over time are simulated, along with variable withdrawals by the City of Manassas. Lake Manassas is further discussed in Section 4.3.

The total available storage at the beginning of the simulation period, represented by the variable BOP storage, is a user input. The current storage available in the Occoquan is based on the bathymetric survey of 2000 (OWML, B&V). The available water supply storage based on this survey is 8.1 BG.

Water Balance Approach

The storage available at each time step is calculated as the storage available at the previous time step minus evaporation and must be greater than zero. If the available storage at a given time step is greater than the desired water supply release, then the full water supply release is granted. In a similar manner, if the available storage after water supply release is greater than the desired hydropower release, the full hydropower release is granted. In each case, if the total storage is unavailable, only the available storage is released. The spillway release volume during a given time step is equal to the total available storage minus the capacity of the dam.

Spillway Weir Approach

The model calculates reservoir volume greater than the capacity of the dam by 'carrying over' volume greater than the dam capacity. This occurs when the beginning of the period storage plus the inflow is greater than the capacity of the dam. The model uses a two-hour time step to calculate reservoir storage and spill releases from the dam. The net daily values of spill are calculated as the sum of 12, two-hour blocks. The Occoquan Reservoir sub-model is shown in Figure 4-2.

Figure 4-2. The Occoquan Sub-Model

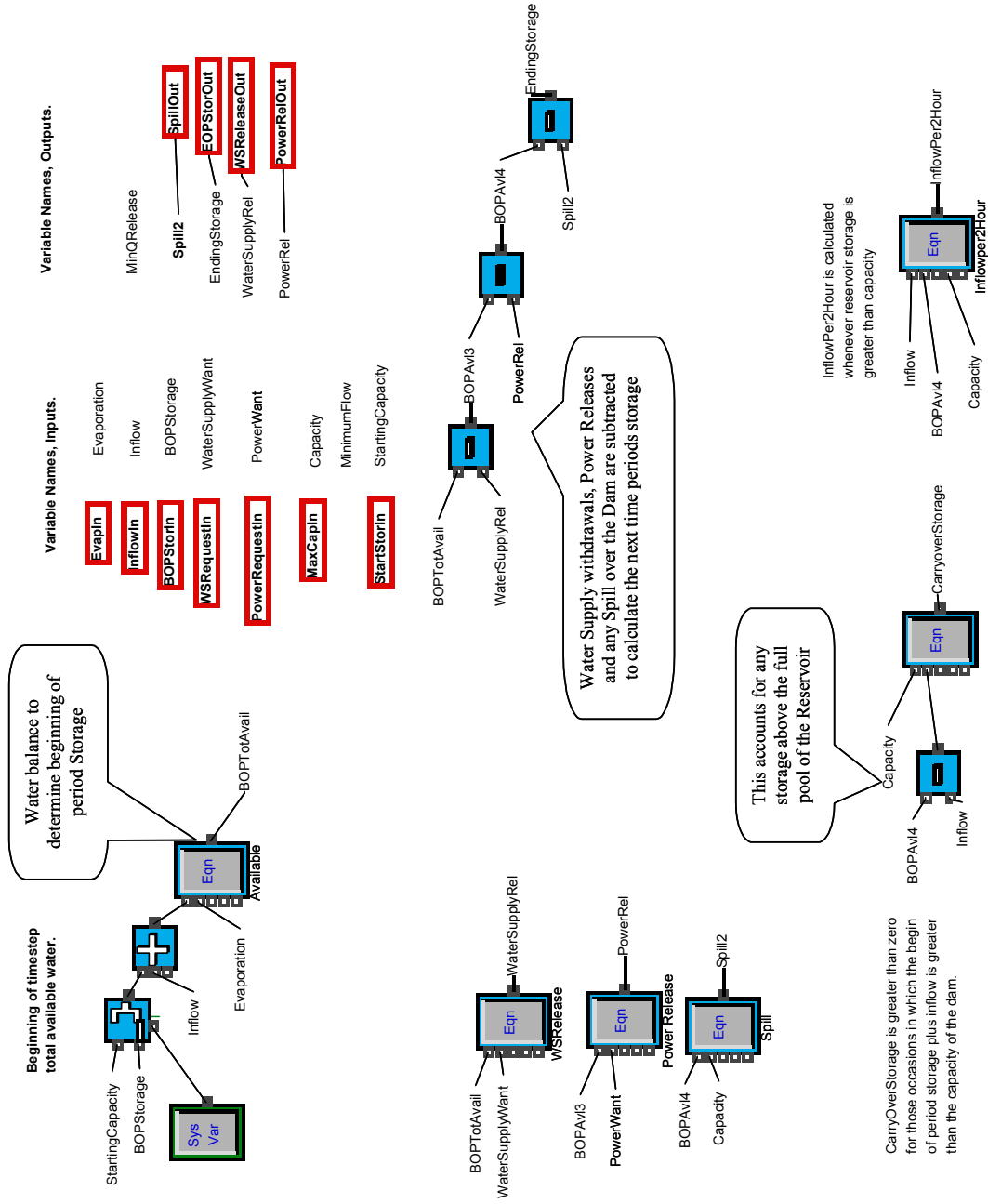

4.1 Occoquan Hydropower

Two hydro generators capable of producing electricity are located at the Occoquan High Dam impounding the reservoir. For PRRISM simulation, the amount of water released for hydropower generation is a function of the reservoir storage, day of the year, and operating rules developed at ICPRB in collaboration with FCWA. The current time period's storage, *Occoquan Storage In*, is converted to a stage. This stage is compared with decision tables to determine whether to use 0, 1 or 2 generators.

The Occoquan Hydropower generation can be simulated 'On' or 'Off'. See Section 1.10 for more information on this switch.

The Occoquan Hydropower Module is shown in Figure 4-3.

Figure 4-3. Occoquan Hydropower Module

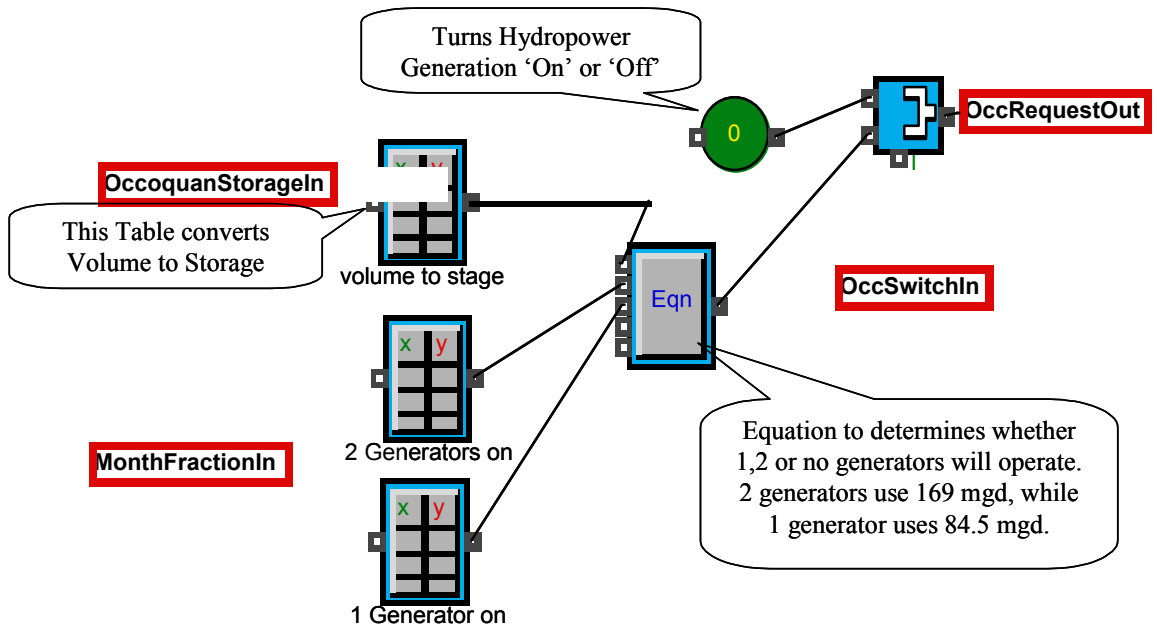

If storage is greater than "TwoGen" value, then release thru both generators. If storage is between values, release through one generator. If storage is below "OneGen" values, then make no hydropower release.

Hydropower release depends on the storage in the reservoir and the time of month, and is based on the empirical/historical operating rules developed at ICPRB in collaboration with FCWA.

4.2 Lake Manassas

Lake Manassas, a reservoir located in Prince William and Fauquier Counties, VA, and within FCWA's Occoquan Reservoir watershed, serves as a primary drinking water source for the City of Manassas, VA. A water balance and routing model is simulated for Lake Manassas because of its use as a drinking water source, and its' ability to provide 'plug flow' type releases into the Occoquan basin flow.

The storage available at each time step is calculated as the storage available at the previous time step plus inflow minus evaporation and must be greater than zero (a logical constraint). If the available storage at a given time step is greater than the desired water supply release, then the full water supply release is granted. If the total storage is unavailable, only the available storage is released. The spillway release volume during a given time step is equal to the total available storage minus the capacity of the dam. Inputs and Outputs to the Lake Manassas Sub-Model are listed in Table 4-1.

Table 4-1. Inputs and Outputs to the Lake Manassas Sub-Model

Inputs	Outputs
Evaporation	End of Period Storage
BOP Storage	Min Flow Release
Capacity	Spill
Inflow	Water Supply Release
Minimum Flow Request	
Water Supply Request	
Starting Capacity	

Water supply withdrawals by the City of Manassas with demands are modeled as a function of month and simulation year. A switch (0 or 1) provides the ability to turn on/off modeling withdrawals considering a monthly demand factor or a constant. The blocks simulating Manassas water supply withdrawals are shown in Figure 4-4.

Figure 4-4. Lake Manassas Water Supply Withdrawals

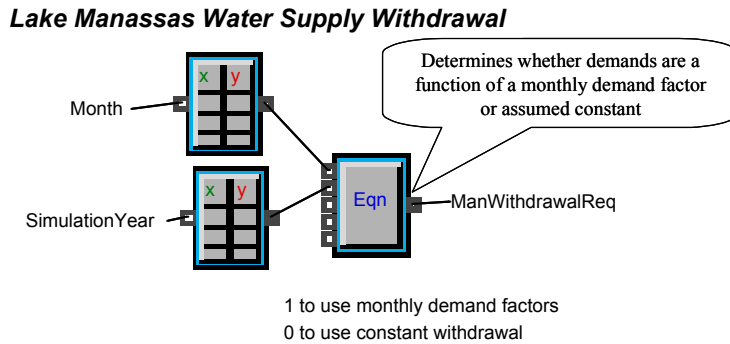

Several variables are modeled as constants. These include:

- Lake Manassas Capacity – held constant at year 2000 levels (5.8 billion gallons)
- Storage Increase from the Inflatable Dam (1.4 billion gallons)
- Natural inflow to Lake Manassas – Calculated by an area-adjustment of the Occoquan Reservoir natural inflow. Development of the Occoquan natural inflow is further discussed in ICPRB report 98-3 (ICPRB, 1998).

4.3 Occoquan Net Inflow and Evaporation

The Occoquan 'natural' inflow is a user input, with historical daily inflow estimates documented in ICPRB report 98-3 (ICPRB, 1998). Section 2.2 provides more discussion of this and other User Inputs.

The 'net' Occoquan inflow takes into account 'man-made' inflows and releases. The water balance module is shown in Figure 4-5. More simply, the inflows and outflows can be categorized to illustrate the water balance:

The Inflows:

- The 'natural' inflow into the Occoquan basin minus the Lake Manassas 'natural' inflow;
- Lake Manassas Minimum Flow Release;
- Manassas Spill Release; and
- UOSA Flow (see Section 8 for more discussion of this input).

The Outflows:

- Dominion out-of-basin transfers (see Section 4.5 for more discussion of this topic).

Figure 4-5. Net Occoquan Inflow

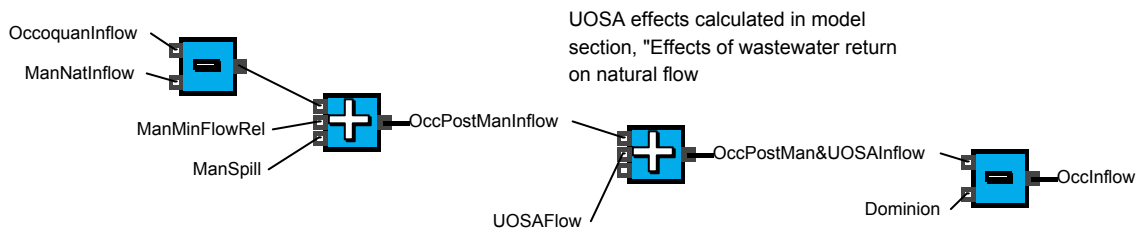

Evaporative effects are simulated for the Occoquan Reservoir. Occoquan evaporation is calculated as a function of storage and day of the month. Evaporation data utilized in this module were developed in ICPRB report 98-3. (ICPRB, 1998a). The evaporative calculation utilizes pan evaporation and precipitation data from the National Climatic Data Center for the Piedmont Research Station in Orange County, VA. Note that pan evaporation and precipitation data tables provide values for the 1st day of each month. Values for the subsequent days of each month are calculated by interpolation. Thus, the values in the table extend to 13 instead of 12 so that values during the month of December can be calculated by interpolation.

4.4 Dominion Out of Basin Transfers

The calculation of the net inflows into the Occoquan basin considers the effects of water withdrawals taken by the Dominion semiconductor plant in Manassas, VA. These withdrawals occur upstream of the Occoquan Reservoir, and are hence not available for raw water withdrawals by FCWA. Dominion withdrawals can be modeled as 1 mgd or 8 mgd, with a switch (0 or 1 respectively) available to simulate either scenario. Dominion out-of-basin transfers are shown in Figure 4-6.

Figure 4-6. Dominion Out of Basin Transfers

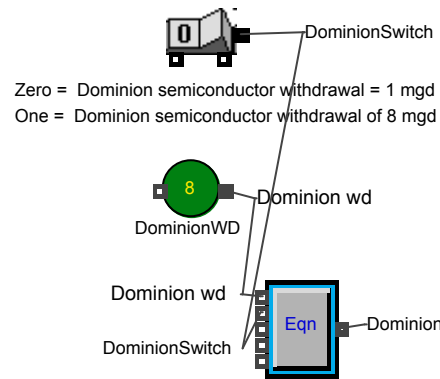

4.6 Occoquan Water Supply Withdrawals and Estuary Treatment

As part of a study to evaluate the technical feasibility of using the Occoquan estuary near the Town of Occoquan, VA, as source of municipal water supply for the WMA (CDM, 2003), ICPRB evaluated alternate operating rules to supplement the CO-OP operating rules for the WMA water supply system. The operating rules evaluated for the Occoquan Bay estuary assumed that the estuary source would be used during drought periods only. The study evaluated the feasibility of constructing and operating a 25 mgd and 50 mgd facility.

The Occoquan water supply withdrawal sub-model simulates Griffith treatment plant operating 'Rule Curves' and dictates when withdrawal shortfalls would trigger operation of an Estuary treatment plant. Withdrawal recommendations are made using three rule curves (a low, medium and high curve) developed by ICPRB in conjunction with FCWA (CDM, 2001). The Rule Curves are a function of the current water storage in the reservoir. The model simulates production losses, which are typically assumed to be around 5%.

During the estuary study, ICPRB evaluated four regional operating rules for the Occoquan estuary (CDM, 2003).

- June 1st trigger: the Occoquan Bay Reverse Osmosis (RO) treatment facility is 'turned' on June 1st of each year when the antecedent 12-month rainfall totals less than 37.6 inches. Note: the 12-month rainfall of 37.6 represents the cutoff for the driest 33 percent of years in the 73-year period that was analyzed (1930 through 2002).
- Upstream reservoir storage trigger (60 percent full): the Occoquan Bay RO treatment facility is 'turned on' when the combined storage in the Potomac River augmentation reservoirs falls below 60 percent full which roughly corresponds to the 'voluntary restriction' phase of the regional drought coordination plan.
- Low flow trigger: the Occoquan Bay RO treatment facility is 'turned on' when regional water demand is within 75 mgd of the available Potomac River streamflows.
- Hybrid rule: this rule combines the Low Flow Trigger with the June 1st trigger.

These operating rules were incorporated into an Occoquan withdrawal and estuary sub-model. The annotated sub-model is illustrated in Figure 4-7a and Figure 4-7b.

Figure 4-7a. Occoquan Withdrawal and Estuary Sub-Model

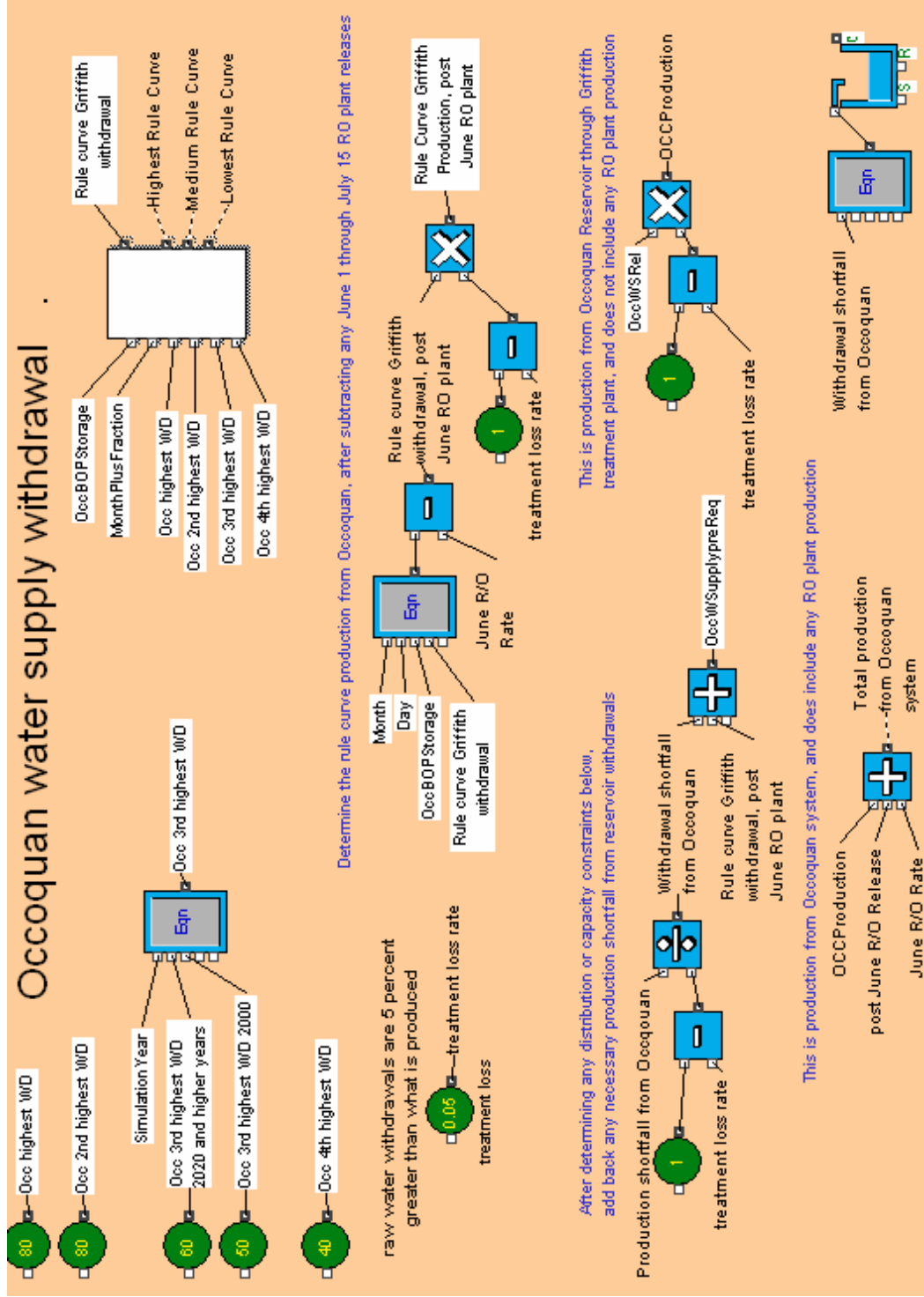
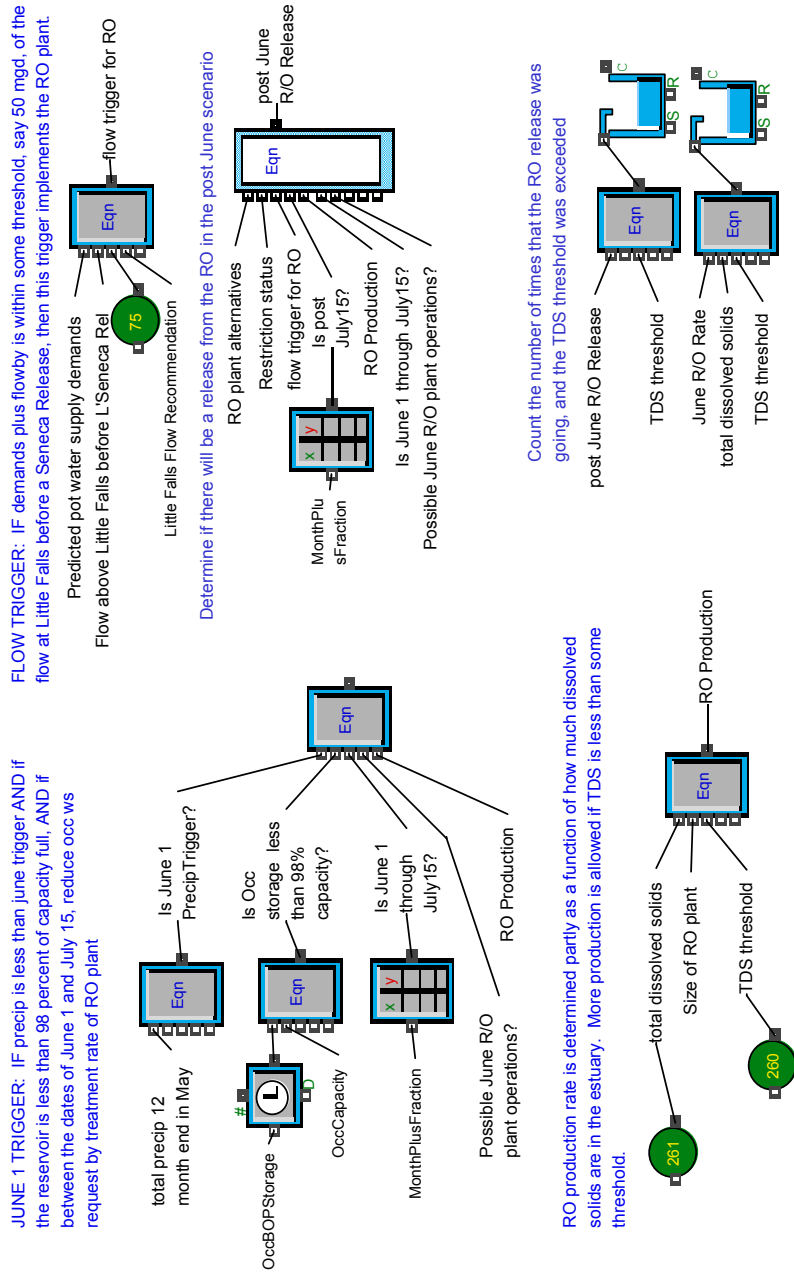

Figure 4-7b. Occoquan Withdrawal and Estuary Sub-Model



JUNE 1 TRIGGER: IF precip is less than june trigger AND if the reservoir is less than 98 percent of capacity full, AND if between the dates of June 1 and July 15, reduce occ ws request by treatment rate of RO plant

FLOW TRIGGER: IF demands plus flowby is within some threshold, say 50 mgd, of the flow at Little Falls before a Seneca Release, then this trigger implements the RO plant

RO production is determined partly as a function of how much dissolved solids are in the estuary. More production is allowed if TDS is less than some threshold.

Count the number of times that the RO release was going, and the TDS threshold was exceeded post June R/O Release

RO production rate is determined partly as a function of how much dissolved solids are in the estuary. More production is allowed if TDS is less than some threshold.

Count the number of times that the RO release was going, and the TDS threshold was exceeded post June R/O Release

Predicted pot water supply demands
Flow above Little Falls before L'Seneca Rel
75
Little Falls Flow Recommendation
Determine if there will be a release from the RO in the post June scenario
RO plant alternatives
Restriction status
flow trigger for RO
Is post July15?
RO Production
Is June 1 through July15?
Possible June R/O plant operations?

total precip 12 month end in May
Is June 1 PrecipTrigger?
OccBOPStorage
OccCapacity
Is Occ storage less than 98% capacity?
MonthPlusFraction
Is June 1 through July15?
Possible June R/O plant operations?
RO Production

total dissolved solids
261
Size of RO plant
TDS threshold
260
RO Production

post June R/O Release
Eqn
TDS threshold
June R/O Rate
total dissolved solids
TDS threshold

Section 5 - Patuxent Reservoir

The WSSC owns and operates the Triadelphia and Rocky Gorge Reservoirs in the Patuxent River Watershed to serve its Patuxent WTP. PRRISM models the Patuxent reservoirs as a single reservoir because the reservoirs are in series, in close proximity, and are operated in a coordinated combined operation in serving the Patuxent River WTP. The Patuxent sub-model employs a water balance similar to that of the Occoquan, with the primary differences being that 1) the Patuxent uses only one method of calculating 'spill' and 2) the Patuxent does not have hydropower generation.

The storage available at each time step is calculated as the storage available at the previous time step plus inflow minus evaporation and must be greater than zero (a logical constraint). If the available storage at a given time step is greater than the desired water supply release, then the full water supply release is granted. If the total storage is unavailable, only the available storage is released. The spillway release volume during a given time step is equal to the total available storage minus the capacity of the dam. Inputs and Outputs to the Patuxent Sub-Model are listed in Table 5-1.

Table 5.1 Inputs and Outputs to the Patuxent Sub-Model

Inputs	Outputs
Patuxent Evaporation	Patuxent End of Period Storage
Patuxent BOP Storage	Patuxent Min Flow Release
Patuxent Capacity	Patuxent Spill
Patuxent Inflow	Patuxent Water Supply Release
Patuxent Minimum Flow Request	
Patuxent Water Supply Request	

5.1 Patuxent Evaporation

Evaporative effects, as with the other reservoirs in PRRISM, are simulated for the Patuxent River reservoirs. Patuxent evaporation is calculated as a function of storage and day of the month. Evaporation data utilized in this module was developed in ICPRB report 98-4a. (ICPRB, 1998b). The evaporative calculation utilizes pan evaporation and precipitation data from the National Climatic Data Center in Beltsville, MD. The calculation of evaporation is illustrated in Figure 5-1. Note that pan evaporation and precipitation data tables provide values for the 1st day of each month. Values for the subsequent days of each month are calculated by interpolation. Thus, the values in the table extend to 13 instead of 12 so that values during the month of December can be calculated by interpolation.

Figure 5-1. Evaporation Calculations

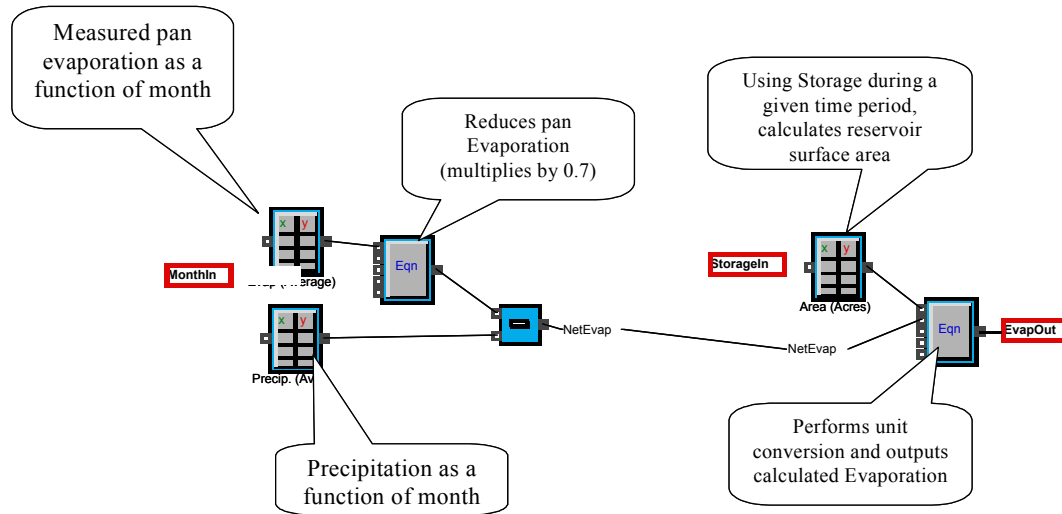

5.2 Patuxent Water Supply Demands

ICPRB, in collaboration with WSSC, has developed operating rules for water withdrawals from the Patuxent River Reservoirs that are simulated in PRRISM. Under such rules, Patuxent water withdrawals are a function of storage and day of the year. To simulate actual operations, three different requests can be made: a maximum, medium or minimum withdrawal. The inputs, shown in Figure 5-2, are a function of the Patuxent WTP capacity and associated infrastructure.

Figure 5-2. Setting Withdrawals for the Patuxent Reservoir System

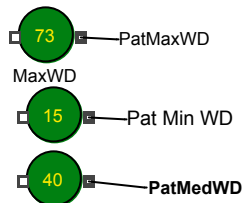

The actual withdrawal calculated for any given day considers the storage available and compares it to two different rule curves, a low and high rule curves. The rule curves are a function of the time of the year.

The following logic is used to determine the withdrawal requested from Patuxent:

- If storage is less than 1000 acres, make no release.
- If storage is greater than 1000 acres and less than the Lower Rule Curve, release the minimum withdrawal.
- If storage is greater than the Low Rule Curve and less than the High Rule Curve, release the medium withdrawal.
- If storage is greater than the High Rule Curve, release the maximum withdrawal.

Section 6 - Little Seneca

The Little Seneca Reservoir provides a valuable operational flexibility to the Water Supply system because of the relatively short travel time for releases to reach the WMA intakes (approximately one day). The Little Seneca sub-model employs a water balance similar to that of the Patuxent Reservoir, except that no water withdrawals are made at Seneca.

The storage available at each time step is calculated as the storage available at the previous time step plus inflow minus evaporation and must be greater than zero (a logical constraint). If the available storage at a given time step is greater than the desired water supply release, then the full water supply release is granted. If the total storage is unavailable, only the available storage is released. The spillway release volume during a given time step is equal to the total available storage minus the capacity of the dam.

6.1 Little Seneca Water Supply Request

The need for Little Seneca water supply releases is determined from the total of Potomac water supply demands and flow-by targets minus the flow above Little Falls before any Little Seneca release. As discussed in Section 1, a safety factor is used when releases are made from Little Seneca. The summation of the safety factor and the difference between the Potomac Water Supply demands and flow-by targets minus the flow above Little Falls before any Little Seneca Release is equal to the calculated release for Little Seneca.

Figure 6-1. Little Seneca Water Supply Request Block

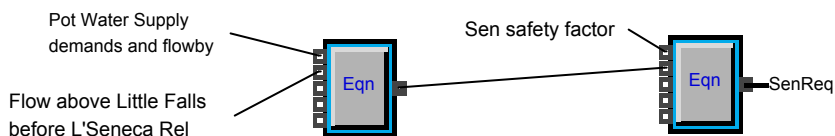

6.2 Load Shifting

The same algorithm used to calculate the Little Seneca water supply request is also used to create a 'flag' that Little Seneca releases are imminent. The predicted shortage before Little Seneca releases is used to 'flag' load shifting, the transfer of water production to the Occoquan and Patuxent facilities.

Section 7 - The Upstream Reservoirs (Jennings Randolph and Savage River)

The COE operates both the Savage River Reservoir and the Jennings Randolph Reservoir upstream of Luke, MD. These reservoirs are operated together to improve water quality in the North Branch of the Potomac River. Although only JRR contains volume appropriated to the WMA water supply, the combined Corps operations are modeled in PRRISM to reflect the actual system conditions and to take advantage of the synergistic effects of joint operation (Hagen et al., 2004).

7.1 Water Supply Releases

The objective of this series of blocks for the upstream reservoirs is to calculate the volume needed to be released from JRR (note: Subsequent algorithms keep both reservoirs, JRR and Seneca, balanced, see "Buffering the Predicted Demand"). A resulting deficit would require a release from JRR. Thus, the Potomac River flow at Little Falls in nine-days time must be estimated.

7.2 Estimating Potomac flow at Little Falls in nine days time

For any given discrete time interval, historical stream flow records are used to develop likely estimates of the Potomac river flow at Little Falls in nine days. Flow forecasting is a critical part of the simulation as any potential water supply releases from JRR reach the WMA in nine days. Insufficient resources in the WMA as a result of overestimating flow at Little Falls nine days prior or underestimating the effect of upstream releases must be made up from releases from Little Seneca.

7.3 Potomac WQ augmented flow

Potomac water quality augmented flow is a variable simulated in the model to account for COE releases from JRR and SRR in consideration of water quality conditions near Luke, MD. By using this value as a decision variable, the benefits of the water quality releases can be accurately accounted for in considering the need for water supply augmentation releases.

7.4 Combined Operations of SRR and JRR

The Corps operates the Savage River and JRR according to the COE *Master Manual for Reservoir Regulation North Branch Potomac River Basin, Appendix A: Jennings Randolph Lake, and Appendix B: Savage River Dam* (Master Manual) (COE, 1981) and their professional judgment. ICPRB developed algorithms to reflect the logic of the *Master Manual* and the likely decisions of the COE operations professionals. These algorithms were developed through a series of interviews with COE professionals by iteratively simulating various scenarios (Hagen, 2004 personal). Several operational strategies are programmed into PRRISM, allowing the user to evaluate and compare them. **More extensive documentation of the North Branch operations as modeled by ICPRB is provided in Appendix B, as well as calibration results showing modeled versus historical flows and reservoir storage.**

7.5 COE Water Quality Releases

SRR and JRR are operated to maximize the minimum summertime flow given various constraints. To do this, the COE estimates expected inflow and available volume to determine release rates. Historical streamflow records are used to classify the current inflow in terms of a historical percentile. Forecasted flows are assumed to follow the trend established by the current percentile. The COE uses a 30-to 90-day time horizon for forecasting future flows.

The expected storage available for water quality releases is calculated as the linear difference between the storage available at the end of the forecast period and that of an operating rule curve. The process used by COE is summarized in Figure 7-1.

Figure 7-1. Operating Process for North Branch Water Quality Releases

- | |
|---|
| <ol style="list-style-type: none">1. Calculate current percentile based on analysis of historical flows2. Use percentile to 'forecast' inflows over planning horizon period (30-90 days)3. Calculate available storage for release based on Rule Curves4. Select Rule Curve for SRR (A,B,C,or D) and JRR (A, B, or C)5. Divide by the number of days remaining to the end of the forecast period. The resulting daily flow rate is the water quality release. |
|---|

The graphical operating rule curves for JRR and SRR are presented in the COE *Master Manual* (COE, 1981). The COE rule curves are more fully discussed in Appendix B (ICPRB, 2003).

The operational strategy employed by COE during a drought situation is reflected in the 'status quo' operation. These 'status quo' operations were utilized in the droughts of 1999 and 2002, and are closely simulated in PRRISM. ICPRB has developed alternate operational strategies to compare with the 'status quo' to determine their benefits to the water suppliers of the WMA. The alternative operational strategies include:

- June 1 deferred drawdown
- Sept 1 deferred drawdown

The inflow during each time step is compared with historical flows and assigned a percentile. Flow percentiles vary with the season of the year. The assignment of percentile inflows is documented in the JRRPercentileInflow.xls spreadsheet file that accompanies PRRISM. The North Branch inflow calculations are illustrated in Figure 7-2.

Figure 7-2. North Branch Inflow Calculations

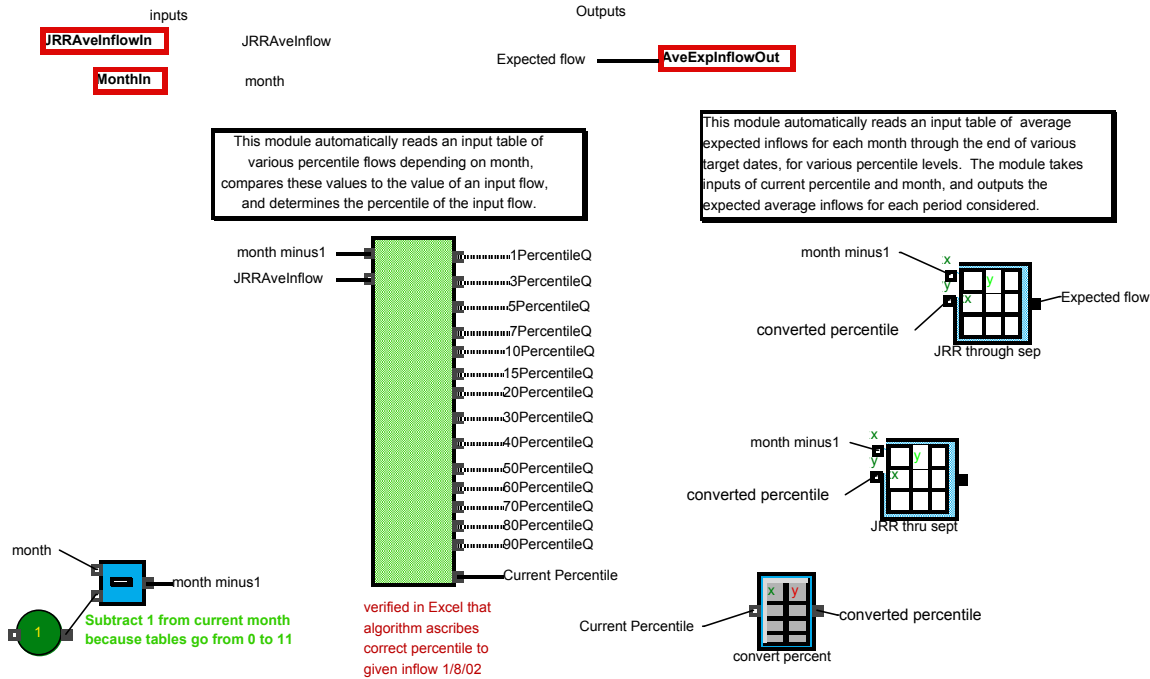

7.6 Integrating Water Quality Release Operations into Water Supply Simulation

As mentioned, the COE operates SRR and JRR in consideration of water quality impacts at Luke, MD, just downstream of the confluence of the Savage River and the Potomac River. The COE therefore, makes water quality releases from both SRR and JRR to maintain a level of in-stream flows near Luke. In-stream flows are maintained at Luke, the location of a large industrial water user and discharger to the Potomac River, for water quality purposes.

The PRRISM method for calculating this can be illustrated by breaking down the following sequence of steps.

Step #1 – Calculate Potential shortage in flow at Little Falls

The expected demands at Little Falls in nine-days time (*9-day hence deficit*) is calculated as the sum of:

- Estimated nine-day Potomac water supply demands;
- Little Falls flow-by; and
- a demand buffer factor.

The expected demands are compared with the predicted Little Falls flow, computed as:

- Little falls flow in nine days time with North Branch WQ releases.

The comparison of the expected demands and the predicted Little Falls flow leads to a calculation of the nine-day hence deficit. The calculated nine-day hence deficit is an important parameter that serves to trigger potential water supply releases.

The combined operation of JRR and SRR for water quality improvement in the North Branch of the Potomac is modeled in PRRISM. Modeling the water quality and water supply operation jointly allows for the synergistic effects of releases to be simulated and accounted for. Hence, the combined operations water supply and water quality operations of SRR and JRR are modeled in PRRISM to simulate actual operations of the system. Pre-cursor models to PRRISM made simplifying assumptions about the joint water quality operations of SRR and JRR. Integrating water quality and water supply operation in PRRISM to replicate actual operations was a significant accomplishment by ICPRB's CO-OP section.

Step #1a - Little Falls Q in 9 days time with North branch WQ releases

To calculate the *Little Falls Q in 9 days time with North branch WQ releases*, a 'preliminary' estimate of the potential shortage in flow at Little falls is calculated. During this first step, the water quality releases (from JRR and SRR) are modeled as variables. Variables are used in this step to avoid potential problems with circular logic in simulation order. A preliminary release is calculated, since the ultimate release from JRR and SRR is a function of whether water supply releases are made. When water supply releases are made, the COE typically cuts back its JRR and SRR releases to the minimum or 120 cfs (77 mgd).

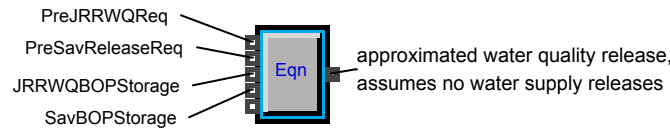

Next, an estimate of the target needed at Luke attributable to water supply is calculated using the following logic:

```

if (deficit > 0) and if lagtarget = 0)
target = max(lukeflow + deficit, lukeflow + firstday);
else
target = max(lukeflow + deficit, lagtarget - secondday);}
else
target = 0;

```

where

lagtarget = lagged water supply Luke flow target
target = release to meet Luke target from Water Supply Volume
lukeflow = flow at Luke during current time step (cfs)
deficit = 9-day hence deficit
firstday = JRR release on the first day of release
secondday = JRR release on the second day of release

Thus, if a nine-day hence deficit is calculated in Step #1, this logic establishes the target required to meet the Luke target attributable to water supply. The preliminary release becomes the water quality release from JRR and SRR. If water supply releases are made, then the COE would cut back from its preliminary release level, instead of reverting back to the minimum levels. If no deficit exists, the water supply release requested (target) is set to zero. In this situation, water quality releases alone will be sufficient to meet Luke targets without augmentation from water supply volume. Note that the water supply deficit is calculated as a positive number (e.g. deficit > 0).

Finally, the calculated release from water supply at Luke (WS Luke Target) is lagged by one day.

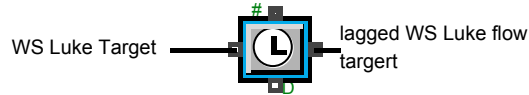

Analysis of hydrologic data by ICPRB, has indicated that releases must travel as a 'wave' to reach the WMA in nine days. While ICPRB estimates wave travel at 9 days, particle travel is estimated at a considerably longer 20 to 30 days (Trombley, 1982). To demonstrate wave-like characteristics, releases of 100 mgd or more are required. In particular, the first day's release is suggested to be at least 200 mgd to behave like a wave (ICPRB, 2004).

Step #2 – Adjust Water Supply Requests and Water Quality Requests depending on whether water supply release has been requested

This series of blocks serve as an accounting mechanism between the water supply requests and the water quality requests to reflect drought operation by the COE. The process assumes that the COE will utilize water supply releases toward meeting water quality objectives at Luke, thereby effectively reducing the water quality releases to the practical minimum of 120 cfs. This operational strategy was employed by the COE during the drought of 1999. The *amount to debit from water supply storage*, prior to any Savage match, is established as the difference between the water supply Luke Target (*WS Luke Target*), as calculated in Step #1, minus the Luke minimum flow objective (*LukeMinQ*) or is set to zero (if the calculated difference is less than zero).

Step 3 - Determine Release from JRR and SRR

Next, an estimate of the water supply release request from JRR is modified to account for any matching release from SRR. The *Savage WS Match*, a percentage match in decimal form, is multiplied by the *Pre WS Savage Request* and the resultant subtracted from the *amount of debit from WS storage, pre Sav match* to yield the *WS Release request from JRR*.

Step 4 - Determine Water Supply Request from SRR and JRR

During a water supply release, the COE releases the legal minimum (*SavLegal MinRel*), currently 20 cfs, from SRR, plus 20% of the difference between the Luke WS target and 120 cfs (*Pre WS Savage Request*). This release is termed *WS Savage Request*. Thus, if a 9-day hence deficit exists (>0), then the SRR release request (*SavReleaseReq*) is set equal to the *WS Savage Request*. If no deficit occurs, the SRR releases are set equal to the Pre-Savage Water Supply Release (*Pre Sav WS Release*). In a similar manner, if the 9-day hence deficit exists (>0), JRR WQ releases are set equal to the minimum. If not, the JRR releases revert to the water quality release calculated without a water supply request (*prewsreq*).

The following blocks contain the algorithms that guide the simulation in determining which releases to make, either the 'regular' water quality or the water supply 'mode':



7.7 Combined Operations

Releases from the SRR are often used to complement water quality operations of JRR. The releases are beneficial to water quality at Luke and benefit local industry. Further information on the SRR operations is discussed in the *Master Manual for Reservoir Regulation North Branch Potomac River Basin* (COE, 1999).

7.8 Savage River Reservoir Operations

The SRR operations module guides the simulation of releases from the SRR. The structure of this module is similar to that of the other reservoirs, in particular Little Seneca, Occoquan and Patuxent. The primary difference in the structure of the logic between the JRR and SRR blocks is that JRR, unlike the other reservoirs, has two different 'logic' tracks. However, because there is no WMA water supply storage associated with SRR, this module is very simple in comparison with the other reservoirs of the system. Specifically, JRR operations follow either 'water quality', the 'regular' mode during which all releases are made for water quality purposes only or 'water supply', during those periods when water supply releases occur. SRR, by contrast, releases only water supply to Westernport and the water quality releases requested by the COE.

The total available storage at the beginning of time period is calculated as the sum of inflow during the time step and the beginning of period storage. This calculation is represented in Figure 7-3.

Figure 7-3. Determining Available Storage

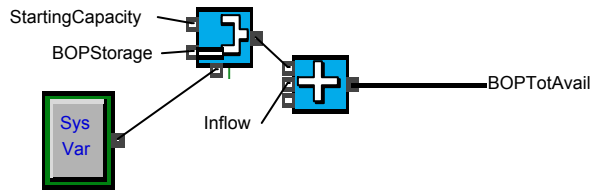

where:

- Starting Capacity = User input for Capacity at Beginning of Simulation(BG)
- BOP Storage = Beginning of Period Storage available in the Reservoir
- Inflow = Flow volume received in the Reservoir during the time interval
- BOPTotAvail = Beginning of Period Total Available Storage

As with other blocks in PRRISM, a starting capacity for the beginning of the simulation period is provided by the user. The effects of sedimentation over time will decrease the capacity available in the Reservoir. For additional information on the sedimentation module, see Section 8.

Figure 7-4 illustrates the series of blocks that guide the SRR operation by allowing for water supply delivery to Westernport, MD, and Water Quality Release requested by the COE. If the total available storage at the beginning of the time step in SRR is greater than the water supply request of Westernport, then the requested water supply release is made, and the difference subtracted from the beginning of period total available storage. The remaining volume (*WqTotAvail*) is made available to the water quality release/spill. Finally, the end of period storage is calculated by subtracting the water quality release from *WQTotAvail*.

Figure 7-4. SRR Operations Module

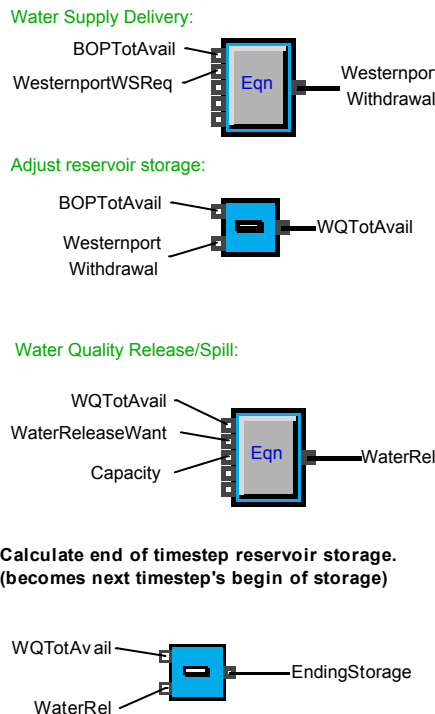

7.9 Time Step Bookkeeping and Display

This manual refers to numerous variables referencing the beginning of period and end of period during a simulation time step. There are several blocks in PRRISM designed to reset the end of period variable to the beginning of period variable after the calculation is met and before the beginning of the next time step.

Figure 7-5 illustrates the re-establishment of the variables for the JRR operations. The JRR bookkeeping is slightly more complicated than others because water quality and water supply volume is tracked separately. The other reservoir bookkeeping and display modules follow in a similar pattern.

Figure 7-5. JRR Storage Variables

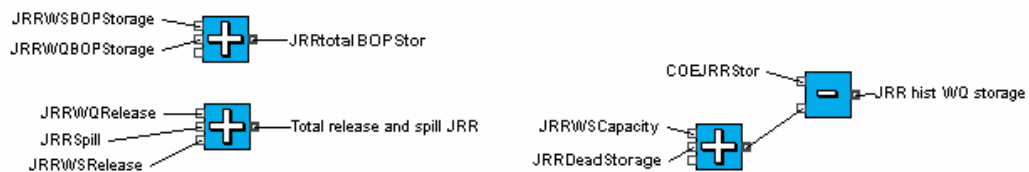

Section 8 – Sedimentation and Wastewater Return Flows

8.1 Sedimentation

The effect of the accumulation of sediment over time is simulated for all of the Reservoirs in the system. The latest available bathymetric survey's are used determine sedimentation rates by comparing the current and original estimates of storage volume. ICPRB reports 98-3, 98-4a, 98-5 and 99-3 document calculations of reservoir sedimentation. The sedimentation blocks are shown in Figure 8-1.

Figure 8-1. Reservoir Sedimentation Calculations

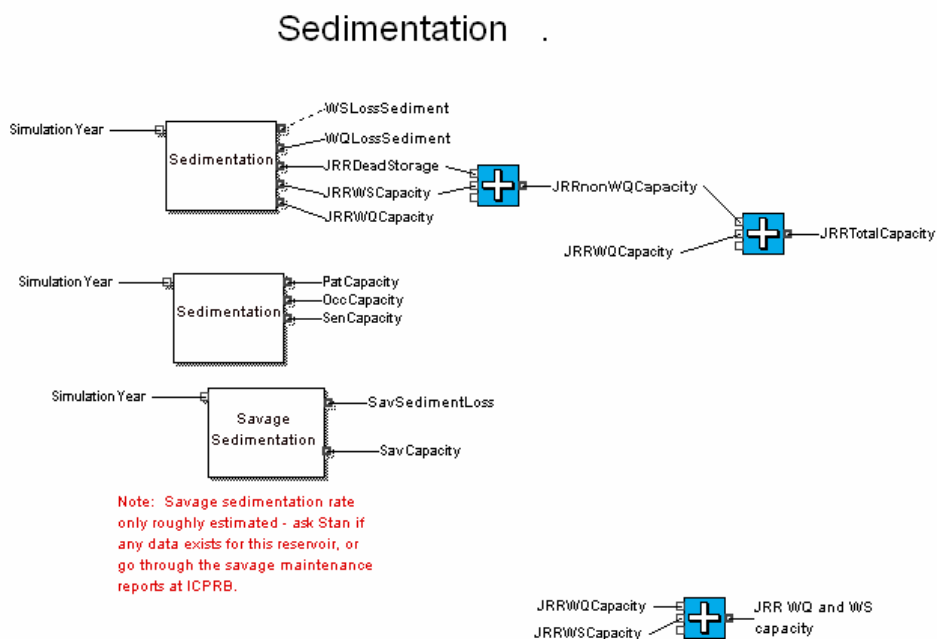

8.2 Wastewater Return Flows

Several major wastewater treatment plants serving the WMA discharge into the riverine system upstream of the water supply intakes. This treated water is recycled in that it has been generated from areas serviced by WMA water suppliers. Wastewater return flows include:

- Upper Occoquan Sewage Authority (UOSA) WRF
- Seneca WWTP, and
- Loudoun County Sanitation Authority (LCSA) Broad Run WRF

The input tables for wastewater return flows in PRRISM are shown in Figure 8-2.

Figure 8-2. Wastewater Returns Inputs

Upstream wastewater returns- effects on natural flows

UOSA flow modified by monthly production factors

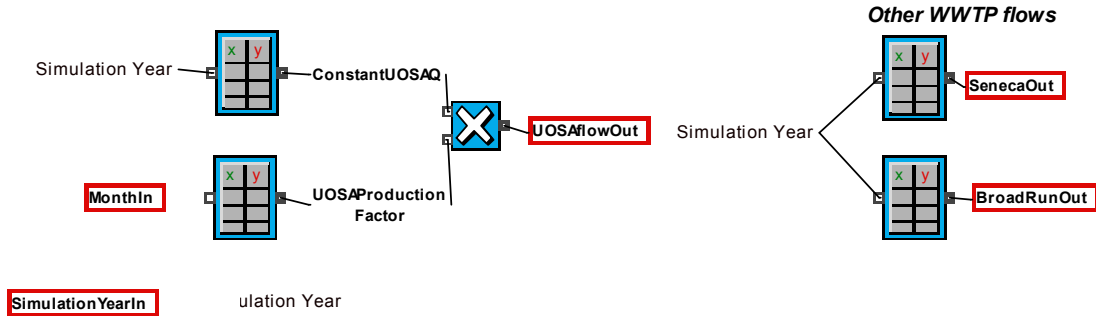

The increases in treated wastewater return flow are incorporated into PRRISM as a function of forecast year. In addition, the UOSA flows monthly flows are further disaggregated by monthly production factors, which reach a peak in the winter months.

The projected average annual return flows are listed in Tables 8.1 through 8.3, showing both current (2004) estimates and estimates used in prior demand studies (ICPRB00-6).

Table 8.1a Projected WWTP return flow for Broad Run, estimated in 2004

Year	Total LCSA Flow, average annual, MGD	LCSA Flow at Broad Run WRF, MGD	Fairfax Flow at Broad Run, MGD	Total Projected WWTP return flow for Broad Run, MGD
2015	18	4.2	1	5.2
2020	20.6	6.8	1	7.8
2025	22.4	8.6	1	9.6
2030	23.8	10	1	11

Note: Data provided by Tim Coughlin and Tom Broderick, 9/7/2004, as based upon the information from the "BPSA Wastewater Flow Management Programs - 2003 Annual Report" that was produced by MWCOG that showed total LCSA flow. Broad Run return flow is based upon LCSA maximizing its 13.8 allocation at Blue Plains and assuming 1 mgd of treated flow originating from Fairfax County.

Table 8.1b Projected WWTP return flow for Broad Run, estimated in 1999

Year	Flow, MGD
2000	0
2015	0
2020	10.7
2030	17.4
2040	23.2
2050	28.9

Note: Data provided by consultant to LCSA, as cited in ICPRB 00-6.

Table 8.2a Projected WWTP return flow for Seneca WWTP, estimated in 2004

Year	Flow, MGD
2005	17.1
2010	18.8
2015	20.6
2020	22
2025	22.5
2050	27

Note: Data provided by Craig Fricke, 9/2/2004. Note that WSSC does not routinely do projections beyond the date of the official demographic projections, but estimated 26-28 mgd for 2050 as a rough estimate.

Table 8.2b Projected WWTP return flow for Seneca WWTP, estimated in 1999

Year	Flow, MGD
2000	6
2002	6
2003	17
2020	22.4
2050	26

Note: Data provided by Karen Wright.

Table 8.3a Projected WWTP return flow for UOSA WWTP, estimated in 2004

Year	MGD	Year	MGD
2005	29	2028	49.7
2006	29.9	2029	50.6
2007	30.8	2030	51.5
2008	31.7	2031	52.4
2009	32.6	2032	53.3
2010	33.5	2033	54.2
2011	34.4	2034	55.1
2012	35.3	2035	56
2013	36.2	2036	56.9
2014	37.1	2037	57.8
2015	38	2038	58.7
2016	38.9	2039	59.6
2017	39.8	2040	60.5
2018	40.7	2041	61.4
2019	41.6	2042	62.3
2020	42.5	2043	63.2
2021	43.4	2044	64.1
2022	44.3	2045	65
2023	45.2	2046	65.9
2024	46.1	2047	66.8
2025	47	2048	67.7
2026	47.9	2049	68.6
2027	48.8	2050	69.5

Note: Data provided to ICPRB by Traci Kammer Goldberg, as compiled by John C. (Jack) Sellman, Upper Occoquan Sewage Authority, Director, Treatment Process Division, September 2004.

Table 8.3b Projected WWTP return flow for UOSA WWTP, estimated in 1998

2005	30
------	----

2010	34
2020	42
2030	51
2040	59
2050	66.8

Note: Data provided by FCWA and referenced in ICPRB 00-6.

Production factors were developed to convert average annual values to monthly values. The monthly multiplier is applied to the annual projected rate to calculate how production varies throughout the year. Typically the numbers range from 0.8 to 1.2 for these treatment plants. It is important to capture the variation in production since water supply releases from the Jennings Randolph and Little Seneca reservoirs since would occur during the times that releases from the treatment plants are at their lowest. Lower estimates of wastewater return flow are thus a conservative assumption in the PRRISM model, because lower return flows from these treatment plants cause higher releases rates from the reservoirs. To calculate monthly production factors, the monthly average is divided by the annual average for each month. Tables 8-4 through 8-6 show the production factors calculated for Broad Run, Seneca, and UOSA WWTPs.

Table 8.5 Production factor used to estimate monthly return flow, estimated for Broad Run WWTP

Month	Monthly factor (minimum of 2001, 2002, and 2003 factors)
January	0.93
February	0.93
March	0.97
April	0.96
May	0.98
June	0.97
July	0.92
August	0.89
September	0.99
October	0.95
November	0.98
December	1.02

Note: Data request to Tim Coughlin and as provided by Sherrie M. Leanord, Engineering Programs Assistant, LCSA in November of 2004.

Table 8.5 Production factor used to estimate monthly return flow, estimated for Seneca WWTP

Month	Monthly factor (minimum of 2002, 2003, and 2004 factors)
January	0.94
February	0.96
March	1.02
April	0.99
May	0.84
June	1.00
July	0.96
August	0.92
September	0.95

October	0.93
November	0.97
December	0.99

Note: Data request to Craig Fricke, as compiled by Shari Djourshari of WSSC in January of 2005.

Table 8.6 Production factor used to estimate monthly return flow, estimated for UOSA in 2004

Month	Monthly factor	
	Estimated in 2004	Estimated in 1998
January	1.08	1.15
February	1	1.14
March	1.14	1.23
April	1.01	1.01
May	1.03	0.96
June	0.98	0.93
July	0.92	0.91
August	0.94	0.93
September	0.93	0.88
October	0.95	0.89
November	0.96	1.01
December	1.04	0.97

Note: Data provided to ICPRB by Traci Kammer Goldberg, as compiled by John C. (Jack) Sellman, Upper Occoquan Sewage Authority, Director, Treatment Process Division, September 2004.

Section 9 - Running the Model and Model Results

9.1 Running the Model

The PRRISM model requires the spreadsheet PRRISM.xls to be used to receive output from the model. With this file open, the model can be run from within the EXTEND environment. The selections for running the model can be found under the 'Run Simulation' bar at the top of the screen. The Run options include Running the Simulation, Simulation Setup, Stopping, and Debugging. EXTEND can show animation while running model to plot user-established graphs as the simulation occurs. The Run Simulation - Simulation Set-up dialog box is shown in Figure 9-1. The model is set-up with a unit of days, and the user can enter the time over which to simulate. The initial time step must begin at time zero (1929). This corresponds to the beginning of the available flow records. The ending value must be within the planning horizon constraints for which simulated parameters have been established. The model is currently configured to model through 2050.

Figure 9-1. The Simulation Setup

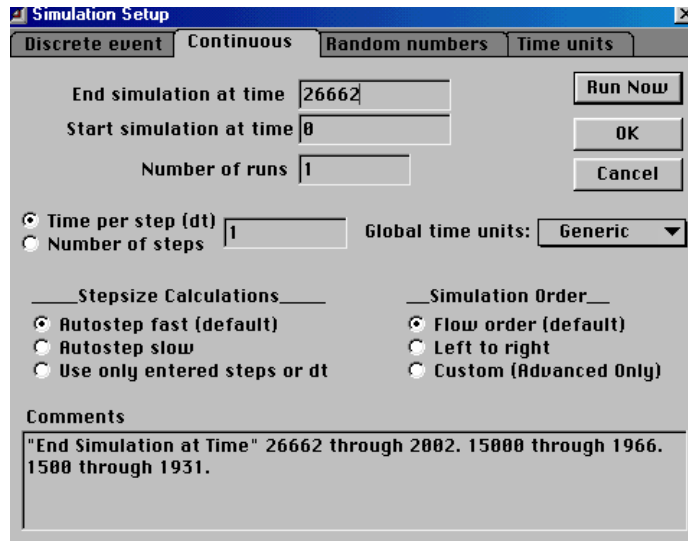

9.2 Results within PRRISM

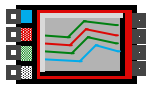

The graph block is used to plot up to four input variables over time. Plots can be viewed during a simulation run for 'real time' analysis of specific variables. While the graph block is a powerful tool for observing the value of any variables, it does not allow graphs to be formatted by the user. Thus, in order to summarize the Model's output, the read-out block is used to designate specific variables to be sent to an external spreadsheet. An example of the Read-out block is shown in Figure 9-2.

Figure 9-2. An Example of the Read-Out Block

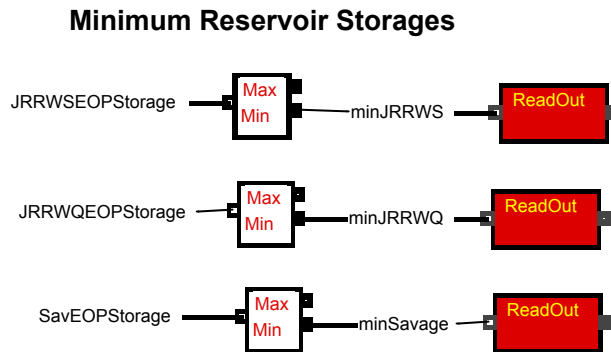

An interface in the Notebook has been established to summarize key parameters from the North Branch Water Quality module. The results include: average flow at Luke, MD; monthly flow at Luke for months during specific droughts, minimum water supply and water quality storage and color-standard water quality results. Figure 9-3 shows the table used in the Notebook to summarize the North Branch operations.

Figure 9-3. North Branch Results in the Model

North Branch - Results

Average flow at Luke mgd (1930 - 1999)

January	
February	
March	
April	
May	
June	
July	
August	
September	
October	
November	
December	

Monthly flow at Luke (includes water supply releases)

	1930	1966	1999
May			
June			
July			
Aug.			
Sept.			
Oct.			NA

Minimum water supply storage

Combined Jennings
Randolph/ Little
Seneca

Jennings Randolph

Little Seneca

Patuxent

Ocoquan

Minimum water quality storage

Jennings Randolph

Savage

Number of times unable to meet monthly average color standard, (1985-1999) (15 possible each month w/ 450 ptCo effluent)

January	1
February	0
March	0
April	0
May	0
June	3
July	7
August	6
September	2
October	2
November	4
December	1

Total

Lake Stability Levels May through June 15

what is appropriate level ?	Jennings	Randolph	Savage
Percentage of DAYS that reservoir elevation is outside of fish range			
Percentage of YEARS that reservoir elevation is outside of fish range			

9.3 Output to Excel

Selected model run results from the read-out block are sent to the PRRISM.xls spreadsheet. The key results for the system of Reservoirs are presented in tabular form. They include:

- Minimum storage;
- Minimum percent full; and
- The simulation date for when each occurred.

The spreadsheet output is shown in Figure 9-4.

Figure 9-4. The PRRISM.xls spreadsheet

Potomac Reservoir and River Simulation Model (PRRISM)

Interstate Commission on the Potomac River Basin, Section for Cooperative Water Supply Operations

Results are based on following assumptions:

Simulation year **2020**
 Model 5.22.singleres.mox simulation through 1000 timesteps
 Status quo simulation, March 24, 2003



Jennings Randolph

Model run results: Reservoir storage

	Minimum Storage, million gallons	Minimum percent full (of 2000 capacity)	Occurred on simulation date
Seneca	1,556	40.9%	October 29, 1930
Jennings Randolph	1,309	9.8%	October 26, 1930
Jennings Randolph and Little Seneca combined	2,865	16.7%	October 29, 1930
Patuxent	2,818	27.1%	December 22, 1930
Occoquan	2,333	28.8%	December 25, 1930
System water quality storage	2,281	0.0%	January 18, 1931
JRR water quality storage	1,498	0.0%	January 18, 1931
Savage water quality storage	754	0.0%	January 24, 1931

More model run results:

Percentage efficiency, Jennings Randolph	37%
Percentage efficiency system (JRR and L' Seneca)	45%
# of Patuxent water supply release < 15 mgd.	-
# of Occoquan water supply release < 40 mgd.	-
Number of Potomac allocation events (days)	-
Total shortfall Potomac (mg)	-
Average shortfall Potomac (mgd)	-



Patuxent

References

- Camp, Dresser, and McKee (CDM), 2001. *Study of the Occoquan Membrane Treatment Plant*, Prepared for the Fairfax County Water Authority.
- Department of the Army, 1983. *Washington Metropolitan Area Water Supply Study, Appendix A: Background Information and Problem Identification*.
- Eastman, Paul W., 1986. *Metropolitan Washington Area Water Supply*. Water Resources Planning and Management, ASCE, May 11-16: pp. 57-69.
- Hagen, 2004. Personal Communication.
- Hagen, Erik R., Holmes, John K., Kiang, Julie E., and Steiner, Roland C., 2004 In Review. Benefits of Iterative Water Supply Adequacy Analysis in the Washington D.C. Metropolitan Area. *Journal of the American Water Resources Association*.
- Hirsh, Dr. Robert, Schaake, Dr. John, and Scheer, Dr. Daniel, *Assessment of Current Occoquan Water Supply Situation*. Published by in part by the staff of ICPRB with funding from the US government, US EPA, and signatory States. October 25, 1977.
- Interstate Commission on the Potomac River Basin (ICPRB). Report 98-3: *Occoquan Reservoir "Natural" Daily Inflows*. Rockville, MD. July 1998.
- Interstate Commission on the Potomac River Basin (ICPRB). Report 98-4a: *Patuxent Reservoirs: "Natural" Daily Inflow Development*. Rockville, MD. October 1998.
- Interstate Commission on the Potomac River Basin (ICPRB). Report 98-5: *Jennings Randolph Reservoir "Natural" Daily Inflows*. Rockville, MD. August 1998.
- Interstate Commission on the Potomac River Basin (ICPRB), 2000. Report No. 00-06: *Year 2000 Twenty-Year Water Demand Forecast and Resource Availability Analysis for the Washington Metropolitan Area*. Rockville, MD.
Available at www.potomacriver.org/water_supply/coop-pubs.htm
- ICPRB, Interstate Commission on the Potomac River Basin, *Draft PRRISM Model Documentation*, November 2001.
- ICPRB, Interstate Commission on the Potomac River Basin, *Draft North Branch Potomac Reservoir Operations Model: Users Guide*, December 2002.
- ICPRB, Interstate Commission on the Potomac River Basin, *Draft Technical Manual: Modeling the North Branch Potomac Reservoir Operations*, December 2002.
- Palmer, Richard N., Smith, James A., Cohon, Jared L., and ReVelle, Charles S., Reservoir Management in Potomac River Basin, *Journal of the Water Resources Planning and Management Division, ASCE, Vol. 108 No WR1*, March 1982, pp. 47-66.
- Peck, Col. James W., 1982. Bloomington Lake – Potomac River Water Resources Project. *Civil Engineering*,(6) 47-49.

Scheer, Daniel P. and Staff Members of the Water Resources Planning Board, 1983. Washington Metropolitan Washington Council of Governments. A Perspective on the Washington Metropolitan Area Water Supply Problem, pp. 11.

Scheer, Daniel P. and Flynn, Kevin, 1983. Water Supply. *Civil Engineering*, ASCE, June, pp.4.

Scheer, Daniel P., Baeck, Mary Lynn, and Wright, Jeff, 1989. The Computer as Negotiator. *Journal of the American Water Works Association*. February, pp. 68-73.

Schwartz, Stuart S., 2000. Multiobjective Management of the Potomac River Consumptive Use. *Journal of Water Resources Planning and Management*, September/October pp. 277-287.

Trombley, T.J. 1982. *Downstream effects of the Reservoir Releases to the Potomac River from Luke, Maryland, to Washington, D.C.*, Water Resources Investigations Report 82-4062, United States Geological Survey, Towson, Maryland.

U.S. Corps of Engineers (COE), 1963. *Potomac River Basin Report*. Department of the Army, U.S. Army Engineer Division, North Atlantic, Baltimore Basin Studies Branch. Baltimore, MD.

US Army Corps of Engineers (COE), Baltimore District, 1999. *Master Manual for Reservoir Regulation: North Branch Potomac River Basin West Virginia, Pennsylvania and Maryland, Appendix B Savage River Dam Maryland*.

US Army Corps of Engineers (COE), Baltimore District, 1997. *Master Manual for Reservoir Regulation: North Branch Potomac River Basin West Virginia, Pennsylvania and Maryland, Appendix A Jennings Randolph Lake Maryland*.

Washington Metropolitan Area Council of Governments, 2004. Service Areas for Washington Metropolitan Area Water Suppliers and Distributors. Retrieved: April 20, 2004 from the World Wide Web: http://www.mwcog.org/environment/water/watersupply/supply_map.asp.

Washington Star, 1966. Editorial Article: Near Miss. September 18.

Washington Suburban Sanitary Commission, 2004. History of WSSC.

Table of Contents

Background	1
Early Modeling Methods	8
EXTEND	9
Water Supply Resources of the Potomac River System	9
Jennings Randolph Reservoir	9
Savage River Reservoir	9
Little Seneca Reservoir	9
Occoquan Reservoir.....	10
Patuxent Reservoir	10
Potomac River.....	10
Improvements to the Model	13
The Future of the Model.....	13
The Programming Level	13
Note About this Manual.....	13
Section 1 - The Notebook & User Inputs.....	14
1.1 Restriction Triggers.....	14
1.2 Forecast Year	14
1.3 Forecast Alternative	15
1.4 Little Falls Forecast	15
1.5 Seneca Safety Factor.....	15
1.6 Prince William New Service Area	15
1.7 New Power Plants	15
1.8 Load Shift.....	16
1.9 Delta Load Shift.....	16
1.10 Occoquan Hydropower	16
1.11 Daily Demand Patterns.....	16
1.12 Consumptive Demand	16
1.13 Reset July storage.....	16
1.14 User Inputs – North Branch	16
1.15 User Inputs – Membrane	17
Section 2 - Model Timestep and User Inputs.....	20
2.1 Model Timestep	20
2.2 The Input Files	20
Section 3 - Water Supply Demands and the Potomac River.....	22
3.1 Estimating 9-day Demands	23
3.2 Natural Flows on the Potomac in 9-day time.....	25
3.3 Potomac WQ Augmented Flow.....	25
Figure 3.3. Potomac Water Quality Augmented Flow above Little Falls	26
3.4 FCWA Distribution System Requirements.....	26
3.5 Consumptive Use	28
3.6 Buffering the Predicted Demand	30
3.6 Buffering the Predicted Demand	30
3.7 Westernport Water Supply Pipeline	30

3.8 Potomac Flow	30
Section 4 – The Occoquan Reservoir	32
4.1 Occoquan Hydropower	35
4.2 Lake Manassas	36
4.3 Occoquan Net Inflow and Evaporation.....	37
4.4 Dominion Out of Basin Transfers.....	37
4.6 Occoquan Water Supply Withdrawals and Estuary Treatment	38
Section 5 - Patuxent Reservoir	41
5.1 Patuxent Evaporation	41
5.2 Patuxent Water Supply Demands	42
Section 6 - Little Seneca	43
6.1 Little Seneca Water Supply Request	43
6.2 Load Shifting	43
Section 7 - The Upstream Reservoirs (Jennings Randolph and Savage River).....	44
7.1 Water Supply Releases	44
7.2 Estimating Potomac flow at Little Falls in 9 days time.....	44
7.3 Potomac WQ augmented flow.....	44
7.4 Combined Operations of SRR and JRR.....	44
7.5 COE Water Quality Releases	44
7.6 Integrating Water Quality Release Operations into Water Supply Simulation	46
7.7 Combined Operations.....	49
7.8 Savage River Reservoir Operations.....	49
7.9 Time Step Bookkeeping and Display.....	51
Section 8 – Sedimentation and Wastewater Return Flows.....	52
8.1 Sedimentation	52
8.2 Wastewater Return Flows.....	52
Section 9 - Running the Model and Model Results	56
9.1 Running the Model.....	56
9.2 Results within PRRISM	57
9.3 Output to Excel.....	59
References	59

List of Figures

Figure 1-1a. The PRRISM Notebook – User Inputs	18
Figure 1-1b. The PRRISM Notebook – User Inputs (Continued).....	19
Figure 2-1. The Model Timestep.....	20
Figure 3-1. Water Supply Demands.....	22
Figure 3-2. Estimating 9-day Demands.....	24
Figure 3-4. FCWA Distribution System Requirements.....	27
Figure 3-5. The Consumptive Demand Module	29
Figure 3-6. Buffering the Predicted Demand	30
Figure 3-7. The Potomac River Flow Block.....	31
Figure 4-1. Comparison of Water Balance and Spillway Methods.....	32

Figure 4-2. The Occoquan Sub-Model.....	34
Figure 4-3. Occoquan Hydropower Module	35
Figure 4-4. Lake Manassas Water Supply Withdrawals.....	36
Figure 4-5. Net Occoquan Inflow	37
Figure 4-6. Dominion Out of Basin Transfers.....	38
Figure 4-7a. Occoquan Withdrawal and Estuary Sub-Model.....	39
Figure 4-7b. Occoquan Withdrawal and Estuary Sub-Model	40
Figure 5-1. Evaporation Calculations	42
Figure 5-2. Setting Withdrawals for the Patuxent Reservoir System.....	42
Figure 6-1. Little Seneca Water Supply Request Block	43
Figure 7-1. Operating Process for North Branch Water Quality Releases	45
Figure 7-2. North Branch Inflow Calculations	46
Figure 7-3. Determining Available Storage	50
Figure 7-4. SRR Operations Module.....	50
Figure 7-5. JRR Storage Variables	51
Figure 8-1. Reservoir Sedimentation Calculations	52
Figure 8-2. Wastewater Returns Inputs	53
Figure 9-1. The Simulation Setup	57
Figure 9-2. An Example of the Read-Out Block.....	57
Figure 9-3. North Branch Results in the Model	57
Figure 9-4. The PRRISM.xls spreadsheet	59

List of Tables

Table 4-1. Inputs and Outputs to the Lake Manassas Sub-Model.....	36
Table 5.1 Inputs and Outputs to the Patuxent Sub-Model.....	41
Table 8.1 Projected WWTP return flows	54

Appendix A

Glossary of PRRISM Variables

Variable¹	Description
Antietam Q	File input variable, from USGS historical streamflow records
BestOrHighOut	Allows the user to switch a 'best available' forecast (0) or a 'high' (more cautious) forecast (1)
BOPStorIn	Storage at the beginning of the period (BOP).
Broad Run Out	Return flows from Broad Run WWTP near Ashburn, VA, scheduled to be completed by 2020. The model includes a 10.7 mgd wastewater return flow starting in 2020, increasing to 28.9 mgd in 2050.
Capacity-Min Occ Production	The minimum production from Griffith WTP to meet FCWA system wide demands. This value is calculated as the Total FCWA demand minus the Maximum Potomac Production Capacity at Corbalis.
Centered 20-day rolling avg historical demand	Prediction of demands based on 20-day centered rolling average 1991 through 1999 production, adjusted to represent 2000 levels of demand, and further adjusted to represent peak July 1 through October 31 demands that would be expected during a drought year.
Conococheague Q	File input variable, from USGS historical streamflow records
Constant UOSA Q	UOSA return flow (mgd) as a function of simulation year (through 2040). Values added from ICPRB report 98-3.
Consumptive Demand	Water use from the Potomac River to meet a variety of demands. Consumptive demands are a function of historical year and prediction year.
Consumptive DemandOut	The current consumptive demand (MGD). For the summer months of June, July and August, the simulation uses the Summer Demand input table. For the remainder of the year (September-May), the simulation uses the Sept-May demand.
ConsumptiveDemandOut	Total consumptive demand (mgd) = 2000 consumptive demand + New Power Plant demand + Future additional consumptive demand, mgd. The consumptive demand is a function of historical yield and prediction year.
CurrentConsDemOut	The current constant demand (MGD).
Distribution-Min Occ Production	The maximum production from Griffith WTP to meet distribution system constraints for the Occoquan service area.
Dominion Switch	The withdrawals from the Dominion Semiconductor plant can be modeled as 1 mgd or 8 mgd, corresponding to switch value of 0 and 1 respectively.
Emergency Trigger Percentage	
EmergencyReductionOut	Summer Emergency Reduction Percentage - Percentage Demand reduction from Emergency restrictions on water use during June through September (0-10%)
EOPStorOut	End of period (EOP) storage remaining in the Occoquan Reservoir ; a calculated value.
Est of Pot Water Supply Demands	Estimate of water supply demands in 9 days time
EvapIn	Evaporation Rate at the Occoquan Reservoir (in inches). Average evaporation value for the Occoquan Reservoir are presented in Report No. 98-3
FallEmerOut	The Fall Emergency Reduction Percentage - Percentage Demand reduction from Emergency restrictions on water use during May and October (0 to 10%)
FallMandOut	The Fall Mandatory Reduction Percentage - Percentage Demand reduction from Mandatory restrictions on water use during May and October (0 to 15%)
FallVolout	Fall Voluntary Reduction Percentage - Percentage Demand reduction from Voluntary restrictions on water use during May and October (0-5%)
Flow above Little Falls before Little Seneca Release	Simulated flow in the Potomac River just upstream of Little Falls assuming that NO releases are made from Little Seneca to meet environmental flow-by requirements.
Flow downstream Little Falls before Little Seneca and not including JRR WS release	

Flow downstream of DC	Flow that would be expected downstream of Washington DC, after accounting for all upstream withdrawals, WWTP flows, and consumptive demands. The flow is calculated as "flow above Little Falls before Little Seneca release plus Seneca Release plus Potomac Water Supply Demands.
Flow upstream Little Falls before Little Seneca and not including JRR WS release	This variable is the same as "flow above Little Falls before Little Seneca release" but does not include the lagged Jennings Randolph water supply release.
FutureConsDemOut	The future constant demand (MGD).
FutureYearOut	The desired year of analysis, some time in the present or future (i.e..between 2004 and 2040)
Hancock Q	File input variable, from USGS historical streamflow records. The flow was adjusted to represent the flow that would result without any contribution from JRR or SRR watersheds. The hancock flow can then be treated as a natural flow that is supplemented by releases from JRR and SRR.
InflowIn	Natural' inflow from the Occoquan basin during a given time period. 'Natural' inflows are discussed on ICPRB Report 98-3.
JRR release first day lagged WS Luke flow target	
JRRWS Release	Water Supply releases from JRR
Lagged JRR WS Release	Water Supply releases from JRR, lagged to account for the travel time to reach the WMA
Lake Manassas Capacity	The storage capacity of Lake Manassas.
Little Falls Flow Recommendation	The recommended Environmental Flow-by at Little Falls (mgd)
Little Falls Q in 9 days time, no NB	A forecast of river flow at Little Falls in 9 days time given the current flows throughout the Potomac basin. The forecast is based on regression analysis of historical streamflows throughout the watershed. The flow prediction is based on flows from selected Potomac mainstem and tributary flows (Hancock, Antietam, Shenandoah, Monocacy, Seneca), that have been adjusted by appropriate regression factors. The Hancock component does not include any contribution from JRR and SRR.
load shifting	
Man Evap	Evaporation Rate at Lake Manassas (in inches).
Man Min flow Req	The minimum flow to be released from Lake Manassas Dam during a given time period.
Man Nat Inflow	Natural' inflow from the Lake Manassas watershed during a given time period.
Man Storage	Storage at the beginning of the period (BOP).
Man Withdrawal Req	The desired withdrawals from Lake Manassas by the City of Manassas.
Man WS Release	The amount of water desired to be used for Water Supply purposes by the City of Manassas during a given time step.
MandReduction Out	Summer Mandatory Reduction Percentage - Percentage Demand reduction from Mandatory restrictions on water use during June through September (0-15%)
MandRestrictionOut	Mandatory trigger (0.25 or 25%)
Max Occ Withdrawal	The maximum treatment plant production capacity of the Griffith Water Treatment Plant. Model assumptions include the initial capacity of 120 mgd or an expanded capacity of 140 mgd.
Max Potomac Production	The maximum treatment plant production capacity of the Corbalis Water Treatment Plant. Model assumptions include the current capacity of 150 mgd or the Stage III expansion capacity of 225 mgd.
Max West East Transfer	The maximum transfer from the West (Potomac Service Area) to East (Occoquan Service Area).
MaxCapIn	The maximum capacity

MonthIn (Summer or Rest of Year)	The month is a required input to determine Consumptive use patterns. The reduction in streamflow resources (correction) will occur as a result of consumptive demands for either the months of June, July and August (Summer) or September through May as a function of historical year of streamflow data.
NewDemandIn	New consumptive demands (MGD).
NewPlantDemandOut	The total consumptive use of any New Power Plants. Typical input values range from 0 to 50 mgd.
Occoquan Hydro	This variable is set to 1 to include the Occoquan Hydrogeneration as a minor consumptive use in future demands. A value of 0 forgoes models the Occoquan Reservoir without this use.
Pat BOP Storage	Storage at the beginning of the period (BOP).
Pat Capacity	The water supply storage capacity of the Patuxent Reservoir system.
Pat EOP Storage	End of period (EOP) storage remaining in the Patuxent Reservoir ; a calculated value.
Pat Evap	Evaporation Rate at the Patuxent Reservoirs (in inches). Average evaporation value for the Patuxent are presented in Report No. 98-4a
Pat Min Flow Req	The minimum flow to be released from the Patuxent (Duckett Dam) during a given time period.
Pat Spill	The flow released from the Patuxent (Duckett Dam) during a given time period; This is a calculated value.
Pat WS Release	The flow released from the Patuxent (Duckett Dam) for WSSC Water Supply during a given time period; This is a calculated value.
Pat WS Request	The amount of water desired to be used for Water Supply purposes from the Patuxent Reservoir system during a given time step.
Patuxent Inflow	'Natural' inflow from the Patuxent basin during a given time period. 'Natural' inflows are discussed on ICPRB Report 98-4a.
Potomac Fraction	The fraction of FCWA retail and wholesale demand that comes from the Potomac service area.
Potomac Water Supply Demands	The combined water supply demands of the WMA
Potomac Water Supply Demands and Flowby	
PowerRelOut	Power release for Hydrogeneration at the Occoquan; a calculated value.
PowerRequestIn	The amount of water desired to be used for Power purposes (hydrogeneration)
Predicted Little Falls Flow	The predicted flow upstream of the WMA water supply intakes. Predicted Little Falls flow is based on Little Falls Q in 9 days time, further modified by upstream water quality augmentation, wastewater return flows and consumptive demand. (Note that wastewater return flows and consumptive demand are a function of forecast year.)
PreJRRWQ Req	Previous JRR WQ Request (during last discrete time interval)
PreSavReleaseReq	Previous SRR Release Request (during last discrete time interval)
PrinceWilliamOut	This variable is set to 1 to include a new service area of 5 MGD for the Prince William County Service Authority. A value of 0 forgoes modeling this potential service area.
Rockville Demands	Consumptive demands from the City of Rockville, in mgd. Demands are a function of the day of the year and simulation year. Future Rockville demands are based on WSSC's 1999 water use normalized to 6.37 mgd for 2000, modified by a factor varying from 1.0 in 2000 to 1.1 in 2020 (City of Rockville, 2000).
Seneca Out	Return flows from Seneca WWTP near Germantown, MD
Seneca Release	Release from Little Seneca
Seneca Requested	The amount of water desired to be released from Little Seneca to meet consumptive and environmental flow-by requirements.

Seneca Safety Factor	A margin of safety is used to ensure that releases from Little Seneca can meet consumptive demands and environmental flow-by targets at Little Falls. This helps to protect against localized losses between Little Seneca and Little Falls and uncertainty forecasts in Natural Flow in the Potomac.
SpillOut	The flow over the Occoquan Dam during a given time period; This is a calculated value.
UOSA Flow Out	The product of future constant UOSA Flow and UOSA Production Factor
UOSA Production Factor	UOSA production is a function of month. Summertime return flows are lower than winter flows.
Vol Restriction PercOut	Voluntary trigger (0.6 or 60%)
VolReductionOut	Summer Voluntary Reduction Percentage - Percentage Demand reduction from Voluntary restrictions on water use during June through September
WQ Augmented Flow	Flow in the Potomac River from 'Natural' inflows and Water Quality releases from JRR and SRR
WQ BOP Stor In	Water quality storage available in JRR at beginning of discrete time step interval period.
WQ Inflow In	The portion of inflow into JRR during a discrete time step that fills the reservoir volume dedicated to Water Quality storage.
WQ RequestIn	The amount of water desired to be released from JRR to meet water quality objectives; requests determined from the Rule Curves that mimic COE Master Manual operations and COE professional judgment.
WQ Start Stor In	Water quality available in JRR at beginning of simulation.
WQBOP TotAvail	Total available water quality storage in JRR at the beginning of the discrete time step interval period
WS InflowIn	The amount of natural inflow forecast for the JRR watershed. Natural inflows for JRR are presented in ICPRB Report No. 98-5.
WS Luke Target	The amount of flow released from Water Supply storage that can be used to meet water quality objectives at Luke, MD.
WSBOP StorIn	Storage at the beginning of the period (BOP).
WSCapIn	The amount of storage in JRR dedicated to Water Supply Use for the WMA.
WSReleaseOut	Water supply release from the Occoquan Reservoir; a calculated value.
WSRequestIn	The amount of water desired to be used for Water Supply purposes during a given time step.
WSRequestIn	The amount of water desired to be used for Water Supply from the Occoquan purposes during a given time step.
WSStartStorIn	The storage level in JRR to assume at the beginning of the simulation period.
YearIn	The historical consumptive demand (correction to the natural flow) is a function of simulation year, modeled in PRRISM as a straight line decrease from the beginning of the flow record (1929) to zero (in the year 2000). Thus, the flows are corrected to account for a summer demand of 129 MGD in 1929 (the year 2000 consumptive demands). The historical flows for the September through May period are corrected linearly starting at 42 MGD in 1929 and ending at zero for the year 2000.
2020demand?	Consumptive Uses can be set to held constant at 2020 levels or be simulated as a function of the forecast year. Zero = constant 2020 demand, 1 = variable demand as a function of forecast year'
9-day hence deficit	Any potential shortfall between the total estimated demands 9 days in the future and predicted Little falls flow. It is based on the difference between 'Estimated demands plus flowby plus buffer' and predicted Little Falls flow'

Appendix B

Modeling the North Branch Potomac Reservoir Operations

Modeling water quality operations in the North Branch Potomac

Jennings Randolph Reservoir (JRR) on the North Branch Potomac River and Savage Reservoir on the Savage River are both operated by the U.S. Army Corps of Engineers, Baltimore District (Baltimore COE) to improve water quality in the North Branch Potomac River. Together, these two reservoirs regulate flow in the North Branch downstream of Luke, MD, below the confluence of the North Branch and the Savage River.

Baltimore COE has documented the procedures that they follow in determining water quality releases from Jennings Randolph and Savage Reservoirs in the reports, *Master Manual for Reservoir Regulation North Branch Potomac River Basin, Appendix A, Jennings Randolph Lake*, and *Appendix B, Savage River Dam* (hereafter referred to as the *Master Manual*). ICPRB has drawn heavily upon these resources in modeling current North Branch operations. Reservoir releases are also determined by professional judgment, and ICPRB is indebted to Stan Brua of the Baltimore COE for his help in understanding how the Baltimore COE uses its professional judgment in making release decisions. A significant challenge in modeling this system is attempting to model both the art and science of release decisions.

Overview of North Branch operations

JRR and Savage Reservoirs are operated to use as much of the available water quality storage as needed every year to produce the greatest possible improvement in water quality downstream in the North Branch Potomac while also meeting target elevations at each reservoir. While meeting other project purposes, operational policies seek to maximize the minimum flow from each reservoir without running out of water. Joint regulation of the two reservoirs is used to meet water quality and other goals. The release rules for water quality at both reservoirs are based on the expected inflow rate and the volume of remaining storage in the lake. These operating rules have been modeled using the simulation software Extend™.

To determine a release rate, the Baltimore COE estimates the percentile of the current flow into the reservoir, and uses this percentile to estimate expected inflow in the future. The future flow trend is expected to follow the trend established by the current percentile flow, e.g., if flow is currently in the 10th percentile, then the 10th percentile inflow is expected for the coming months. Next, the amount of storage available for releases while still meeting storage targets defined by the rule curve are determined. The amount of water expected to be available from inflow or current storage is then used to determine the release rate. These steps are documented in more detail below.

Estimating current flow percentile

Baltimore COE looks at flows once every few weeks, in order to estimate the current flow and corresponding flow percentile at each reservoir. During periods of rapidly

changing flow, flows may be reviewed more frequently. Recent flows are examined to develop an estimate of the current flow. If a recent storm has come through, higher flows are disregarded. If flows are decreasing, the lowest flows are given more weight in determining a current flow percentile. An algorithm was developed to approximate this process for both Jennings Randolph Reservoir and Savage Reservoir.

Inputs to the algorithm include a time-series of flow data for eight consecutive days. The algorithm sorts the flows, averages the five smallest values, compares this average flow with the most recent flow value, and takes the smaller of either the computed average or most recent flow value. Figure 1 shows a graphic that illustrates the inputs and outputs of this algorithm, as implemented using the object-oriented program Extend™. Flow inputs are in blue, and the flow output is in red. Similarly to how the Baltimore COE determines current flow, the algorithm tends to disregard peak flows, and if flows are decreasing the algorithm gives more weight to the recent low flows. Note that the output of this algorithm is a rough approximation of the baseflow for the flow regime.

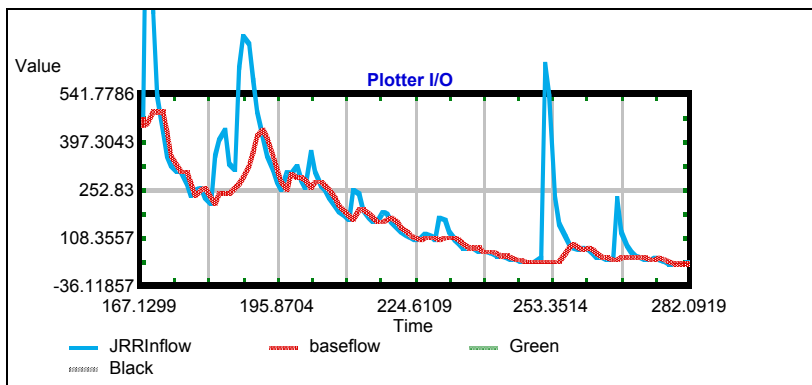

Figure 1: Example input flow series (blue) and output (red) from model subroutine in Extend

After the current flow has been determined for each reservoir, the COE estimates the percentile of that flow amount using plots of monthly average inflow for each reservoir given in the *Master Manual*. In the Extend modeling environment, the same process is modeled using a lookup table, shown in Table 1 for Jennings Randolph Reservoir and Table 2 for Savage Reservoir. The tables were created by calculating the monthly average flow at different percentile levels. They can be used to estimate the current flow percentile by reading across the row for a given month to find the percentile flow that is closest to the current flow for that month. For example, at Jennings Randolph Reservoir given a flow of between 78 and 131 mgd in January, Table 1 returns a flow percentile of 5%.

Table 1: Inflow percentile by month for Jennings Randolph Reservoir.

Month	Jennings Randolph Reservoir Inflow Percentile													
	1%	3%	5%	7%	10%	15%	20%	30%	40%	50%	60%	70%	80%	90%
	Flow (mgd)													
January	73	77	131	153	164	201	227	268	336	372	431	533	595	686
February	129	138	148	170	197	283	304	348	437	499	536	599	694	776
March	262	351	355	366	380	428	446	486	542	604	671	779	846	978
April	154	226	249	267	285	307	332	375	445	527	604	641	715	786
May	110	121	134	144	150	158	179	231	294	429	458	487	553	625
June	45	48	56	59	64	76	87	112	138	161	214	286	364	389
July	21	26	27	31	40	46	55	63	72	92	123	182	228	334
August	19	20	25	31	34	38	42	48	64	98	110	141	187	275
September	15	19	19	21	22	25	32	40	46	55	77	95	130	223
October	16	18	20	24	25	29	36	53	69	77	94	133	201	304
November	21	30	39	58	65	82	92	116	145	170	191	233	288	371
December	46	63	77	96	113	163	178	255	290	333	390	433	546	597

Table 2: Inflow percentile by month for Savage Reservoir.

Month	Savage Reservoir Inflow Percentile													
	1%	3%	5%	7%	10%	15%	20%	30%	40%	50%	60%	70%	80%	90%
	Flow (mgd)													
January	18	22	35	38	41	52	55	88	100	114	139	179	192	247
February	32	42	50	54	66	84	89	110	143	165	184	208	246	296
March	83	108	120	123	142	146	158	185	202	228	247	289	343	394
April	53	64	66	72	92	101	107	126	160	175	212	241	280	329
May	32	34	39	44	46	52	57	83	97	127	149	177	213	231
June	10	13	14	16	18	22	24	28	37	42	57	78	113	141
July	4	5	5	5	8	10	11	13	17	18	22	36	46	74
August	2	3	4	4	4	6	7	10	11	13	19	23	31	53
September	1	2	3	3	4	5	5	6	8	9	13	19	27	70
October	2	3	3	4	4	5	5	8	10	16	23	29	51	109
November	3	4	5	8	10	12	15	22	36	47	57	80	101	134
December	3	7	11	13	19	27	39	62	80	91	121	148	204	226

Determining expected inflow

Management of water quality releases from Jennings Randolph and Savage Reservoirs requires prediction of streamflow, usually over a several month time period. The calculation of expected inflow assumes that the inflow in upcoming months will follow the pattern (percentile) of recent flows. The Baltimore COE uses the current flow trend to look up expected inflow using graphical tools (“consecutive monthly flow frequency curves”) given in the *Master Manual*.

These consecutive monthly flow frequency curves are based on gage flows at Kitzmiller, MD. The consecutive monthly flow frequency curves were prepared over two- to five-month periods, depending on the desired time horizon over which the Baltimore COE wishes to make a forecast of flow volume.

The graphical tools used by the Baltimore COE were approximated in a lookup table format that can be used in a modeling environment to determine expected flow given inputs of current flow percentiles and time of year. The lookup tables that were developed for this purpose are shown in *Table 3* and *Table 4*. The percentile flows shown in *Table 3* were developed based on a statistical analysis of daily inflows to Jennings Randolph Reservoir as developed in ICPRB report no. 98-5. Seventy years of streamflow record were used to develop the analysis. Similarly, the percentile flows shown in *Table 4* for Savage Reservoir were based on a statistical analysis of 70 years of daily inflows as developed by ICPRB.

The values in *Table 3* and *Table 4* were developed as follows. For each forecast interval, total flow was summed for each year of the flow record. For example, in the period January 1 through March 1, total daily inflow was summed for each year in the historical streamflow record. For each forecast interval, this total flow was divided by the number of days in the forecast interval, resulting in an average flow for each year over the forecast interval. These average flows were then ranked by percentile and are provided in the tables for each forecast interval and for each percentile level used by the model. These calculations were conducted in an excel spreadsheet (JRRPercentileInflow3.xls).

The values shown in *Table 3* and *Table 4* assume that the Baltimore COE utilizes the forecast intervals shown in column 1 of the table. These forecast intervals were selected to include a refill period and a summer/fall drawdown period. The JRR drawdown season includes an intermediate September 1 target, as the Baltimore COE makes efforts to maintain reservoir storage at JRR at levels allowing use of the boat ramp through Labor Day weekend.

The values shown in *Table 3* and *Table 4* have been programmed into the Extend™ modeling environment. In determining an expected inflow, the model assumes the current month as the row input, and looks up the current flow percentile in order to determine the expected daily inflow for the given forecast interval. For example, given a 5 percentile flow in June, the model would output an expected inflow of 44 mgd, which is the average inflow to Jennings Randolph that would be expected to occur at the 5th percentile over the forecast interval of June 1 through September 1.

Table 3: Expected average daily inflow by percentile for various forecast intervals for Jennings Randolph Reservoir

		Jennings Randolph Reservoir Expected Inflow by Percentile													
Current month through end of forecast interval	1%	3%	5%	7%	10%	15%	20%	30%	40%	50%	60%	70%	80%	90%	
		Expected average daily inflow through end of forecast interval, units of mgd													
Jan 1 to Feb 1	73	76	133	150	166	200	228	276	335	372	435	532	588	702	
Feb 1 to Apr 1	309	318	342	349	360	380	407	482	506	559	613	682	715	818	
Mar 1 to Apr 1	259	349	353	371	382	434	446	491	539	601	681	768	856	976	
Apr 1 to Jun 1	215	248	254	259	268	279	297	350	405	461	502	550	589	640	
May 1 to Jun 1	109	118	132	142	149	156	178	242	290	423	454	483	544	617	
Jun 1 to Sep 1	41	43	44	45	53	66	75	94	120	140	175	201	262	308	
Jul 1 to Sep 1	26	31	31	32	34	41	52	65	87	109	140	176	217	292	
Aug 1 to Sep 1	19	21	25	31	34	38	41	48	63	97	108	143	184	268	
Sep 1 to Dec 1	18	24	35	43	45	58	69	79	99	126	146	162	228	327	
Oct 1 to Dec 1	18	28	39	45	51	63	69	88	112	144	165	188	259	439	
Nov 1 to Dec 1	21	30	40	60	66	82	91	115	148	169	197	241	294	371	
Dec 1 to Dec 31	46	63	77	96	113	163	178	255	290	333	393	438	548	614	

Table 4: Expected average daily inflow by percentile for various forecast intervals for Savage Reservoir.

		Savage Reservoir Expected Inflow by Percentile													
Current month through end of forecast interval	1%	3%	5%	7%	10%	15%	20%	30%	40%	50%	60%	70%	80%	90%	
		Expected average daily inflow through end of forecast interval, units of mgd													
Jan 1 to Feb 28	52	66	80	83	83	87	93	112	127	139	163	186	208	238	
Feb 1 to Feb 28	32	42	50	54	65	84	92	113	146	169	184	211	247	298	
Mar 1 to Mar 31	82	108	120	122	140	146	156	183	202	228	247	290	345	394	
Apr 1 to May 31	64	67	73	78	83	99	104	124	137	166	188	205	225	248	
May 1 to May 31	32	34	39	43	46	52	58	84	100	128	154	178	214	231	
Jun 1 to Nov 30	6	7	10	13	14	16	19	24	30	38	43	53	61	74	
Jul 1 to Nov 30	4	5	7	10	11	13	13	18	23	30	39	45	57	76	
Aug 1 to Nov 30	3	5	6	7	9	10	12	14	23	27	39	47	61	78	
Sep 1 to Nov 30	3	4	5	6	7	9	12	14	22	28	39	51	67	95	
Oct 1 to Nov 30	3	4	5	6	7	9	12	15	27	34	46	65	83	118	
Nov 1 to Nov 30	3	4	5	8	10	12	15	22	36	47	57	80	101	134	
Dec 1 to Dec 31	3	7	11	13	19	27	39	62	80	91	121	148	204	226	

Rule Curves/Expected Available Storage

The COE uses rule curves to define target reservoir storage levels for different times of the year. During the drawdown season, the storage available for release is the difference between current storage and a future target storage. During the refill season, if reservoir storage is below the target storage, there is no storage available for release and the difference between the current storage and a future target storage must be met by inflow.

The rule curves defining target storage levels throughout the year are shown in Figure 2 and Figure 3 for Savage Reservoir and Jennings Randolph Reservoir, respectively. Multiple rule curves exist for each reservoir and were taken from the *Master Manual*.

The Baltimore COE's use of the different curves and their implementation in the model are described in the sections below.

Savage Reservoir Rule Curves

The COE follows a rule curve that defines target storage levels throughout the year for Savage Reservoir (Figure 2). Savage Curve A defines the upper limit of storage while Savage Curve B defines the optimal storage levels. Reservoir operations normally incorporate storage targets on Savage Curve B. However, in very dry conditions, storage may drop below Savage Curve C, at which point releases are limited to the legal minimum of 20 cfs. If storage drops below Savage Curve D, only releases for Westernport water supply are permitted.

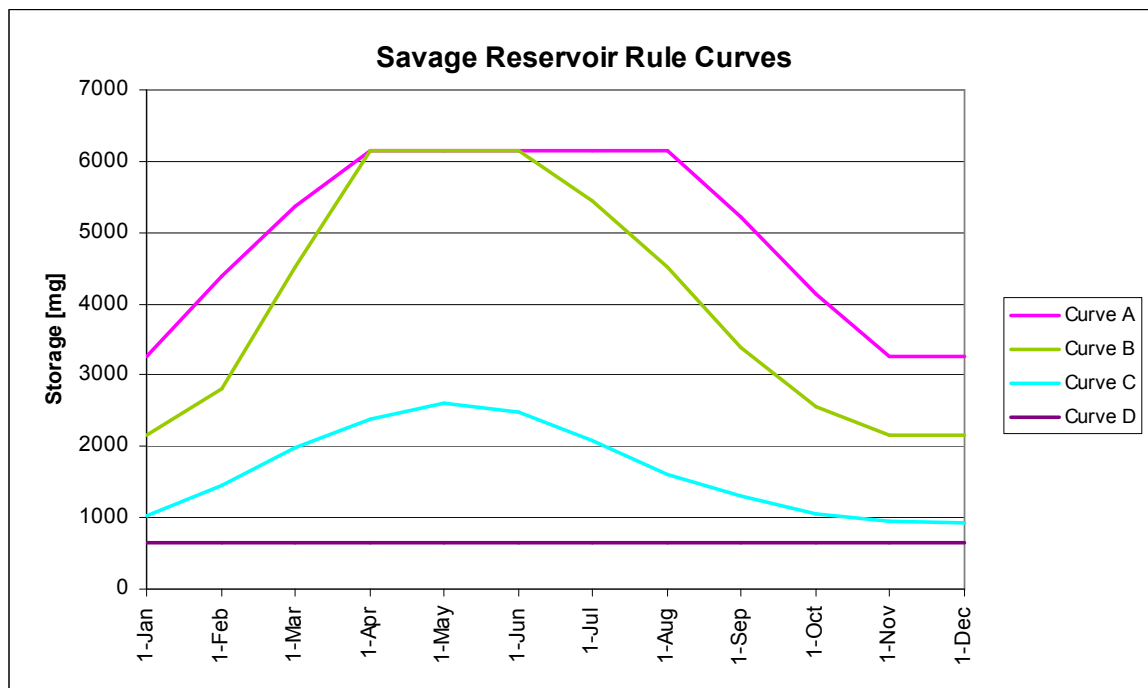

Figure 2: Savage Reservoir Rule Curves

The model uses Savage Curve B to set target storage and expected available storage rates. The target storage is determined by adding 30 days to the current day's timestep and finding the Curve B storage value associated with that date. This target storage is subtracted from the current storage in the reservoir to obtain the expected available storage. This quantity is divided by the number of days to the storage target to get the release rate possible from expected available storage. This release rate is added to the expected inflow to obtain the total calculated release rate. The calculated release rate at Savage Reservoir is overridden if storage drops below Savage Curves C or D, when releases are limited to the specified minimums. The calculated release is also overridden if storage rises above Savage Curve A, the upper limit of storage. Any storage above Savage Curve A is quickly released to draw the reservoir down.

Adjustments to the calculated release rate can also be made to meet whitewater and fisheries interests as described in more detail elsewhere in this report.

Jennings Randolph Rule Curves

At Jennings Randolph Reservoir, the Baltimore COE has published rule curves based on the available storage in the water quality portion of the reservoir storage. These curves make the implicit assumption that water supply storage is 100% full. The published rule curves are shown in Figure 3.

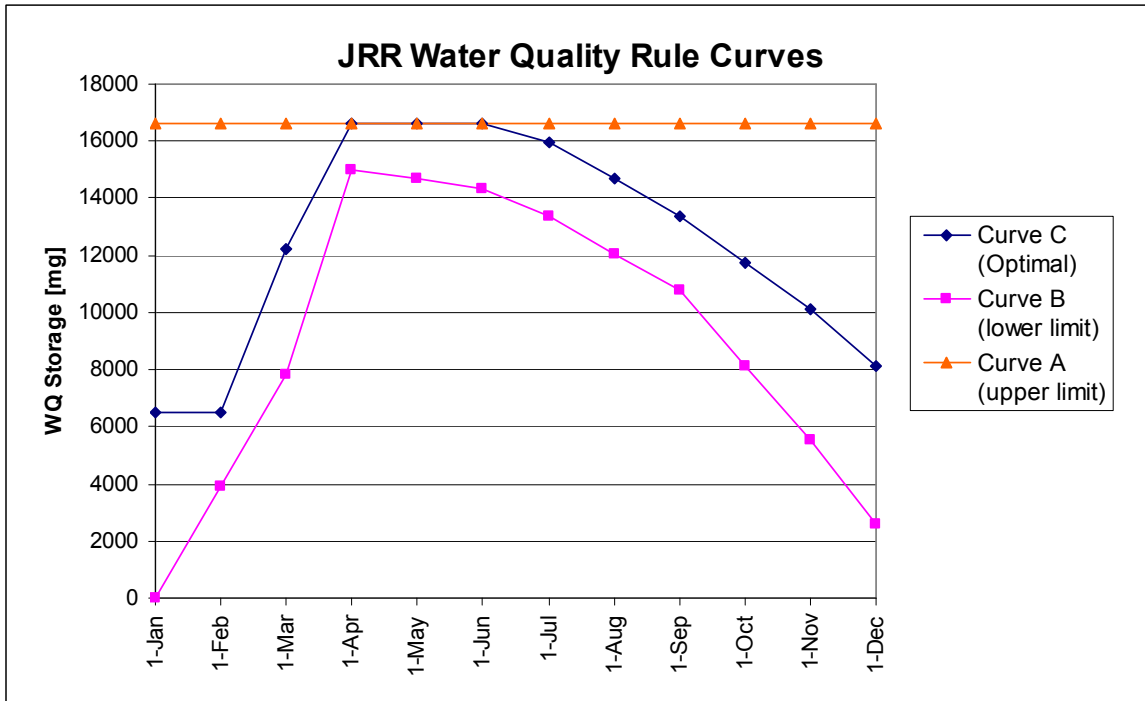

Figure 3: Jennings Randolph Reservoir published rule curves

In actual operations, the COE incorporates a rule curve target of 1445 feet on Labor Day. An elevation of 1445 feet will allow boating through the end of Labor Day weekend. When water supply releases are made, the total storage in the reservoir is affected, and affects the ability of the COE to meet this Labor Day target. Actual COE operations are based on a rule curve target that is based on combined water supply and water quality storage prior to Labor Day, since water supply storage helps the COE to meet this target. Post Labor Day, the COE's water quality operations are based on only that available water quality storage.

ICPRB has incorporated a rule curve into the PRRISM model that is a modification of the COE published rule curves. The rule curve explicitly accounts for water supply storage prior to Labor Day and can be compared to published COE rule curves (Figure 4). This rule curve was further modified to better match modeled parameters with historical parameters such as flow at Luke, and Jennings Randolph and Savage elevations and releases. For example, the November 1 rule curve target was lowered below that of published Curve B to better reflect historical operations.

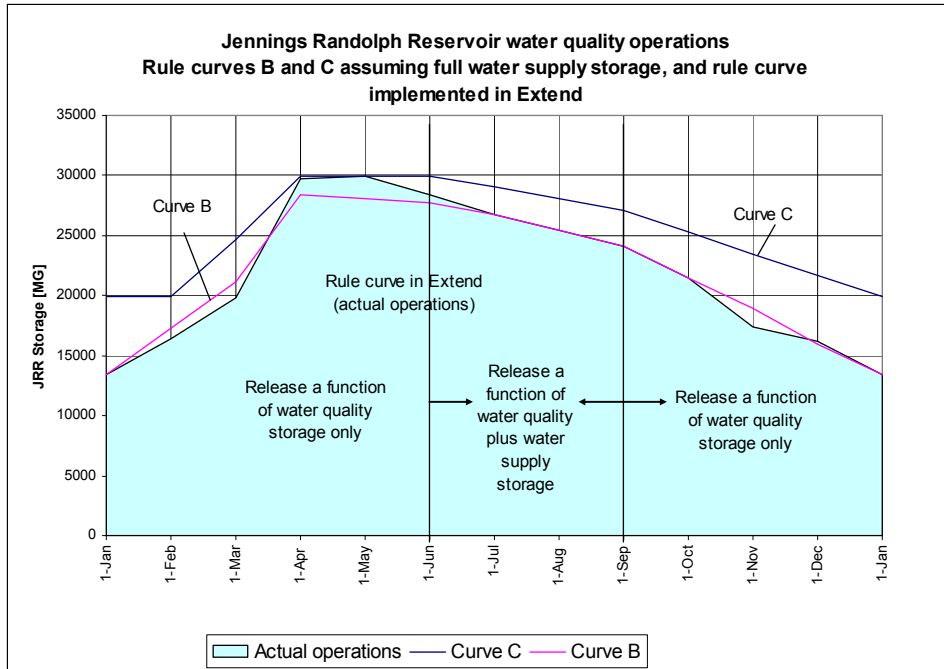

Figure 4: Jennings Randolph Reservoir published rule curves and rule curve used in Extend

JRR Curve A defines the upper limit of storage. Any storage in excess of this amount is quickly released to bring the storage below JRR Curve A. JRR Curve B is associated with a lower range of storage levels, and operations are designed to prevent storage from falling significantly below JRR Curve B even in dry years. JRR Curve C shows the optimal storage levels which are targeted in normal operations, however, historical reservoir storage has been seen to generally follow the rule curve “actual operations” shown in Figure 4. Excursions above JRR Curve A are generally limited to the April to June timeframe, and are otherwise shortlived.

The model derives target storages throughout the year. Targets are 30 days beyond the current timestep. The algorithm is slightly different depending on time of year, i.e., whether, or if as occurs between June 1 and September 1, as explained in more detail below.

Between June 1 and September 1

The release is a function of both water quality storage plus water supply storage. The “actual curve” shown in Figure 4 is used to determine the target storage 30 days in the future. This value is subtracted from total storage in Jennings Randolph (the sum of the current timestep’s water supply plus water quality storage). The remainder is divided by 30 to determine that timestep’s available water for water quality releases. The equation is:

$$(Total\ water\ supply\ plus\ water\ quality\ storage - Target\ based\ on\ "actual\ curve") / 30 = available\ storage$$

Prior to June 1 and after September 1

The release is a function of water quality storage only. The “actual curve” shown in Figure 4 is used to determine the target storage 30 days in the future. Water supply storage capacity is subtracted from this target to determine a revised target based on water quality storage only. This revised target is subtracted from the current timestep’s water quality storage. The remainder is divided by 30 to determine that timestep’s available water for water quality releases. The equations are:

- 1) $(\text{Target based on “actual curve”} - \text{water supply capacity}) = \text{revised target};$
- 2) $(\text{water quality storage} - \text{revised target})/30 = \text{available storage}.$

The expected available storage is obtained by subtracting the target storages from the current storage. This storage volume is divided by the number of days remaining before reaching the storage target date to obtain the release rate possible from expected available storage. This release rate is added to the expected inflow to obtain the calculated release rate.

The calculated release rate can be overridden to fulfill minimum release goals, or to limit large releases when storage is not full. The minimum required released rate from JRR is 50 cfs (32 mgd). In addition, there is a minimum flow requirement of 93 cfs (60 mgd) at Luke, MD, downstream of both JRR and Savage Reservoir. In practice, though, the Baltimore COE typically operates for a Luke minimum flow of 120 cfs (78 mgd). The model checks that the calculated release is actually higher than the 50 cfs JRR minimum and if not, increases the release rate to 50 cfs. In addition, the model checks that the combined JRR and Savage release is greater than the Luke target of 120 cfs. If not, the JRR release is adjusted appropriately.

As the rule curves indicate, Jennings Randolph Reservoir has a refill target date in early April. During the refill period, the *Master Manual* indicates a typical release rate of 250 to 300 cfs (160 to 194 mgd). The model uses a minimum release rate of 300 cfs (194 mgd) during the refill season (defined as January 1 to March 31 in the model) to mimic Baltimore COE operations. During the remainder of the year, this higher minimum release rate of 300 cfs (195 mgd) is used only if the model is following Rule Curve C.

The model also sets maximum release rates in order to build reservoir storage. If the storage is less than 16.0 bg, then the release is limited to 3,000 cfs (1,940 mgd). If the current storage is less than 12 bg and the model is following the lower Rule Curve B, then the release is further limited to 300 cfs (194 mgd).

Whitewater releases are not currently implemented at Jennings Randolph Reservoir.

Artificially varied flows

The Baltimore COE implements artificially varied flow periods when flows have been low for an extended period of time. During extended periods of low flow, suspended materials settle out and accumulate on the river bed. The artificially varied flow is a

large release sustained for 1 to 2 days that is intended to prevent accumulation of these materials, which can degrade the aquatic habitat.

The artificially varied flows have not yet been implemented in the model.

Whitewater releases

On September 1 and September 15, whitewater releases are scheduled at Savage Reservoir. The releases are carried out only if the calculated release rate leaves more than 3.0 billion gallons (bg) of water in the reservoir. If this criteria is met, then an additional 190 mgd of water is releases from the reservoir, equivalent to 7 hours at 1000 cfs.

Fisheries – lake level.

Adjustments to the release can be made to meet fishery lake level targets. During the month of May, in which fish spawn in the lake, reservoir releases can be adjusted either upwards or downwards to keep the lake level stable.

Fisheries – minimum winter and early spring flows

The model mimics COE procedures in keeping flows downstream of Jennings Randolph at least in the 300 cfs range in the months of January, February, and March if enough water is available (i.e., if storage is greater than rule curve C). When storage is greater than rule curve C, the release is the greater of 300 cfs or the release calculated by the standard rule curve procedure. If storage is less than Curve C but greater than Curve B, then the release is between the 300 cfs and the release determined by rule curves, based on a weighted average of how far storage is below rule Curve C – the closer to rule curve C, the closer the release is to the 300 cfs level. When storage is less than curve B, the release is the prerelease.

Model validation

Using the operational rules described in previous sections, the model calculates reservoir releases from Jennings Randolph and Savage Reservoirs, reservoir storage, Luke flow, and a variety of metrics related to the simulation's success in meeting water quality, water supply, fisheries, and other goals. In this section, we will focus on the model validation, i.e., the ability of the model to reproduce historical reservoir releases, reservoir storage, and downstream flow.

Figure 5 shows the modeled vs. historical reservoir storage in Jennings Randolph Reservoir, and *Figure 6* shows the modeled vs. historical outflow from Jennings Randolph Reservoir. The vertical axis shows only flows under 1000 cfs, as we are focusing mainly on simulation during lower flow periods. These figures show that in some years, for example the last couple years shown, the model does remarkably well in matching observed reservoir storage and outflows at low levels. We can also see that the model is not always able to emulate COE operations, as seen in the divergence between modeled and observed reservoir storage in the fall and winter of 1995.

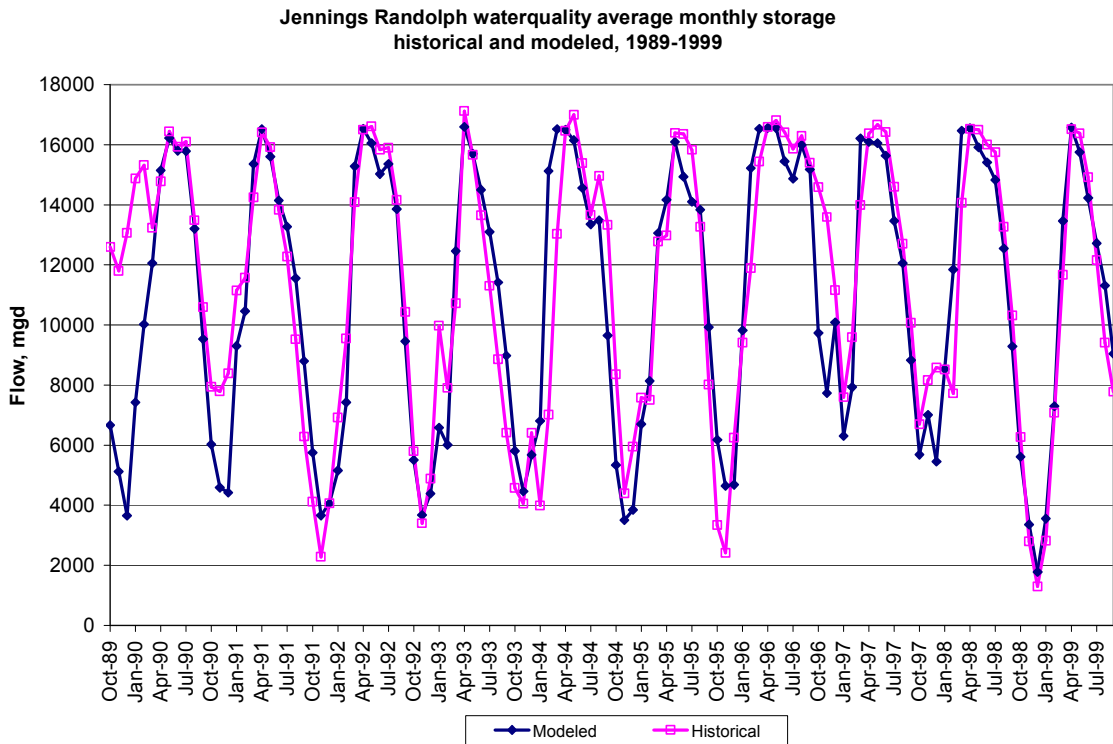
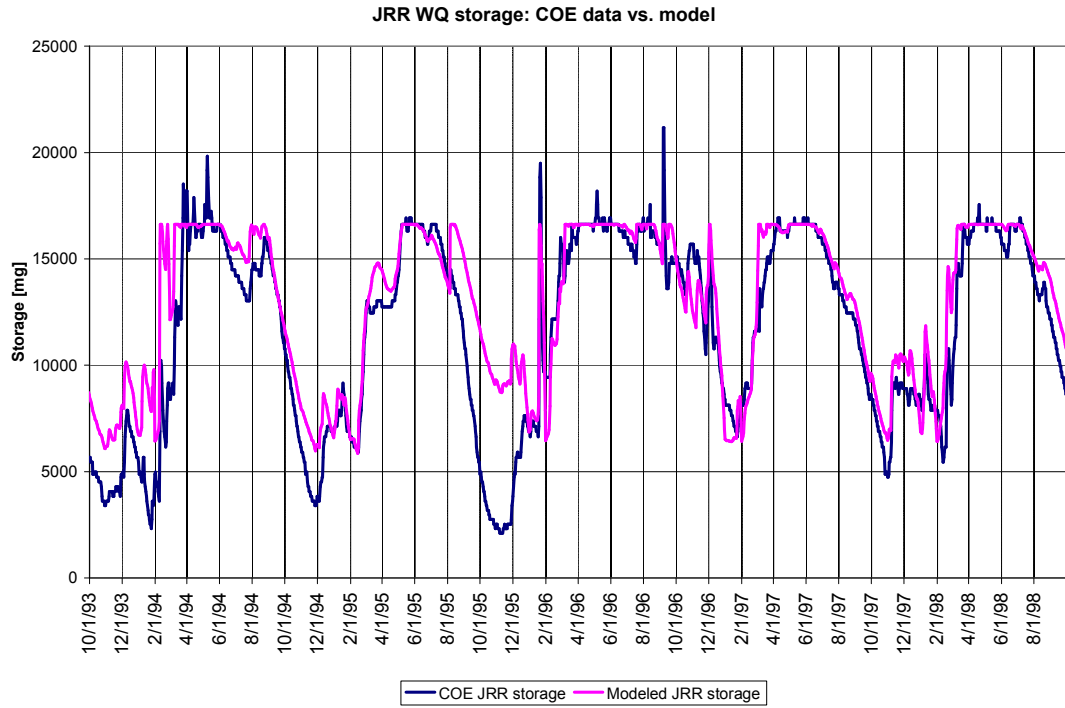

Figure 5: Historical versus modeled storage at Jennings Randolph Reservoir, daily and average monthly

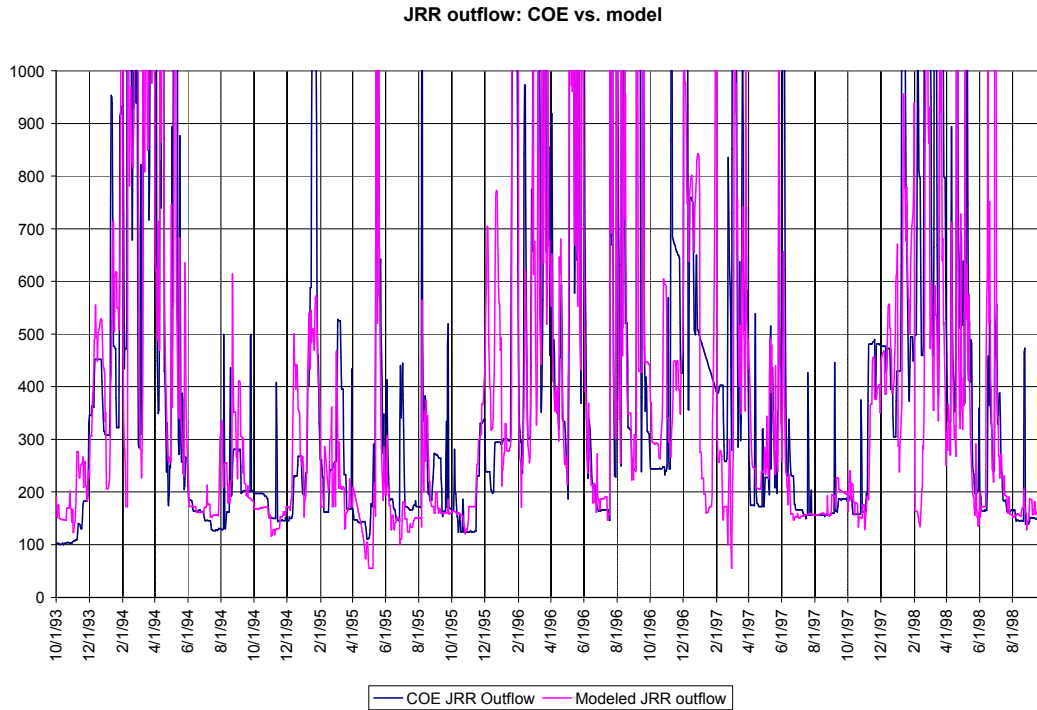

Figure 6: Historical versus modeled daily outflow from Jennings Randolph Reservoir

Figure 7 and Figure 8 show reservoir storage and reservoir releases at Savage Reservoir. Again we see that the model is able to simulate historical storage and releases well in most time periods, within acceptable tolerances, i.e., they are close enough to historical levels to adequately represent the system.

Figure 9 and Figure 10 show the modeled vs. historical flow at Luke, MD, downstream of both reservoirs. The model is able to simulate historical storage and releases well in most time periods.

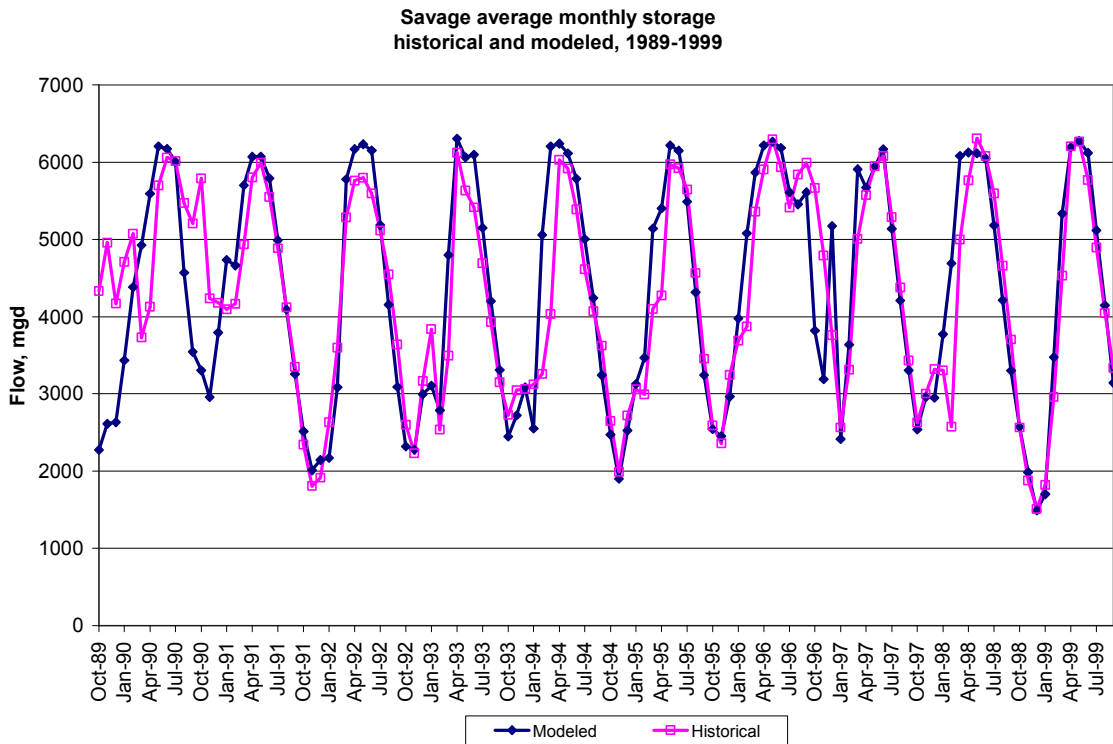
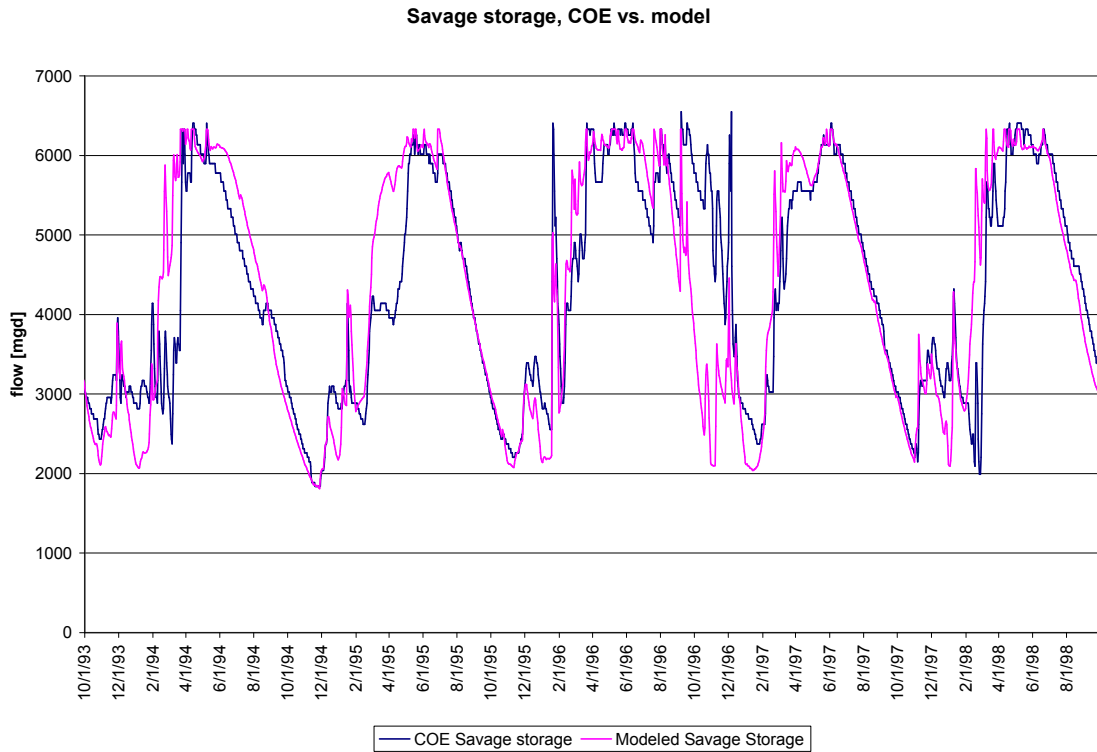

Figure 7: Historical versus modeled storage at Savage Reservoir, daily and average monthly

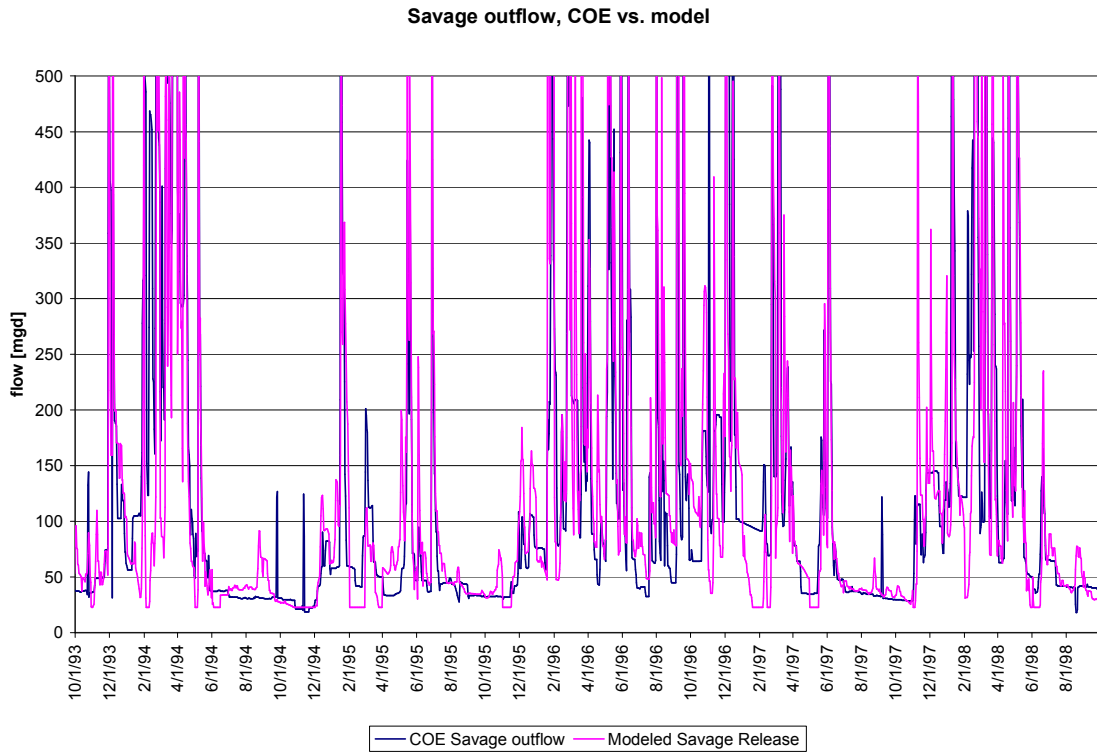

Figure 8: Historical versus modeled daily outflow from Savage Reservoir

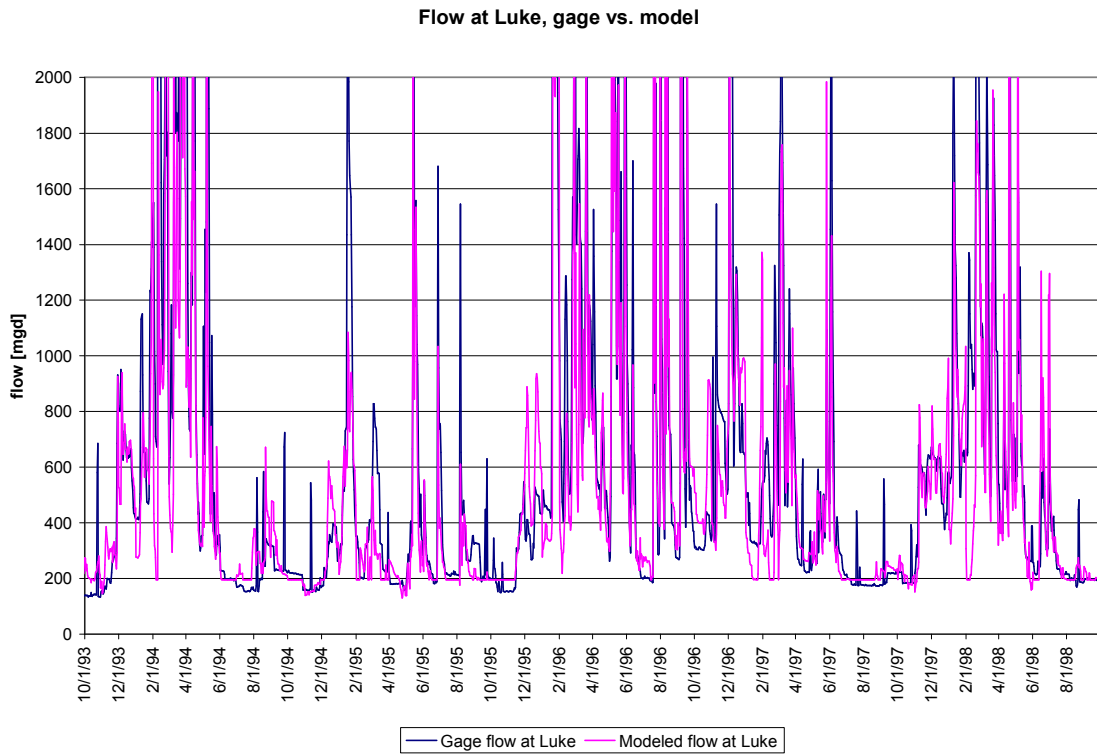

Figure 9: Historical versus modeled daily flow on the North Branch Potomac River at Luke, MD.

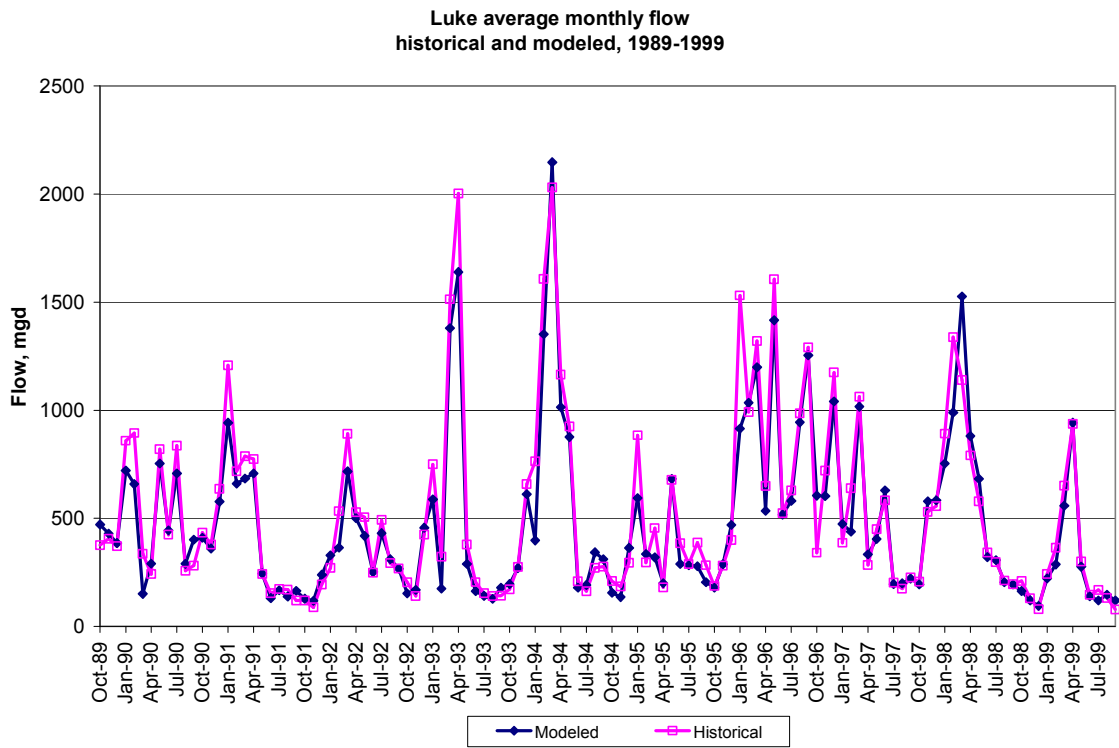

Figure 10: Historical versus modeled average monthly flow on the North Branch Potomac River at Luke, MD.

Table 5: Historical versus modeled monthly flow on the North Branch Potomac River at Luke, MD.

Comparison of modeled and historic flows at Luke, MD, 1989-1999

		year											
month	Data	1989	1990	1991	1992	1993	1994	1995	1996	1997	1998	1999	Grand Total
1	Historic		858	1208	270	749	764	884	1531	387	892	243	779
	Modeled		720	942	328	587	398	594	914	474	753	222	593
2	Historic		894	718	533	322	1607	295	991	638	1337	364	770
	Modeled		658	660	364	175	1352	334	1034	437	990	286	630
3	Historic		336	787	891	1513	2030	455	1320	1063	1139	651	1018
	Modeled		151	685	717	1380	2148	319	1199	1016	1527	558	970
4	Historic		242	774	527	2003	1164	180	650	284	791	936	755
	Modeled		291	707	501	1639	1014	200	534	334	881	942	704
5	Historic		820	242	505	378	924	677	1606	449	578	300	648
	Modeled		753	245	418	289	875	682	1416	404	682	276	604
6	Historic		424	153	249	204	208	384	524	582	341	146	321
	Modeled		445	131	251	163	179	289	517	629	320	139	306
7	Historic		836	173	492	153	163	289	628	202	297	168	340
	Modeled		708	167	431	141	192	282	580	196	307	120	312
8	Historic		257	170	292	140	271	388	985	175	212	131	302
	Modeled		289	138	311	127	343	278	944	199	205	147	298
9	Historic		281	119	267	142	276	283	1292	226	195	78	294
	Modeled		401	165	266	179	311	205	1254	221	195	119	312
10	Historic	375	433	120	204	171	209	186	341	207	210		246
	Modeled	472	410	128	152	196	155	179	605	194	164		265
11	Historic	405	379	87	140	275	184	281	721	529	130		313
	Modeled	430	360	119	169	270	136	288	603	578	121		307
12	Historic	370	636	193	425	658	294	399	1174	556	79		479
	Modeled	386	577	239	457	612	363	469	1041	583	94		482
Average Historical		383	532	394	400	560	669	394	982	440	512	309	519
Average Modeled		429	480	359	364	481	618	344	888	439	517	292	480