

Hajj Crowd Analysis: Incidents and Solutions

By

Almoaid Abdulrahman A. Owaidah

B.Sc. (Hons.) in Management Information Systems, King Abdulaziz University, 2007

M.S. in Information Systems, University of Wollongong, 2010

M.Sc. by research in Computer Science, University of Glasgow, 2015

Supervised by

Winthrop Professor/ **Mohammed Bennamoun**

Associate Professor/ **Doina Olaru**

Associate Professor/ **Ferdous Sohel**

&

Dr/ **Nazim Khan**



This thesis is presented for the degree of Doctor of Philosophy of The University of Western Australia

School of Computer Science and Software Engineering

The University of Western Australia

2022

THESIS DECLARATION

I, **Almoaid Owaidah**, certify that:

This thesis has been substantially accomplished during enrolment in this degree.

This thesis does not contain material which has been submitted for the award of any other degree or diploma in my name, in any university or other tertiary institution.

In the future, no part of this thesis will be used in a submission in my name, for any other degree or diploma in any university or other tertiary institution without the prior approval of The University of Western Australia and where applicable, any partner institution responsible for the joint-award of this degree.

This thesis does not contain any material previously published or written by another person, except where due reference has been made in the text and, where relevant, in the Authorship Declaration that follows.

This thesis does not violate or infringe any copyright, trademark, patent, or other rights whatsoever of any person.

This thesis contains published work and/or work prepared for publication, some of which has been co-authored.

Signature:

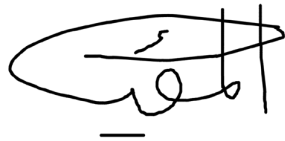
A handwritten signature in black ink, consisting of a large, stylized loop followed by a vertical line and a horizontal line at the bottom.

Date: 09/06/2022

ABSTRACT

Mass Gathering (MG) events bring people together at a specific time and place, which, if not properly managed, could result in crowd incidents (such as injuries), the quick spread of infectious diseases, and other adverse consequences for participants. Hajj is one of the largest MG events, where up to 4 million people can gather at the same location at the same time every year. In the Hajj, pilgrims from all over the world gather in Makkah city in Saudi Arabia for five specific days to perform rituals at different sites.

The facilities at the ritual places can become congested and occasionally overcrowded when there are a lot of pilgrims. Overcrowding at Hajj events makes crowd control and management difficult, resulting in many accidents, casualties, and traffic jams. This thesis investigates new simulation and modelling-based crowd management strategies in order to overcome the overcrowding problem at pilgrimage sites and ensure safe and efficient transport of pilgrims. A Discrete Event Simulation (DES) tool called "Extendsim" is used to test and validate all simulation models on real Hajj data from previous years, in normal and emergency situations, at different ritual sites, and the impact of arrival scheduling and pilgrim movement between the holy sites.

In Chapter 2, a systematic review of the literature describes the evolution of crowd modelling and simulations for Hajj. These studies focus on two main topics: Tawaf and Sayee rituals at the Grand Mosque and crowds at the Aljamarat Bridge. The prior simulation studies have treated Tawaf and Sayee separately even though they are carried out within the same space and time envelope.

Chapter 3 analyses overcrowding at the Tawaf and Sayee levels in the Grand Mosque (GM). Crowd modelling and simulation are used here for developing models and validating them with real data from both rituals. Different scenarios are developed to identify the effectiveness of changing the pilgrims' distributions at the GM under normal conditions, and different evacuation scenarios are also developed to identify areas and pathways for evacuation from the GM. The main findings indicate that the Main Tawaf area and Sayee GL could accommodate up to 80% of the pilgrims, while other Tawaf and Sayee levels can accommodate up to 30%. In addition, the evacuation process is conducted smoothly without building up crowds and using the nearest exits. Crowded spots and when they might occur are identified.

Chapter 4 examines the rituals at the new Aljamarat Bridge (AB). While the current plan includes developing timetables of the activities, allocating specific routes and levels for pilgrim groups, establishing schedules and following a unidirectional movement system to prevent counter flows, crowd incidents could still occur. For this reason, crowd modelling and simulating normal and evacuation scenarios at AB are developed in order to examine proceedings, especially during situations that require emergency evacuation from the bridge. The results confirm that the evacuation

durations are longer when arrivals are random than when they are scheduled. Overall, these evacuation times are shorter than a previous related study. Additionally, closing more than one tower during an evacuation lengthens the evacuation process. The results of this study confirm the importance of the scheduling methods to manage crowds on the bridge during evacuations.

Chapter 5 describes how the pilgrims could overcrowd the roads, trains, and pedestrian routes, causing traffic jams and congestions. A lack of adequate transport timetables, scheduling and a lack of coordination between modes of transport could further deteriorate conditions. In order to reduce the total transport duration from one site to another and change pilgrim allocations to modes of transportation, transport models and scenarios are developed.

Changing the timetables leads to shorter travel times compared to real data and produces better results than changing the percentages of pilgrims by mode of transport. Transport managerial strategies are proposed to assist with the transport management.

Finally, Chapter 6 concludes this thesis by summarising each chapter, the main contributions, recommendations, and provides future research directions. The Hajj authorities could use the new crowd management and transport methods in their planning process prior to Hajj event to organise the movements of the pilgrims at the GM and Aljamarat Bridge, as well as between the sites.

TABLE OF CONTENTS

Chapter 1 : Introduction	2
1.1. General Background	2
1.2. Research Problems	3
1.2.1. Problem A: Overcrowding at the Holy sites	3
1.2.2. Problem B: Complex pilgrim movements and traffic jams – transport management	5
1.2.3. Potential solutions: Current Hajj crowd management	5
1.2.4. Potential solutions: Current Hajj transport management	7
1.3. Literature Review and research gaps	7
1.3.1. Crowd modelling and simulation for crowd management improvements	7
1.4. Study motivation	10
1.5. Aims of the thesis	11
1.6. Research questions	11
1.7. Research methods	12
1.8. Significance of the research	13
1.9. Thesis Outline	14
References	15
Chapter 2 : Review of Modelling and Simulating Crowds at Mass Gathering Events: Hajj as a Case Study	20
Abstract	20
2.1. Introduction	20
2.2. Literature Search Framework	22
2.3. Hajj as a Case Study	23
2.3.1. Hajj Holy Site	24
2.3.2. Hajj Rituals	27
2.4. The Significance of Hajj event	28
2.5. Complexity of Crowd Management for MG Events	29
2.5.1. Crowd management at Hajj	29
2.5.2. Overcrowding at Hajj Holy Sties	30
2.6. Previous Hajj crowd incidents and their main causes	32
2.6.1. Incidents at the Grand Mosque	32
2.6.2. Incidents at Aljamarat Bridge, Mina	32
2.6.3. Incidents at Arafat and Muzdalifah	33
2.6.4. Observations on past incidents	33
2.7. Literature Survey Results	33
2.7.1. Crowd modelling and simulation Types	33
2.7.2. Significance of Crowd Modelling and Simulation	35

2.7.3. Previous Haj Simulation Studies	36
2.8. Discussion	46
2.9. Conclusion	49
Acknowledgement.....	49
References.....	49
Appendix: PRISMA 2009 Flow Diagram.....	53
Chapter 3 : Modelling Mass Crowd Using Discrete Event Simulation: A Case Study of Integrated Tawaf and Sayee Rituals During Hajj	62
Abstract.....	62
3.1. Introduction	62
3.2. Literature Review.....	64
3.2.1. Hajj characteristics	64
3.2.2. Crowd management	65
3.2.3. Crowd modelling.....	65
3.2.4. Crowd modelling and simulation for Hajj events.....	66
3.2.5. Evacuation modelling and simulation for Hajj events.....	69
3.3. Contribution of the work	72
3.4. Data Resources and Methodology.....	73
3.4.1. Data collection sources.....	74
3.4.2. Model development.....	75
3.5. Modelling and simulation implementation	75
3.5.1. Tawaf and Sayee at The Grand Mosque.....	75
3.5.2. Tawaf and Sayee simulation.....	78
3.6. Simulation Results.....	83
3.6.1. Model validation	84
3.6.2. Tawaf and Sayee scenarios	86
3.7. Discussion of Results.....	92
3.8. Conclusion and future work	100
Acknowledgements.....	102
References.....	103
Appendix – Block and Input data used in simulation.....	106
Chapter 4 : Modelling and Simulating Aljamarat Bridge Rituals.....	109
Abstract.....	109
4.1. Introduction	109
4.2. Related work	111
4.3. Methodology and data sources.....	112
4.4. Modelling and Simulation Implementation	113
4.4.1. Aljamarat Bridge Features.....	113
4.4.2. Aljamarat Bridge Three Pillars model: attributes, conditions and main ExtendSim blocks	114

4.5. Model Validation and Developing Evacuation Scenarios	115
4.6. Discussion	117
4.1. Conclusion	120
Acknowledgment	120
References	120
Chapter 5 : Transport of Pilgrims During Hajj: Evidence from a Discrete Event Simulation Study	123
Abstract	123
5.1. Introduction	123
5.2. Hajj transport management	125
5.2.1. Hajj vs the Olympics transport management	126
5.2.2. Management of Hajj	128
5.2.3. Transport modes used during Hajj	128
5.2.4. Transport problems at Hajj	131
5.3. Relevant Literature for Simulation	132
5.4. Data Sources	137
5.5. Modelling and simulation implementation	137
5.5.1. Hajj Transport Model in ExtendSim	139
5.5.2. Model Validation	147
5.6. Hajj scenarios	148
5.7. Results of Scenarios	150
5.7.1. TM 1 - Makkah to Mina	150
5.7.2. TM 2 - Makkah and Mina to Arafat	152
5.7.3. TM3 - Arafat to Muzdalifah (Al-Nafrah Movement)	155
5.7.4. Buses rearrangement for transport models	156
5.8. Conclusion	161
Acknowledgment	163
References	163
Appendix – Tables	166
Appendix – Figures	168
Chapter 6 : Conclusion	171
6.1. Thesis Summary	171
6.2. Contributions of the Thesis	174
6.3. Translation into Practice	175
6.4. Limitations and Lessons Learned	176
6.5. Future Work	177

LIST OF FIGURES

Figure 1-1: Numbers of pilgrims at Hajj (Ascoura et al., 2013, The General Authority for Statistics - Kingdom of Saudi Arabia, 2022).....	4
Figure 1-2: Broad taxonomy of crowd simulation models (Authors' work).....	9
Figure 1-3: Crowd modelling and simulation steps (Papageorgiou et al., 2009).....	12
Figure 2-1: Hajj holy sites, Makkah City (using Google Maps).....	25
Figure 2-2: Aljamarat Bridge. Source: Edrees (2016).....	27
Figure 2-3: Snapshot of TawafSim simulator. Source: Khan & McLeod (2012).....	37
Figure 2-4: Simulating 100,000 agents to evacuate from Aljamarat Bridge. Sources: Klüpfel (2007).....	45
Figure 2-5: PRISMA flow diagram for the literature review.	53
Figure 3-1: Data sources and data formation process.....	74
Figure 3-2: The Grand Mosque map (source: The General Presidency of The Affairs of The Grand Mosque and The Prophet's Mosque, 2020).....	77
Figure 3-3: LoS depending on the allocation percentages.....	78
Figure 3-4: (A) Executive Block, (B) Create Block, (C) Set Blocks, (D) Get Blocks, (E) Queue Block.	79
Figure 3-5: A: Entry activities. B: Tawaf activities. C: Entry equations. D: Tawaf equations. E: Walking activity from Tawaf to Sayee.	82
Figure 3-6: (A) Sayee activities and equations. (B) Exit activities, (C) Exit Blocks, (D) Plotter Blocks.....	83
Figure 3-7: Allocated groups.....	90
Figure 3-8: Total number of groups of pilgrims at areas of Tawaf, Sayee, in transit between Tawaf-Sayee and the cumulative number of groups that had exited the GM, over time.....	92
Figure 4-1: Aljamarat Bridge features (in a level) (Authors' elaboration).....	113
Figure 4-2: Evacuation exits and pathways (Authors' elaboration)	116
Figure 4-3: Evacuated pilgrims and evacuation (BAU) durations.....	119
Figure 5-1: Hajj transport network (routes for buses, trains, and pedestrians) (www.Hajjtraffic.com).....	129
Figure 5-2 Movement 1 from Arafat to Muzdalifah from 6 pm on the 9th of Zil-hijjah to 2 am on the 10th (Al-Sabban and Ramadan 2005. p. 76)	133
Figure 5-3: Transport operations at Hajj 2019	138
Figure 5-4: Mina-Arafat Movement patterns of Al-Mashaer Metro during Hajj (by permission from Kaysi et al. 2012, p.257)	139
Figure 5-5: Pilgrims' numbers and movements between the holy sites on the 8 th of Zil Hijjah from Makkah to Mina, and 9 th from Makkah and Mina to Arafat and from Arafat to Muzdalifah (Department of Transport, Ministry of Hajj, 2019)	146
Figure 5-6: Transport Module (TM) 1 represents the movement of pilgrims from Makkah to Mina on the 8th of Zil Hijjah.....	168
Figure 5-7: TM1 (A) Unbatch, (B) Transport, (C) Resource, (D) Batch (E) Exit, and (F) Plotter blocks.....	168
Figure 5-8: TM1 Example Equations Block	168
Figure 5-9: Transport Module (TM) 2 represents the movement of pilgrims from Makkah to Arafat (Conventional buses) (C) and Mina to Arafat by, Shuttle buses (A), Conventional buses (B), trains/railways (D) and Pedestrian routes (E).....	169

LIST OF TABLES

Table 2-1: Keywords for the analytic search of the literature. Note: Both US and UK/Australian spelling were considered in the search.....	23
Table 2-2: Hajj rituals, their dates and challenges.....	28
Table 2-3: Anylogic results. Source: Mahmood et al. (2017)	41
Table 2-4: Analysis of previous studies	47
Table 2-5: Selection criteria for the literature review.....	54
Table 2-6: PRISMA Checklist.....	57
Table 2-7: Classification of MG events.....	58
Table 2-8: Past incidents at the Grand Mosque (Al-Masjid Al-Haram).....	59
Table 2-9: Past incidents at Mina city	59
Table 2-10: Past incidents at Arafat and Muzdalifah	60
Table 3-1: Halabi (2006) evacuation results.....	70
Table 3-2: Abdelghany et al. (2010) evacuation results	71
Table 3-3: Validation of arrivals and exit (statistics).....	84
Table 3-4: Tawaf Activity – Validation.....	85
Table 3-5: Sayee Activity – Validation	85
Table 3-6: Tawaf and Sayee scenarios	87
Table 3-7: Regression results (sensitivity analysis).....	87
Table 3-8: Allocations for the Tawaf and Sayee Scenarios.....	93
Table 3-9: Simultaneous Tawaf and Sayee scenarios and results.....	96
Table 3-10: Results of simultaneous Tawaf and Sayee scenarios	99
Table 3-11: Comparison of evacuation results with previous studies	99
Table 3-12: Number of evacuated groups in the evacuation model	100
Table 3-13: ExtendSim Blocks Used in the Models (Laguna and Marklund, 2013; ExtendSim User Reference, 2020).....	106
Table 3-14: Pilgrim speeds (m/s) at Hajj event for each Group, Fitness and Age (Dridi, 2015).....	106
Table 3-15: Pilgrims incident rates from Hajj events 2002-2015 (Bianchi, 2017).....	107
Table 3-16: Distances from the main gates to Ka’aba and starting line (The General Presidency for the Affairs of the Two Holy Mosques, Al-Maqdad app, 2019)	107
Table 4-1: Main types of blocks included in the simulation model	115
Table 4-2: Aljamarat Bridge Validation.....	117
Table 4-3: Duration of evacuation and number groups using six towers (scheduling scenario - BAU)	118
Table 4-4: Duration of evacuation and number groups using six towers (random arrivals – Poisson 600 groups/hour)	118
Table 5-1: Comparison between sport events and Hajj [based on Kassens-Noor (2010)].....	127
Table 5-2: Pedestrian routes at Hajj (Mohsen and Shihatah 2012, p. 10).....	131
Table 5-3: Number of pilgrims transported by buses from site to site (Department of Transport, Ministry of Hajj, 2019).....	142
Table 5-4: Train operations between the holy sites.....	143
Table 5-5: Validation of module 1 - from Makkah to Mina by Conventional buses on the 8th day	147
Table 5-6: Validation of module 2 - from Makkah and Mina to Arafat by all transport modes on the 8th and 9th days.....	147
Table 5-7: Validation of module 3 – from Arafat to Muzdalifah (Al-Nafrah movement) by all transport modes on the 9th day	148
Table 5-8: Selection of developed transport scenarios	149
Table 5-9: Allocated scenarios’ results of TM1	157
Table 5-10: Allocated scenarios’ results of TMs 2 and 3 (% allocation ONLY buses) *	159
Table 5-11: Suggested transport solutions (from Tables 5-9 and Table 5-10).....	160
Table 5-12: Pilgrim speeds at Hajj event (Dridi 2015)	166
Table 5-13: Conventional Bus Operations from Makkah to Mina on the 8 th	166
Table 5-14: Extendsim Blocks Used in the Models (Extendsim User Reference, 2020) [Laguna & Marklund, 2013] *	167
Table 5-15: Planned bus durations vs Actual bus durations from Hajj 2019.....	167

ACKNOWLEDGEMENTS

All praise to Allah - SWT - who gave me strength, guidance and patience for finishing this thesis.

I would like to extend my profound acknowledgement and gratitude to The Custodian of the Two Holy Mosques, his Majesty King Salman Bin Abdulaziz Al Saud and His Roly Highness Prince Mohammed Bin Salman Al Saud, The Crown Prince, the deputy prime minister and the minister of defence of Saudi Arabia – May Allah protect them.

I would like to extend my sincere appreciation and deepest gratitude to my all supervisors, W/Prof. Mohammed Bennamoun, Dr Doina Olaru, Dr Ferdous Sohel and Dr Nazim Khan. This research would have not been possible without their instructions, assistance, efforts, support, guidance, and patience. No words can describe how much I appreciate everything they have done for me.

I would like to thank the ImagineThat company for providing me with ExtendSim software for conducting all my modelling and analysis presented in this thesis. Special thanks to Kathi Hansen, the educational representative of ImagineThat and Cecile Pieper for her technical assistance.

I would also like to thank The University of Western Australia (UWA) for providing excellent research training, an outstanding research culture and a lovely environment. I would like to thank the Graduate Research School (GRS) for easing my PhD candidature procedures and Dr Du Huynh, the GRS coordinator at the school of Computer Science and Software Engineering (CSSE). I also appreciate the contribution of Dr Joanne Edmondston and Dr Kryz Haq who offer valuable guidance for the PhD students through their workshops. Moreover, the GRS has assisted me and other international students like me in every aspect of life inside and outside the university, so thank you.

I do not want to forget to thank my fellow PhD students at CSSE Nayyer Afaq, Asim Jelwan and Hizam Alboqmi. Also, from UWA Business School colleagues Ubaid Momtaz, Mohammed Khaiatah and Sahar Goudarzi.

I would like to acknowledge my sponsor in Australia, the Saudi Arabian Cultural Mission (SACM) in Canberra. My thanks are extended to the internal sponsor and my employer King Abdulaziz University (KAU), Jeddah, Saudi Arabia. I do not forget my boss, Dr Mohammed Sarhan, the Management Information Systems

(MIS) head department, for his constant follow up and support for the staff in the department. Also, my thanks go to the Faculty of Economics and Administration (FEA) and the FEA dean Prof. Naser Kadasa. I thank all KAU leaders as well as the KAU president, Prof. Abdurahman Alyoubi.

I would like to thank the Ministry of Hajj and Umrah for providing data used in this thesis for validation of the models, especially to Dr Mohammed Al-Qarni and Prof. Emad Felemban. In addition, my thanks go to the Custodians of the Two Holy Mosques Institute for Hajj and Umrah Research, to Dr Khaled Osrah, Dr Mohammed Edrees (from the Department of Urban and Engineering Research) and Dr Othman Qazzaz (from the Media Research Department). My thanks to Dr Bassm Ghlman, former Transport Director at the Ministry of Hajj and Umrah and Eng. Ahmed Qari, the operational manager from the Cars General Syndicate (Naqabah).

Finally, I would like to express my gratefulness to my family members. My wife Alaa who stood by my side from the beginning of this journey without any hesitation. I appreciate her being patient, kind, supportive, and caring for our kids, Muhammad and Mariah. My thanks also go to my mother and my elder brother Hazza. Last but not least, this thesis is dedicated to my father's soul, who passed away on the 27th of Oct. 2020 from COVID-19. Rest In Peace, my beloved father.

AUTHORSHIP DECLARATION: CO-AUTHORED PUBLICATIONS

This thesis contains work that has been published and prepared for publication.

Details of the work: [Owaidah, A., Olaru, D., Bennamoun, M., Sohel, F. and Khan, R. N. (2019) "Review of Modelling and Simulating Crowds at Mass Gathering Events: Hajj as a Case Study". <i>Journal of Artificial Societies and Social Simulation</i> , 22 (2) 9 < https://www.jasss.org/22/2/9.html >. doi: 10.18564/jasss.3997]
Location in thesis: Chapter 2
Student contribution to work: 65%
Co-author signatures and dates: Mohammed Bennamoun. M.Bennamoun 8/6/2022 Doina Olaru Olaru 08/06/2022 Ferdous Sohel F. Sohel 8/6/2022 Nazim Khan R. N. Khan 8/6/2022

Details of the work: [A. A. Owaidah, D. Olaru, M. Bennamoun, F. Sohel and R. N. Khan, "Modelling Mass Crowd Using Discrete Event Simulation: A Case Study of Integrated Tawaf and Sayee Rituals During Hajj," in <i>IEEE Access</i> , vol. 9, pp. 79424-79448, 2021. < https://ieeexplore.ieee.org/abstract/document/9439797 >. doi: 10.1109/ACCESS.2021.3083265.]
Location in thesis: Chapter 3
Student contribution to work: 70%
Co-author signatures and dates: Mohammed Bennamoun. M.Bennamoun 8/6/2022 Doina Olaru Olaru. 08/06/2022 Ferdous Sohel F. Sohel 8/6/2022 Nazim Khan R. N. Khan 8/6/2022

Details of the work: [Owaidah, A., Olaru, D., Bennamoun, M., Sohel, F., & Khan, N. (2021, December). A discrete event simulation for modelling Aljamarat Bridge rituals and evacuation scenarios. In <i>24th International Congress on Modelling and Simulation</i> (pp. 477-483). Modelling Simulation Society of Australia & New Zealand. doi/10.36334/modsim.2021.18.richards. https://www.mssanz.org.au/modsim2021/papers/18/richards.pdf
Location in thesis: Chapter 4
Student contribution to work: 75%

Co-author signatures and dates:

Mohammed Bennamoun. M.Bennamoun 8/6/2022
Doina Olaru Olaru. 08/06/2022
Ferdous Sohel F. Sohel 8/6/2022
Nazim Khan R. N. Khan 8/6/2022

Details of the work:

Transport of Pilgrims During Hajj: Evidence from a Discrete Event Simulation Study.
Submitted to **Transportation** Journal.

Location in thesis:

Chapter 5

Student contribution to work: 80%

Co-author signatures and dates:

Mohammed Bennamoun. M.Bennamoun 8/6/2022
Doina Olaru Olaru. 08/06/2022
Ferdous Sohel F. Sohel 8/6/2022
Nazim Khan R. N. Khan 8/6/2022

Student signature:

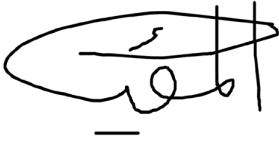

Date: 10/06/2022

We, W/Prof. Mohammed Bennamoun, Associate Prof. Doina Olaru, Associate Prof. Ferdous Sohel and Dr Nazim Khan certify that the student's statements regarding their contribution to each of the works listed above are correct.

Coordinating supervisor signature:



Date: 10/06/2022

LIST OF ABBREVIATIONS

ABM	Agent-Based Models
AMIS	Advanced Mobile Information Systems
API	Application Programming Interface
BL	Basement Level
CA	Cellular Automata
DES	Discrete Event Simulation
F	Al-Fatah gate
FSM	Finite State Machine
GA	Genetic Algorithm
GIS	Geographic Information Systems
GL	Ground Level
GM	Grand Mosque
IOC	International Olympic Committee
K.A.	King Abdullah gate
K.Az.	King Abdulaziz gate
K.F.	King Fahad gate
L1, 2 and 3	Level 1, 2 and 3
LoS	Level of Service
M	Al-Marwah gate
MG	Mass Gathering
MOH	Ministry of Hajj - the Kingdom of Saudi Arabia
MOMRA	Ministry of Municipal and Rural Affairs - the Kingdom of Saudi Arabia
MR	Mobility Reduced
OpenGL	Open Graphics Library
PRISMA	Preferred Reporting Items for Systematic Reviews and Meta-Analyses
RFID	Radio Frequency Identification
SA	Southern Asia
SCD	Saudi Civil Defence
SEA	South East Asia
SFM	Social Force Modelling
SVMs	Support Vector Machines
TEAA	Turkey, Europe, Australia and America
TEs	Tawafa Establishments
TM 1, 2 and 3	Transport Model 1, 2 and 3
U	Al-Umrah gate
VICS	Vehicle Information and Communication System
WHO	World Health Organization

Chapter 1

Chapter 1 : Introduction

1.1. General Background

The World Health Organization defines mass gathering (MG) events as "*a planned or spontaneous events, where the number of people attending is at least 1000 individuals, that could strain the planning and response resources of the community or country hosting the event*" (Ridda et al., 2021, p.2). A crowd at an MG event can be defined as "*a temporary aggregation of people in a certain place for a common cause with or without a previous gathering plan*" (Fruin, 1993; Taibah and Arlikatti, 2015, p.189). This definition applies regardless of language, nationality, gender (Alazbah and Zafar, 2019), or purpose (religious, political, music festivals, sports events, Alshalani et al., 2020).

Many planned MG events are recurrent, held annually or at some regular intervals. Recurrent MG events, such as Olympic Games and the Football World Cup, are held at often different locations (Kassens-Noor 2010, 2013, 2016; Kassens-Noor and Fukushige 2018). Hajj is an annual MG event held in the Kingdom of Saudi Arabia in the holy city of Makkah (Al-Salhie et al., 2014; Abdulkarim et al., 2016; Sehil et al., 2016; Shirah et al., 2017; Alazbah and Zafar, 2019; Felemban et al., 2019a; Felemban et al., 2021; Felemban and Rehman, 2022), and takes place between the 8th and 13th of Zil Hijjah, the last month of the Islamic calendar (Fourati et al., 2017). During Hajj, pilgrims perform rituals at four holy sites; Masjid Al Haram (Grand Mosque), Mina, Muzdalifah, and Arafat (Felemban et al., 2020; Hussain et al., 2021).

Hajj is considered the largest recurring MG event in the world, attracting approximately 3–4 million pilgrims (Fourati et al., 2017; Mahmood et al., 2017; Qurashi, 2018; Alshalani et al., 2020; Sweileh, 2022; Felemban et al., 2021; Hussain et al., 2021).

Qurashi (2018) described the sequence of rituals as follows. Pilgrims start with the Tawaf (circumambulation of Kaaba seven times) at the Grand Mosque, Makkah City; then Sayee (walking and running between the hills of Al-Safa and Al-Marwah located inside the mosque); staying for a day at Arafat until sunset; spending a night at Muzdalifah and collecting pebbles for the stoning devils ritual; then staying for three days in the Tent City of Mina to perform the stoning of the pillars at the Aljamarat Bridge. Pilgrims

return to the Grand Mosque for the Tawaf Al-Ifaddah. Repeating the stoning rituals and they end by performing farewell Tawaf at the Grand Mosque.

1.2. Research Problems

Several challenges make Hajj crowd management more arduous than other events (Al-Salhie et al., 2014; Osman and Shaout, 2014; Taibah and Arlikatti, 2015; Mohamad et al., 2016; Felemban et al., 2019a). According to Khan and McLeod (2012) and Al-Kodmany (2013), Hajj is unique not only because of its size and complexity (specified sequence of rituals at specified times at specified sites) but also due to the heterogeneity of the crowd, comprising pilgrims of all ages, levels of education, and mobility, with different cultural backgrounds, from more than 180 countries. Hajj is spatially and temporally constrained, and pilgrims need to move between the various sites to complete the rituals (Abdulkarim et al., 2016; Alazbah and Zafar, 2019). Below we discuss the problems unique and specific to Hajj.

1.2.1. Problem A: Overcrowding at the Holy sites

A significant problem at Hajj is **overcrowding** at the holy sites (Al-Salhie et al., 2014; Fourati et al., 2017; Felemban et al., 2021). Overcrowding often leads to **lost pilgrims** at Hajj sites, that is, pilgrims separated from their groups and not able to rejoin them. This is a non-trivial issue, and approximately 30,000 pilgrims were lost at different locations in Hajj 2011. This problem occurs mainly among foreign pilgrims unfamiliar with the local area and language (Fourati et al., 2017).

The problem of overcrowding and crowd incidents (injuries and even deaths) is caused by the increasing number of pilgrims each year and the difficulty in anticipating overcrowding hotspots and the likelihood of these incidents (Hashish and Ahmed, 2015; Abdulkarim et al., 2016; Alaska et al., 2017; Fourati et al., 2017; Haase et al., 2019; Yamin, 2019). Past examples include overcrowding at the Aljamarat Bridge in Mina in 2004 resulting in 251 deaths and injuries to 224 pilgrims, and a stampede in 2006 with 346 deaths and injuries to 289 pilgrims (Taibah and Arlikatti, 2015; Alaska et al., 2017). Overcrowding has become a major concern for Hajj crowd management (Felemban et al., 2020).

Figure 1-1 shows the number of pilgrims at Hajj between 2008 and 2019. The number of pilgrims increased steadily until 2012, followed by a sharp decrease in 2012 with numbers remaining relatively constant until 2016, after which numbers increased steadily again. The number of pilgrims often exceeds the number of planned and approved permits. According to the governor of Makkah, in 2012, up to 3.65 million pilgrims performed Hajj, a sharp increase from previous years, because of "illegal pilgrims" (Yamin and Albugami, 2014). During the 2012 Hajj, this led to overcrowding, minor stampedes, which required several interventions. Unauthorised pilgrims have no rights to medical, logistical, transport, or other services. As a result, to control numbers, in 2013, all Muslims, including Saudi citizens, were restricted to perform Hajj once every five years. This was implemented by introducing several checkpoints on access roads to Makkah city during the Hajj period. The attendance in 2013 was reduced also to allow the enlarging and alteration of Al-Masjid Al-Haram, the Grand Mosque (Kamaruding et al., 2020), and other infrastructure works in Makkah city (Taibah, 2015). The work was completed in 2015–2016, and pilgrim numbers increased again henceforth. The steady increase is expected to continue in the near future. According to Saudi Vision 2030, the number of pilgrims is expected to increase significantly in the coming years to reach 30 million Umrah (a smaller pilgrimage than Hajj that can be performed any time in the year) visitors annually and 3.9 million pilgrims at Hajj by 2030 (Yezli et al., 2017).

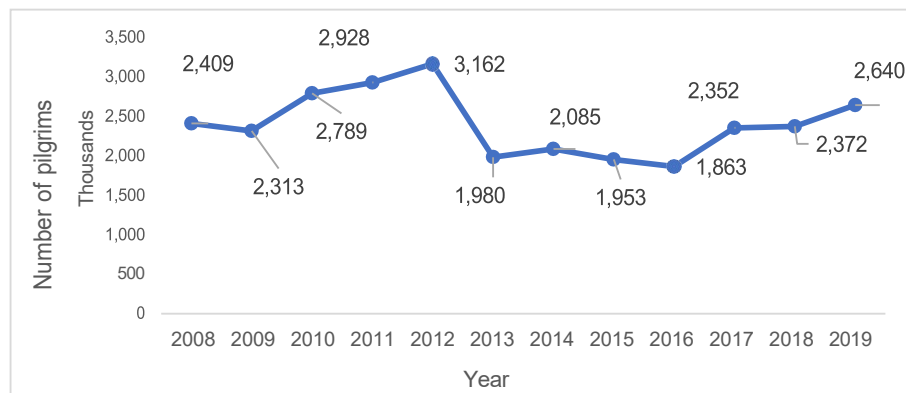

Figure 1-1: Numbers of pilgrims at Hajj (Ascoura et al., 2013, The General Authority for Statistics - Kingdom of Saudi Arabia, 2022)

To maintain stricter control numbers at Hajj, the following restrictions are in place for foreign pilgrims (Ahmed and Memish, 2016):

- National quotas of visas for each of 183 nations every year;

- Visa restrictions, such as permitting individuals to perform once Hajj every five years;
- Monitoring and enforcing requirements of Hajj eligibility, including public health and infection control criteria;
- Visas conditional on required vaccination status, with no exceptions.

1.2.2. Problem B: Complex pilgrim movements and traffic jams – transport management

Another major problem for Hajj organisers is the transport of mass crowds, given the restricted geographical area of the holy sites of Hajj and the limited number of roads connecting the sites (Osman and Shaout, 2014; Al-Sabban and Ramadan, 2005; Fourati et al., 2017; Felemban et al., 2019a). This has resulted in extended queues of vehicles, traffic congestion, delays in proceedings, overcrowding and related incidents (Hanrahan, 2015; Felemban et al., 2019b). The problem has been exacerbated every year due to the growing number of pilgrims (Felemban et al., 2019b). Developing transport plans and continuously monitoring and analysing traffic movements during Hajj are essential to overcome this challenge (Felemban et al., 2019; Felemban and Rehman, 2022). The solutions adopted included investments in infrastructure and transport services (e.g., Al Mashaer Al Mugaddassah railway line, dedicates routes and lanes for shuttle buses, new depots), as well as operational changes (e.g., prior allocation of Tawafa Establishments TEs to transport modes, scheduling of the transport tasks, limited access of other vehicles during Hajj, variable message signs for traffic).

1.2.3. Potential solutions: Current Hajj crowd management

Crowd management is a systematic plan to manage the movement and assembly of a group of people (Fourati et al., 2017). It includes *"providing services to the crowd through effective planning, training, and data collection at crowded events"* (Taibah and Arlikatti, 2015, p.189). Crowd management includes a set of practices for managing and controlling crowd before, during, and after events by dealing with people, locations, facilities, technology and data (Abdulkarim et al., 2016; Alshalani et al., 2020). For Hajj events crowd management includes designing plans and executing actions based on the analysis and causes of previous crowd incidents to prevent them in the future (Al-Ahmadi et al., 2021).

Hajj events are managed by the government of Saudi Arabia, who plan and monitor the entire Hajj event (Felemban et al., 2020). Hajj authorities involve organisers and researchers in the planning process to ensure better crowd management and control strategies (Felemban et al., 2020).

As part of the Hajj crowd management plan, authorities have divided and assigned pilgrims to seven TEs according to their nationalities. These establishments are responsible for transport and accommodation during Hajj (Haase et al., 2019; Hussain et al., 2021; Muneeza and Mustapha, 2021). In addition, pilgrims are allocated into groups of 250, and each group is led by a local guide throughout Hajj (Haase et al., 2019).

Several technologies are implemented to assist with the monitoring and surveillance during Hajj, as detailed below.

- Approximately 800 surveillance cameras have been installed across all sites to monitor the safety and security of pilgrims (Fourati et al., 2017). However, the cameras have limited views, and some large geographical areas covered only with complicated image processing (Felemban et al., 2021).
- Various messaging and information systems were introduced to the Aljamarat Bridge in Mina City, where pilgrims performed an important ritual (stoning the devil). The reconstructed bridge with a new design and multiple levels to improve the comfort of the pilgrims (Fourati et al., 2017; Sharma et al., 2018) can be accessed based on a schedule to guarantee the safety of pilgrims (Felemban et al., 2019), and in the case of emergency a messaging system guides the pilgrims to the nearest exit.
- Individual tags (for transport) and special apps to assist with location and flow management.

All these systems are reviewed and planned before the actual Hajj and adapted during the event to minimise congestion and stagger pilgrims at holy sites or between sites (Alaska et al., 2017; Felemban et al., 2020).

In March 2020, the WHO declared COVID-19 a global pandemic, and Saudi Arab Hajj authorities suspended Umrah to reduce the number of rituals during Hajj, considering that this ritual could be performed at any time during the year at the Grand Mosque (Basahel et al., 2021). In addition, it was decided to admit only 10,000 pilgrims in Hajj 2020 and 60,000 pilgrims in Hajj 2021 (Basahel et al., 2021). The management of the less crowded events was successful, and no COVID-19 cases were recorded during Hajj in these two years (Basahel et al., 2021).

1.2.4. Potential solutions: Current Hajj transport management

As indicated, planning pilgrim movements from one holy site to another during Hajj is a complex task for the Hajj authorities, requiring mass movement of vehicles and pilgrim groups between the sites (Reffat, 2012; Fourati et al., 2017). One of the first measures introduced at Hajj was to prohibit during peak periods access of small cars to Makkah Central, where the Grand Mosque is located (Reffat, 2012; Fourati et al., 2017; Felemban et al., 2019b).

Another measure is managing pilgrim movements through the seven TEs (Felemban et al., 2019b), each accommodated in designated areas and transported using specific modes and routes (Felemban et al., 2019b). This involved two organisations: the Hajj Transport Authority and the General Car Syndicate (or Naqaba), the latter operating under the supervision of the Hajj Ministry. Naqaba serves and supervises nearly 20,000 conventional and shuttle buses from 50 national bus companies (Kassens-Noor, 2010; Sehli et al., 2016; Felemban et al., 2019b). To solve the problem of severe bottlenecks and traffic congestion on the roads, the "Al Mashaaer Al Mugaddassah Metro Line" was operated in 2010 (Manenti et al., 2012; Fourati et al., 2017).

1.3. Literature Review and research gaps

1.3.1. Crowd modelling and simulation for crowd management improvements

Modelling and simulating crowds under various scenarios can help in planning better crowd management and control; this can be used to develop management strategies that lead to better transport plans that avoid or reduce incidents (Quan et al., 2015; Fourati et al., 2017; Alkhadim et al., 2018; Sharma et al., 2018).

In our context, models refer to structures, such as flow charts and algorithms, constructed to display the features and characteristics of Hajj rituals and the transport between locations. A model exposes and extracts the key and salient features of a phenomenon, the connections between parts of a system, their functioning, and the potential cause-and-effect relationships in the system environment. Simulation is the process of designing a model of a real system, based on mathematical logic (Still, 2013; Quan et al., 2015). A simulation model is useful for studying the operation of a system as it evolves (Sharma, 2015). One of the benefits of

simulation is its ability to evaluate different scenarios and assess the sensitivity of the modelled relations by changing the inputs one at a time or simultaneously and observing the effect on the output. This process identifies which variables are the most important for controlling the output (Sharma, 2015).

Crowd modelling and simulation are considered important elements of crowd management, planning and decision making at MG events by conducting safe, low-cost, and harmless experiments (Serova, 2013; Mahmood et al., 2017; Sharma et al., 2018). In Hajj, crowd modelling and emergency evacuation is a unique field that needs more attention, as overcrowding is one of the most challenging tasks for management during emergencies. The safety and security of pilgrims are the primary motivations to use crowd modelling and simulation, to analyse overcrowding and identify crowded locations during Hajj (Alazbah and Zafar, 2019). The aim is to prevent incidents and provide adequate safety and comfort during normal and emergency conditions (Abdulkarim et al., 2016; Mohamad et al., 2016; Mahmood et al., 2017; Namoun et al., 2018; Felemban et al., 2019b; Al-Ahmadi et al., 2021).

Transport management can assist Hajj authorities in planning and finding solutions to alleviate congestion on the road and at sites by using the existing infrastructure and networks more effectively (Seliman, 2001). Consequently, attention should be dedicated to transport modeling and simulation to develop and evaluate alternative solutions before they are implemented (Seliman, 2001; Felemban et al., 2019a). Nasir and Sunar (2016) classified crowd modelling and simulation into microscopic and macroscopic models (Figure 1-2). Microscopic models treat every simulated individual as an autonomous agent 'occupying' a specific location/space at a specific time, endowed with specific attributes such as social behaviour, communication with other agents, and the ability and freedom to make decisions. In contrast, macroscopic models treat the movement of agents as a continuous fluid. This paradigm is focused on improving the crowded environment under normal conditions by finding ways to provide more comfort and fast movement for the simulated individuals. Another criterion for classifying crowd simulators is whether they model the movement of crowds in normal or emergency situations (Sarmady et al., 2007). Emergency models calculate the time required to evacuate a building or an area and are useful for examining congestion at exits and entrances.

The most commonly used crowd modelling and simulation types are presented in Figure 1-2 and are described in more detail in the following sections.

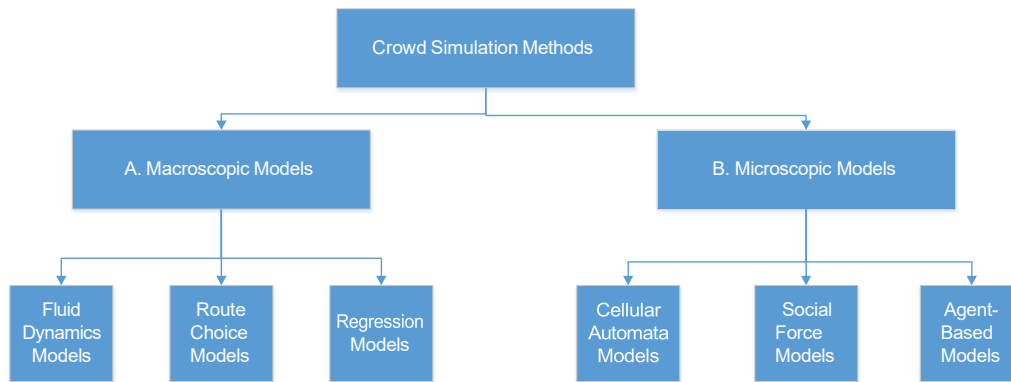

Figure 1-2: Broad taxonomy of crowd simulation models (Authors' work)

1.3.1.1. Macroscopic Models

Macro models are typically used for large crowds at sports stadiums, shopping malls, and transport stations (Xu et al., 2014). These models describe pedestrian movements using metrics, such as crowd flow and speed (Gil, 2014), thus ignoring individual behaviour (Ijaz et al., 2015). They do not consider direct interactions between individuals, and they were developed for the real-time simulation of large crowds (Rabiaa and Foudil, 2016). The major classes of macroscopic models include fluid dynamics, route choice, and regression-based models.

1.3.1.2. Microscopic Models

These models explicitly consider individuals or agents and use individual-level scales. Microscopic models account for each individual's speed, position, and interaction with others (Gil, 2014). The models include actions such as avoiding collisions or overtaking and provides global navigation for each agent. They are used to simulate moves from one place to another separately or in groups (Curtis, 2013; Ijaz et al., 2015; Rabiaa and Foudil, 2016). Microscopic models include cellular automata (CA), social forces (SFM), and agent-based models (ABM).

These microscopic crowd models have been used for Hajj to identify crowd movements and behavioural problems and solve crowd management problems through scenario simulations by examining the outcomes of

various interventions (Owaidah et al., 2019). Chapter 2 of this thesis provides an extensive systematic literature review of the most important crowd modelling, simulation models and techniques. These include Legion and Myriad 2 (AlGadhi and Still, 2003; Al-kodmany, 2013), Simulex (AlGadhi and Still, 2003), MassMotion (Mokhtary, 2017), PedFlow (Dridi, 2014), and NetLogo (Illyas, 2013) as ABM. However, Simwalk (Zainuddin et al., 2009) as SFM, PedGo (Klupfel, 2007), STEPS (Fayoumi et al., 2011), and EXODUS (Siddiqui and Gwynne, 2012) as CA.

However, these studies are focusing on the interactions at the individual level and are not suitable to describe the global state of a system (Conversely, macroscopic models do not have the high fidelity of microscopic models, as their application is aimed at the large-scale system.)

Acknowledging the distinct role of these micro- and macro- level models, this thesis considered modelling and simulating Hajj rituals in normal and emergency situations using “ExtendSim” (DES) by simulating crowds of heterogeneous Hajj pilgrim groups divided according to their observed distinct percentages. The discrete event simulation addresses some of the limitations of the previously used microscopic models:

- lack of integration of pilgrim group behaviours while performing Hajj rituals;
- focus on modelling and simulating localised bottlenecks;
- and modelling a specific activity, rather than the entire Hajj event.

The following chapters present previous studies that applied crowd modelling and simulation focused on the main Hajj rituals (e.g., Tawaf, Sayee, Stoning the Devil) at the Grand Mosque and Aljamarat Bridge, the transport of pilgrims between the Hajj sites, and the simulation models designed as part of this research project.

1.4. Study motivation

Hajj was selected as the case study because it represents one of the world's largest MG events (Khan, 2012) with millions of pilgrims from all parts of the world. Congestion at Hajj sites is a common problem that often leads to emergencies and incidents. If not addressed promptly and satisfactorily, this could lead to lost pilgrims, panic, injuries and even casualties. The motivation of this research is to provide insights and suggest new

managerial methods for crowd management by simulating rituals at all sites and transport tasks between sites, in both normal and evacuation scenarios.

1.5. Aims of the thesis

The overarching objective of the thesis can be summarised in the following specific aims:

- Identify the main behaviours of pilgrims in crowds, causes of unexpected problems that might occur during Hajj, and their likely impact on ritual performance.
- Calibrate and evaluate current Hajj management solutions, as suggested by modelling and simulation.
- Evaluate scenarios for future and unexpected problems that pilgrims might face as groups and individuals, in order to improve Hajj crowd management practices.
- Provide evidence and planning recommendations to support decisions of Hajj authorities in their event planning.

1.6. Research questions

This thesis addresses the following specific research questions:

- Are current Hajj management methods (such as scheduling) effective for crowd management in normal and evacuation conditions from Hajj holy sites and for transportation?
- Can simulation studies of Hajj help develop new methods of crowd management with improved service levels to control the crowds of pilgrims at Hajj holy sites?
- How will the results of simulation studies assist authorities in developing crowd management processes that will minimize the time required for rituals and transportation?
- How will simulation studies help deliver appropriate responses to unexpected overcrowding problems?

1.7. Research methods

This research applies discrete event simulation (DES) to rituals and transport. This modelling method represents the system as a process or a sequence of operations occurring at discrete points in time (Serova, 2013; She et al., 2018), which is similar to Hajj processes as a sequence of activities. These DES processes include delays, resource usage, and waiting in queues (Serova, 2013). DES assists in building models and testing various scenarios by changing the simulation inputs and observing the resulting outputs without disturbing the existing system (She et al., 2018).

The research used the "ExtendSim" platform developed by Imagine That (USA), referred to as ExtendSim hereafter. ExtendSim has been used to model a wide variety of systems in manufacturing, healthcare, logistics, military, and services (Krahl, 2014). It can anticipate business activity results, identify problem areas, evaluate ideas, and optimise activities (Jadrić et al., 2014). ExtendSim has the following features: simulating the systems in steps and processes; performing calculations using equations; interfacing with other applications (such as MS Excel); presenting the results in Plotters; using 3D animations; and creating a user-friendly interface (Krahl, 2014).

The steps followed for the setup, verification, validation, and exploration of crowd and transport simulation models are shown in Figure 1-3 (adapted from Papageorgiou et al. (2009) and are described below.

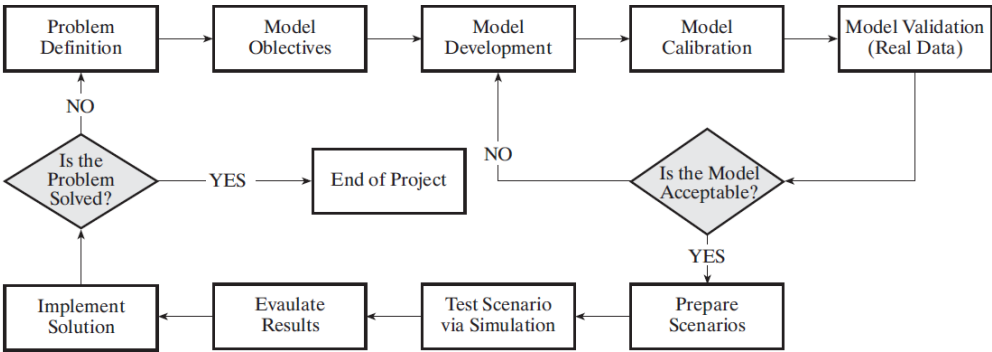

Figure 1-3: Crowd modelling and simulation steps (Papageorgiou et al., 2009)

- Problem definition: Identify the real causes of the problem that is simulated.

- Problem objectives: Specify the purpose of creating the simulation model, the components (parameters of the model), and the inputs (accurate data).
- Model development: Determine the suitable crowd modeling software to be used based on the model objectives.
- Model calibration: The collected data and mathematical and statistical algorithms used in the model activities.
- Model validation (vs. real data): Develop criteria and apply statistical methods (testing hypotheses). If the results between the simulation model and real-world data are different, the developer must repair the model and then repeat this step. In addition, the validation includes the experimental design of the model, understanding the causes of failed experiments, and redesigning the experiment to obtain accurate results.
- Prepare scenarios: Test various scenarios under different circumstances (once the validation step is confirmed) and then evaluate and implement the proposed solution.

The data used in this thesis includes several secondary and primary data sources: data from previous Hajj events from the Hajj and Umrah institutes; interviews; and personal experiences of the author of this thesis.

1.8. Significance of the research

This thesis proposes new crowd management models, based on discrete event simulation, to improve safety, security, crowd management, and control at Hajj holy site facilities to predict and reduce potential crowd incidents. These models were developed to understand and study crowd movements in normal and emergency (evacuation) scenarios using crowd and transport modeling and simulation tools. In particular, modeling and simulation of the integrated Tawaf and Sayee rituals at the Holy Grand Mosque in Makkah city, integrated transport modes at Hajj, and the evacuation from The Grand Mosque and Aljamarat Bridge were undertaken in this thesis.

1.9. Thesis Outline

Following this introduction, Chapter 2 presents a detailed systematic literature review that describes Hajj. This chapter considers crowd modeling and simulation as a planning part of Hajj crowd management to prevent possible crowd disasters in the future. It also discusses how Hajj crowd modelling and simulation have evolved by presenting previous Hajj studies in this area of research. The studies were reviewed and divided into two main themes: Tawaf and Sayee rituals at the Grand Mosque, and crowds at the Aljamarat Bridge. Further, these studies were evaluated by identifying potential applications and how they support the planning and operation of Hajj events.

Chapter 3 focuses on modelling and simulating pilgrims performing Tawaf and Sayee rituals in the Grand Mosque (GM) during Hajj. ExtendSim DES was used to model and simulate integrated rituals in normal and evacuation situations. Scenarios were developed under various crowd conditions to identify crowding and congestion within the Grand Mosque area. In addition, these scenarios were used to identify the effectiveness of changing pilgrim distributions in the GM. The results show that pilgrim groups are distributed according to the quality of the level of service (LoS). Under emergency conditions, evacuation scenarios were developed to identify areas and pathways for evacuation. The results of these evacuation scenarios were compared with those of previous studies.

Chapter 4 describes the features of the new Aljamarat Bridge and the current crowd management plan. This plan includes timetables for the activities, allocating specific routes and levels for pilgrim groups, depending on schedules, and following a unidirectional movement system to prevent counterflows. However, crowd incidents can occur at any time, especially during the emergency evacuation from the bridge. Therefore, this chapter focuses on evaluating the safety of the Stoning the Devil ritual at the Aljamarat Bridge, particularly during the evacuation from the bridge, using the DES tool. Previous studies on modelling and simulation of the Aljamarat Bridge are presented, and their results are compared with the results of our models.

Chapter 5 describes pilgrim' movements between holy sites during Hajj using current transport services comprising conventional buses, shuttle buses, and train and pedestrian routes. The increasing number of pilgrims every year, changes in bus schedules, and inadequate coordination between transport cause congestion

and delays in transport of pilgrims between these sites, affecting overall Hajj rituals. This chapter focuses on modelling and simulating pilgrim transport between holy sites using ExtendSim. Three transport models representing the transport from Makkah to Main on the 8th, Mina and Makkah to Arafat and Arafat to Muzdalifah on the 9th were validated, and scenarios were developed for these models. The scenarios consider changes in the number (percentage) of pilgrims allocated to each transport mode and the scheduling of various modes. The results of these validated models and their scenarios show promising results compared with those of the related works in this chapter. Potential solutions, such as transport managerial strategies to help transport management and fleets, appropriate allocations for each group, planning transport operations before the event and monitoring the use of these resources during the event, are presented.

Finally, the thesis concludes with Chapter 6 by summarising each chapter, the main contributions of the thesis, recommendations, some limitations of the research, lessons learned, and future work. The general findings are that there are reserves of capacity and that scheduling of rituals and transport by TEs, combined with a strict monitoring of the processes and good information and training, can ensure good proceedings of Hajj with an attendance of 3 million pilgrims, reducing costs and improving the participant quality of experience. The modular structure of the models using the same DES ExtendSim allows for integration of all rituals and activities (including transport) with minimal efforts.

References

1. Ahmed, Q. A. and Memish, Z. A. (2016). Hajj 2016: Safeguarding the faithful-Saudi Arabia takes the long view. *Journal of Health Specialties*, 4(4), pp. 227–229.
2. Alabdulkarim, L., Alrajhi, W. and Aloboud, E. (2016) 'Urban analytics in crowd management in the context of Hajj', Lecture Notes in Computer Science (including subseries Lecture Notes in Artificial Intelligence and Lecture Notes in Bioinformatics), 9742, pp. 249–257. doi: 10.1007/978-3-319-39910-2_23.
3. Al-Ahmadi, H. M., Reza, I., Jamal, A., Alhalabi, W. S., and Assi, K. J. (2021). Preparedness for Mass Gatherings: A Simulation-Based Framework for Flow Control and Management Using Crowd Monitoring Data. *Arabian Journal for Science and Engineering*, 46(5), pp. 4985–4997.
4. Alaska, Y. A. *et al.* (2017). The impact of crowd control measures on the occurrence of stampedes during Mass Gatherings: The Hajj experience, *Travel Medicine and Infectious Disease*. Elsevier Ltd, 15, pp. 67–70. doi: 10.1016/j.tmaid.2016.09.002.
5. AlGadhi, S. A. and Still, K. G. (2003), *Jamarat bridge mathematical models, computer simulation and Hajjis safety analysis*, Ministry of Hajj, Jeddah, Saudi Arabia.
6. Alkhadim, M., Gidado, K. and Painting, N. (2018). Risk management: The effect of FIST on perceived safety in crowded large space buildings, *Safety Science*, 108, pp. 29–38. doi: 10.1016/j.ssci.2018.04.021.
7. Al-Kodmany, K. (2013). Crowd management and urban design: New scientific approaches, *Urban Design International*. Nature Publishing Group, 18(4), pp. 282–295. doi: 10.1057/udi.2013.7.

8. Al-Salhie, L., Al-Zuhair, M. and Al-Wabil, A. (2014). Multimedia surveillance in event detection: Crowd analytics in Hajj, *Lecture Notes in Computer Science (including subseries Lecture Notes in Artificial Intelligence and Lecture Notes in Bioinformatics)*, 8518 LNCS (PART 2), pp. 383–392. doi: 10.1007/978-3-319-07626-3_35.
9. Alshalani, H. J., Alnaghaimshi, N. I. and Eljack, S. M. (2020). ICT System for Crowd Management: Hajj as a Case Study, *2020 International Conference on Computing and Information Technology, ICCIT 2020*, 02, pp. 11–15. doi: 10.1109/ICCIT-144147971.2020.9213769.
10. Al-Tawfiq, J. A. *et al.* (2016). Mass gatherings and the spread of respiratory infections lessons from the Hajj, *Annals of the American Thoracic Society*, 13(6), pp. 759–765. doi: 10.1513/AnnalsATS.201511-772FR.
11. Ascoura, I. E. (2013). Impact of pilgrimage (Hajj) on the urban growth of the Mecca. *Journal of Educational and Social Research*, 3(2), pp. 255–255.
12. Babulak, E. and Wang, M. (2010). Discrete Event Simulation: State of the Art, *Discrete Event Simulations*, (March). doi: 10.5772/9894.
13. Basahel, S., Alsabban, A. and Yamin, M. (2021). Hajj and Umrah management during COVID-19, *International Journal of Information Technology (Singapore)*. Springer Singapore, 13(6), pp. 2491–2495. doi: 10.1007/s41870-021-00812-w.
14. Curtis, S. (2013). *Pedestrian velocity obstacles: Pedestrian simulation through reasoning in velocity space*, Doctoral dissertation, The University of North Carolina at Chapel Hill.
15. Dridi, M.H. (2014). Pedestrian flow simulation validation and verification techniques, *arXiv preprint arXiv:1410.0603*.
16. Fayoumi, A., Al-Ghoraibi, S., Fadel, A., Al-Aswadi, F., Mujallid, F. and Wazzan, M. (2011). A simulator to improve the pilgrims' performance in stoning ritual in Hajj, *International Journal of Computer Science and Network Security*, 11(5), pp. 141–144.
17. Felemban, E., Fatani, A. and Rehman, F. U. (2019). An Optimised Scheduling Process for a Large Crowd to Perform Spatio-temporal Movements Safely during Pilgrimage, *Proceedings - 2019 IEEE International Conference on Big Data, Big Data 2019*. IEEE, pp. 6049–6051. doi: 10.1109/BigData47090.2019.9006154.
18. Felemban, E., Rehman, F. U., Biabani, A. A., Naseer, A., and AlAbdulwahab, U. (2019a). Towards building an interactive platform for analysing the movement of buses in Hajj. In *2019 IEEE International Conference on Big Data (Big Data)* (pp. 3775–3778).
19. Felemban, E., Rehman, F. U., Wadood, H., and Naseer, A. (2019b). Towards building evacuation planning platform using multimodal transportation for a large crowd. In *2019 IEEE International Conference on Big Data (Big Data)* (pp. 4063–4066). doi: 10.1109/BigData47090.2019.9006226.
20. Felemban, E.A., Rehman, F.U., Biabani, S.A.A., Ahmad, A., Naseer, A., Majid, A.R.M.A., Hussain, O.K., Qamar, A.M., Falemban, R. and Zanjir, F., (2020). Digital Revolution for Hajj Crowd Management: A Technology Survey, *IEEE Access*, 8, pp. 208583–208609. doi: 10.1109/ACCESS.2020.3037396.
21. Felemban, E., Sheikh, A. A. and Naseer, A. (2021). Improving response time for crowd management in Hajj, *Computers*, 10(4), pp. 1–14. doi: 10.3390/computers10040046.
22. Felemban, E., Ur Rehman, F. (2022). An Interactive Analysis Platform for Bus Movement: A Case Study of One of the World's Largest Annual Gathering. In: *Rodrigues, J.J.P.C., Agarwal, P., Khanna, K. (eds) IoT for Sustainable Smart Cities and Society. Internet of Things*. Springer, Cham. https://doi.org/10.1007/978-3-030-89554-9_6.
23. Fourati, J., Issaoui, B. and Zidi, K. (2017). Literature review of crowd management: A Hajj case study, *ICINCO 2017 - Proceedings of the 14th International Conference on Informatics in Control, Automation and Robotics*, 1(Icinco), pp. 346–351. doi: 10.5220/0006472103460351.
24. Gil, F.A.M. (2014). Reinforcement learning in a multi-agent framework for pedestrian simulation, Doctoral dissertation, *Universitat de València, Escola Tècnica Superior d'Enginyeria*.
25. Haase, K., Kasper, M., Koch, M. and Muller, S. (2019). A pilgrim scheduling approach to increase safety during the Hajj, *Operations Research*, 67(2), pp. 376–406. doi: 10.1287/opre.2018.1798.
26. Hussain, O., Felemban, E. and Ur Rehman, F. (2021). Optimisation of the Mashaer Shuttle-Bus Service in Hajj: Arafat-Muzdalifah Case Study, *Information (Switzerland)*, 12(12), pp. 1–16. doi: 10.3390/INFO12120496.
27. Ijaz, K., Sohail, S. and Hashish, S. (2015). A survey of latest approaches for crowd simulation and modelling using hybrid techniques, In *17th UKSIM-AMSS International Conference on Modelling and Simulation*, pp. 111–116.

28. Illyas, Q. M. (2013). NetLogo Model for Ramy Al-Jamarat in Hajj, *Journal of Basic and Applied Scientific Research*, 3(12), pp. 199–209.
29. Jadrić, M., Ćukušić, M. and Bralić, A., 2014. Comparison of discrete event simulation tools in an academic environment. *Croatian Operational Research Review*, 5(2), pp. 203–219.
30. Kamaruding, M., Alias, M. S., Muis, A. M. R. A., and Mokthar, M. Z. (2020). The Philosophy of Hajj Management. *Jurnal Maw'izah*, 3(1), pp. 67–76.
31. Kassens-Noor, E. (2010). Planning for Peak Demands in Transport Systems—An Agenda for Research. In *Selected Proceedings of the 12th World Conference on Transport Research*. Lisbon: World Conference on Transport Research Society.
32. Krahl, D., Nastasi, A., and Tolk, A. (2014). Reliability modelling with Extendsim. In *Proceedings of the 2014 Winter Simulation Conference* (pp. 4219–4225). Savannah, GA, USA: IEEE.
33. Khan, I (2012). Hajj crowd management: Discovering superior performance with agent-based modelling and queuing theory, University of Manitoba.
34. Khan, I. and McLeod, R. (2012). Managing Hajj crowd complexity: Superior throughput, satisfaction, health, & safety. *Kuwait Chapter of Arabian Journal of Business and Management Review*, 2(4), pp. 45–59.
35. Klüpfel, H. (2007). The simulation of crowd dynamics at very large events—Calibration, empirical data, and validation, In *Pedestrian and Evacuation Dynamics 2005*, Springer Berlin Heidelberg, pp. 285–296.
36. Mahmood, I., Haris, M. and Sarjoughian, H. (2017). Analysing emergency evacuation strategies for mass gatherings using crowd simulation and analysis framework: Hajj scenario, *SIGSIM-PADS 2017 - Proceedings of the 2017 ACM SIGSIM Conference on Principles of Advanced Discrete Simulation*, pp. 231–240. doi: 10.1145/3064911.3064924.
37. Manenti, L., Manzoni, S., Vizzari, G., and Dijkstra, J. (2012). Towards Modeling Activity Scheduling in an Agent-based Model for Pedestrian Dynamics Simulation. In *WOA* (Vol. 892).
38. Memish, Z. A. et al. (2012). The emergence of medicine for mass gatherings: Lessons from the Hajj, *The Lancet Infectious Diseases*, 12(1), pp. 56–65. doi: 10.1016/S1473-3099(11)70337-1.
39. Mohamad, S., Sunar, M. S. and Hanifa, R. M. (2016). A Review on Tawaf Crowd Simulation: State- A Review on Tawaf Crowd Simulation: State-of-the-Art. *International Journal of Interactive Digital Media*, 2(11), pp. 1–6.
40. Mohandes, M. A. (2015). Mobile technology for socio-religious events: a case study of NFC technology. *IEEE Technology and Society Magazine*, 34(1), pp. 73–79.
41. Mokhtary, E. (2017). Pedestrian simulation study of Mecca, accessed on 01/02/2018, <https://www.linkedin.com/pulse/pedestrian-simulation-study-mecca-ehsan-mokhtary>
42. Muneeza, A. and Mustapha, Z. (2021). COVID-19: it's impact in Hajj and Umrah and a future direction, *Journal of Islamic Accounting and Business Research*, 12(5), pp. 661–679. doi: 10.1108/JIABR-02-2021-0062.
43. Namoun, A., Mir, A., Alkhodre, A. B., Tufail, A., Alrehaili, A., Farquad, M., Alwaqdani, A. T. and Benaida, M. (2018). A multi-agent architecture for evacuating pilgrims in panic and emergency situations: The Hajj scenario, *Journal of Theoretical and Applied Information Technology*, 96(20), pp. 6665–6676.
44. Nasir, F. M. and Sunar, M. S. (2016). Simulating large group behaviour in tawaf crowd, *Proceedings - APMediaCast 2016*. IEEE, pp. 42–46. doi: 10.1109/APMediaCast.2016.7878169.
45. Osman, M. and Shaout, A. (2014). Hajj Guide Systems - Past, Present and Future, *The International Journal of Emerging Technology &*, 4(8), pp. 25–31. Available at: <http://citeseerx.ist.psu.edu/viewdoc/download?doi=10.1.1.566.4570&rep=rep1&type=pdf>.
46. Owaidah, A., Olaru, D., Bennamoun, M., Sohel, F. and Khan, N. (2019). Review of Modelling and Simulating Crowds at Mass Gathering Events: Hajj as a Case Study, *Journal of Artificial Societies and Social Simulation*, 22 (2) 9 <<http://jasss.soc.surrey.ac.uk/22/2/9.html>>. doi: 10.18564/jasss.3997.
47. Still, D.K. (2013). Why model crowds, accessed 22/10/2016, <http://www.gkstill.com/Support/WhyModel/index.htm>
48. Quan, K., King, G., and Schrimpf, T. (2015). Discrete event simulation—a tool to support the design of complex production and logistic processes; its application in underground mine design. In *Design Methods 2015: Proceedings of the International Seminar on Design Methods in Underground Mining* (pp. 443–462). Australian Centre for Geomechanics. doi: 10.36487/acg_rep/1511_27_quan.
49. Qurashi, J. (2018). Hajj: the movement and behaviour of crowds, *Risk and safety challenges for religious tourism and events*, pp. 52–62. doi: 10.1079/9781786392282.0052.

52. Rabiaa, C. and Foudil, C. (2016). Toward a Hybrid Approach for Crowd Simulation, *International Journal of Advanced Computer Science and Applications (IJACSA)*, 7(1), pp. 51–61.
53. Reffat, R. (2012). An Intelligent Computational Real-time Virtual Environment Model for Efficient Crowd Management, *International Journal of Transportation Science and Technology*. Tongji University and Tongji University Press, 1(4), pp. 365–378. doi: 10.1260/2046 0430.1.4.365.
54. Ridda, I., Mansoor, S., Briggs, R., Gishe, J., & Aatmn, D. (2021). Preparedness for mass gathering during Hajj and Umrah. *Handbook of healthcare in the Arab World*, 1215-1235.
55. Sehli, M., Sarkar, P., and Young, L. (2016). The Development of E-Hajj: Influence of Diversity Issues. In
56. *Proceeding The Pacific Asia Conference on Information Systems (PACIS)*. 340
57. Sarmady, S., Haron, F. and Talib., A. Z. (2007). Evaluation of existing software for simulating of the crowd at Masjid Al-Haram, *Journal Pengurusan Jabatan Wakaf Zakat & Haji*, 1(1), pp. 83–95.
58. Serova, E. (2013) 'The Role of Agent-Based Modelling in the Design of Management Decision Processes',
59. *The Electronic Journal Information Systems Evaluation*, 16(1), pp. 71–80.
60. Sharma, D., Bhonekar, A.P., Shukla, A.K. and Ghanshyam, C. (2018). A review on technological advancements in crowd management, *Journal of Ambient Intelligence and Humanized Computing*. Springer Berlin Heidelberg, 9(3), pp. 485–495. doi: 10.1007/s12652-016-0432-x.
61. Sharma, P. (2015). Discrete-Event Simulation, *International Journal of Scientific & Technology Research*.
62. 4(4), pp. 136–140.
63. She, J., Chung, W. and Kim, D. (2018) 'Discrete-event simulation of ground-based timber harvesting operations', *Forests*, 9(11), pp. 1–20. doi: 10.3390/f9110683.
64. Shirah, B. H., Zafar, S. H., Alferaidi, O. A. and Sabir A. M. M. (2017). Mass gathering medicine (Hajj Pilgrimage in Saudi Arabia): The clinical pattern of pneumonia among pilgrims during Hajj, *Journal of Infection and Public Health*. King Saud Bin Abdulaziz University for Health Sciences, 10(3), pp. 277–286. doi: 10.1016/j.jiph.2016.04.016.
65. Siddiqui, A. A. and Gwynne, S. M. V. (2012). Employing pedestrian observations in engineering analysis",
66. *Safety Science*, 50(3), pp. 478–493.
67. Sweileh, W. M. (2022). Health-related research publications on religious mass gatherings of Muslims: a bibliometric analysis (1980–2020), *Tropical Diseases, Travel Medicine and Vaccines*. Tropical Diseases, Travel Medicine and Vaccines, 8(1), pp. 1–10. doi: 10.1186/s40794-021-00158.
68. Taibah, H. (2015). Investigating communication and warning channels to enhance crowd management strategies: a study of Hajj pilgrims in Saudi Arabia. The University of North Texas.
69. Taibah H. and Arlikatti S. (2015). An Examination of Evolving Crowd Management Strategies at Pilgrimage Sites: A Case Study of ‘Hajj’ in Saudi Arabia. *International Journal of Mass Emergencies and Disasters*. 33(2), pp. 188–212.
70. The General Authority for Statistics, Kingdom of Saudi Arabia, *Hajj statistics 2012-2019*, accessed on 02/02/2022, [Hajj | General Authority for Statistics \(stats.gov.sa\)](https://stats.gov.sa).
71. Yamin, M. (2019). Managing crowds with technology: cases of Hajj and Kumbh Mela, *International Journal of Information Technology (Singapore)*. Springer Singapore, 11(2), pp. 229–237. doi: 10.1007/s41870-018-0266-1.
72. Yamin, M. and Albugami, M. A. (2014). An architecture for improving Hajj management. In *International Conference on Informatics and Semiotics in Organisations (pp. 187–196)*. Springer, Berlin, Heidelberg.
73. Xu, M. L., Jiang, H., Jin, X. G. and Deng, Z. (2014). Crowd simulation and its applications: Recent advances, *Journal of Computer Science and Technology*, 29(5), pp. 799–811.
74. Zainuddin, Z., Thinakaran, K. and Abu-Sulyman, I.M. (2009). Simulating the circumambulation of the Ka'aba using Simwalk, *European Journal of Scientific Research*, 38(3), pp. 454–464.

Chapter 2

Chapter 2 : Review of Modelling and Simulating Crowds at Mass Gathering Events: Hajj as a Case Study¹

Abstract

The Hajj is an Islamic pilgrimage that involves four main holy sites in Makkah, Saudi Arabia. As the number of participants (pilgrims) attending these events has been increasing over the years, challenges have arisen overcrowding at the sites resulting in congestion, pilgrims getting lost, stampedes, injuries and even deaths. Although Hajj management authorities have employed up-to-date facilities to manage the events (e.g., state-of-the-art infrastructure and communication technologies, CCTV monitoring, live crowd analysis, time scheduling, and large well-trained police forces and scouts), there is still overcrowding and “unexpected” problems that can occur at the events. These problems can be studied and mitigated by prior simulation, which allows for preparation and deployment of the most appropriate plans for crowd management at Hajj events. This chapter presents a comprehensive survey of crowd modelling and simulation studies referring to Hajj.

2.1. Introduction

Mass gathering (MG) events, such as sport (Olympics games and FIFA world cups), musical concerts, religious events and political events (such as procession, rallies and social riots) frequently occur around the world throughout the year (Krausz & Bauckhage 2011; Alshammari & Mikler 2015; Mahmood et al. 2017). An MG event is defined by World Health Organization (WHO), as “any occasion, either organized or spontaneous, that attracts a sufficient number of people to strain the planning and response resources of the community, city or nation hosting the event” (Alshammari & Mikler 2015, p. 574). MG events vary depending on the purpose and the length of the event, number of attendees, location, and whether they are planned or spontaneous. According to Memish et al. (2012), at least 1,000 people must attend the event for it to qualify as an MG. These events present many challenges, such as crowd management, security, and emergency preparedness (Krausz & Bauckhage, 2011).

This chapter focuses on one of the largest MG events in the world, the Hajj, an annual pilgrimage to the city of Makkah, Saudi Arabia, which consists of a set of religious rituals that should be done within a certain

¹ This chapter was published in The Journal of Artificial Societies and Social Simulation

time frame in specific locations (Hajj holy sites) (Seliaman et al. 2001). The Hajj presents enormous challenges for emergency awareness, crowd management and control, and disaster responses to unforeseen natural or human-made threats (Alaska et al. 2017). It is especially difficult for the managing Hajj authorities when all pilgrims complete their rituals at one location and move together, in a short time to the next location (Sowmya & Kumar 2014). Rahman et al. (2017) mention that currently pilgrim numbers exceed 4 million and are expected to increase by 10% every year; many pilgrims are elderly, illiterate and come from developing countries. One of the major issues surrounding this MG event is that Hajj must be completed over a limited and fixed schedule in five days. Hajj rituals are performed as a specific sequence of activities within a geographical area of 400 ha.

The precision and strictness of the rituals result in disasters almost every year, arising from problems such as overcrowding, crowd incidents (lost, injured or dead), medical emergencies, guiding the lost and congestion management (Sowmya & Kumar 2014). In order to face these challenges, Hajj authorities require accurate and real-time estimation of crowds at different locations, to allow intervention before any critical situation occurs (Yaseen et al. 2013). Hajj management also involves monitoring and controlling pilgrims (based on analysis of their movements) and providing early warnings of any unusual behaviours such as a build up at a certain location (Khozium et al. 2012). Although one of the Hajj crowd management goals is to preserve an adequate level of comfort during pilgrims' movements at Hajj holy sites, a commitment to crowd safety is a key element of crowd management to ensure that participants at Hajj are protected in both emergency situations and normal conditions (Al-Nabulsi 2015). Crowd management also involves developing plans and actions from the examination of causes of previous crowd disasters, to prevent them from occurring again.

This chapter summaries previous crowd modelling and simulation studies for Hajj events and their findings through a systematic literature review. Section 2.1 covers the introduction of the research and the motivation for choosing the Hajj event as a case study (the significance of Hajj as an MG event). Section 2.2 describes the framework followed in the literature search. Section 2.3 focuses on describing the event and the holy sites where Hajj is performed. In addition, the significance of Hajj as a mass gathering event, the complexity of Hajj crowd management, the overcrowding challenges and unexpected problems that might occur in future Hajj events are also included (sections 2.4, 2.5 and 2.6). Section 2.7 reviews the work undertaken on crowd modelling and simulation with special attention on the Hajj. This is followed by a

discussion of these studies (Section 2.8), and finally, conclusions are presented (Section 2.9).

2.2. Literature Search Framework

A review of the literature was conducted in accordance with PRISMA guidelines to capture relevant studies modelling Hajj events. The following steps were included (Cablová et al. 2017):

A. Aim of review

The main objective of the review is to analyse and summarise results of studies in crowd modelling and simulation for Hajj events under normal and emergency situations, and therefore identify the main crowd management strategies that could be applied.

B. Included research questions

- How could crowd modelling and simulation of mass gathering events be conducted under normal and emergency (evacuation) situations?
- How could crowd modelling and simulation of mass gathering events provide Hajj crowd management guidance and strategies at Hajj holy sites?
- How could crowd modelling and simulation of mass gathering events be improved by combining both micro and macro level modelling techniques?

C. Identifying data sources

Most of the search was undertaken using the databases of IEEE, Science Direct, Elsevier, ACM Digital Library, Springer Link, Research Gate, Oxford database, JASSS, arXiv and The University of Western Australia database (OneSearch). The search was conducted in October-December 2017. This review also used the Saudi Civil Defense website, which is a Saudi Arabian governmental portal for identifying the main future risks at the Hajj holy sites.

D. The process of selection criteria and data collection

The data collection strategy and the selection criteria in this review chapter focus on two main topics: Hajj as a case study of MG event and models to simulate crowds at this MG event as a solution for managing these crowds. This review includes both academic and grey literature published in English between 2002 and 2018.

Cross-searching was carried out using strings of search terms given in Table 2-1.

E. PRISMA Flow diagram

Figure 2-5 (from the Appendix) presents the criteria for inclusion and exclusion of the papers and the PRISMA Flow. Papers were screened and retained if they were: (a) peer-reviewed; (b) accessible in full text form; and (c) specifically presenting a modelling approach, not only presenting the Hajj events. Table 2-5 (Appendix) presents the final studies selected for this literature review, including their keywords and their compliance with the selection criteria. Duplications were removed, and abstracts and papers were eliminated if they were not eligible (e.g., medical studies focusing primarily on epidemiological aspects).

F. PRISMA Check list: available in Table 2-6 (from the Appendix)

Table 2-1: Keywords for the analytic search of the literature. Note: Both US and UK/Australian spelling were considered in the search.

Hajj	Crowd modelling and simulation for Hajj events	Modelling and simulation
<ul style="list-style-type: none"> • Hajj as an MG event • Crowd management at Hajj • Hajj management complexity • Crowd behaviours at Hajj • Hajj holy site — The Grand Mosque OR Arafat OR Mina City OR Aljamarat Bridge OR Muzdalifah OR Tawaf OR Sayee • Stoning the devil • Movement from Arafat to Muzdalifah • Hajj challenges • Overcrowding at Hajj event • Crowd incidents during Hajj • Future issues on Hajj crowd management 	<ul style="list-style-type: none"> • Crowd modelling • Crowd simulation • Types for crowd modelling and simulation • Agent-based modelling • Cellular Automata modelling • Social force modelling • Crowd modelling and simulation for Hajj event • Crowd modelling and simulation for normal situations at Hajj event • Crowd modelling and simulation for emergency situation (evacuation) at Hajj 	<p>Significance of modelling and simulation</p>

2.3. Hajj as a Case Study

Hajj is considered to be the biggest annual mass gathering event in the world (Al-Nabulsi 2015). This pilgrimage is a set of rituals conducted over five days starting from the ninth and ending on of the thirteenth day of the month of Dull Hijjah in the Muslim lunar calendar (Kurdi 2017). Hajj is one of the obligatory five pillars of Islam, and is a duty that the physically able, healthy, and financially able are required to perform once in a life- time (Memish et al. 2014). A myriad of studies have been conducted on Hajj from different research

viewpoints. For example, Kurdi (2017) highlighted that research on Hajj should focus on the safety and quality of pilgrims' experiences. There are several other research studies related to particular Hajj events, for example Tawaf and Sayee rituals, the Aljamarat Bridge ritual, pilgrims' movements between the Hajj ritual places (Arafat, Muzdali-fah and Mina city), accommodations at these places, medical issues and Hajj security (Khan 2012). Developing Hajj research projects is critical for several reasons (Kurdi 2017), but many were developed in response to the many injuries and fatalities of pilgrims that have occurred over the last two decades due to uncontrolled crowd movement at the Tawaf and Aljamarat area. As the number of pilgrims has been increasing, existing facilities at Hajj sites get even more congested due to overcrowding.

Alaska et al. (2017) have outlined Hajj is considered as a unique MG event due to both its size, but also to the heterogeneity of the crowd. Each country that might be represented has limited attendance allocations (country quota) and as a result, the majority of pilgrims have to wait for a long time before they leave for Hajj. This process leads to a majority of older pilgrims performing Hajj rituals in extreme environmental conditions (the temperature often exceeds 37 degree Celsius) and moving in large groups at overcrowded locations.

2.3.1 Hajj Holy Site

The Hajj rituals are performed at The Grand Mosque (Al-Masjid Al-Haram) and holy sites. These sites include three separate areas (see Figure 2-1) These are Arafat (approximately 20 km from the Grand Mosque), Muzdalifah (approximately 13 km from the Grand Mosque) and Mina (approximately 6 km from the Grand Mosque). Pilgrims move between Hajj ritual sites by walking, or using dedicated public transport (buses or trains). More than 20,000 buses are used to transport pilgrims between these sites, while trains transport 72,000 pilgrims per hour (Al-Nabulsi 2015).



Figure 2-1: Hajj holy sites, Makkah City (using Google Maps)

2.3.1.1. The Grand Mosque (Almasjid Al-Haram)

The Grand Mosque (Al-Masjid Al-Haram) covers an area of 35.68 ha and includes outdoor and indoor prayer spaces (Rahman et al. 2017). The total capacity of these spaces is about 2 million. When Al-Masjid Al-Haram is completely occupied, it accommodates an average crowd density level of 4 people/m². However, there are specific locations, such as around the Ka'bah, where the crowd density reaches 6-8 people/m².

Al-Masjid Al-Haram has had a number of extensions as a response to the spatial needs of the increasing numbers of pilgrims (Tunasar 2013). Any further expansion has to deal with spatial, architectural, structural, historical, and managerial boundaries. Pedestrian counts and statistics indicate that the number of people inside and outside Al-Masjid Al-Haram (plazas) reaches 366,000 pilgrims at peak time (Shalaby et al. 2013). These people need to exit the space after an hour, as a similar number of people will enter for the next hour.

2.3.1.2. Mina City

The site of Mina consists of city tents and Aljamarat Bridge. In 1995, the Saudi government built 100,000 tents, to provide temporary accommodation for millions of pilgrims (Al-Nabulsi 2015).

2.3.1.3. Arafat

The holy site of Arafat is one of the important sites of Hajj. Edrees (2012b) described Arafat as a 1,269 ha area, of which almost half (44% = 558.36 ha) is built up with the remaining (56% = 710.64 ha) representing roads and pedestrian routes. Arafat becomes the most crowded site on the second day of Hajj, because all pilgrims have to arrive, spend half the day and leave after sunset. This poses overcrowding problems at the nine main roads of access to and from Arafat and at Arafat railway stations.

After sunset, all pilgrims leave Arafat for Muzdalifah, which is about 7-8 km to the west. Both of these sites are linked via nine roads for vehicles and two roads for pedestrians. It is estimated that peak pedestrian flow rate between Arafat and Muzdalifah is approximately 500,000 pilgrims per hour (Abdelghany et al. 2012).

2.3.1.4. Muzdalifah

The site of Muzdalifah is an open area of about 1,000 ha, located halfway between Arafat and Mina (Centre of Research Excellence in Hajj and Omrah CORE, 2010). After spending the day at the Arafat, pilgrims move to spend their night at Muzdalifah for the “Al-Nafrah”. This mass movement of more than 2 million pilgrims takes place on buses, trains or by foot. While they are at this holy site, pilgrims collect pebbles for the following days rituals (Seliaman et al. 2001).

2.3.1.5. Aljamarat Bridge

Edrees (2012a) describes Aljamarat Bridge as the heart and the bottleneck of Mina city (Figure 2.2). It has two main pedestrian routes to enter the bridge. The bridge consists of three main pillars, where pilgrims perform the ritual of stoning the devil. These pillars are the most crowded places at the bridge. The peak times at the bridge are on Day 3 (10th of Dul-Hijjah) from dawn till noon, on Day 4 (11th) afternoon and evening and on Day 5 (12th) afternoon. Aljamarat Bridge is additionally considered as a gateway for pilgrims heading to Makkah city to perform Tawaf ritual at the Grand Mosque (Al-Nabulsi 2009).

After the stampede of 2006, the Kingdom of Saudi Arabia government reconstructed Aljamarat Bridge (as shown in Figure 2-2) to prevent crowding and recurrent accidents, completing the project in 2010. At peak

times, the density of crowd currently reaches 300,000 pilgrims per hour (Alaska et al. 2017). Features of the new bridge are as follows (Imam & Alamoudi 2014):

- 950m long and 80m wide (the previous width was 40m);
- Multi-level (ground, first, second, third and fourth);
- 11 entries and 12 exits;
- 20 hectares surface;
- Integral cooling system (maximum temperature inside the bridge is capped at 29);
- Many distributed CCTV cameras that transmit live videos to the control rooms;
- Unidirectional, to prevent counter flows.



Figure 2-2: Aljamarat Bridge. Source: Edrees (2016).

2.3.2. Hajj Rituals

Several papers have presented features of the individual Hajj events. For example, Zawbaa & Aly (2012) briefly described the Hajj holy sites and their rituals over the five days (8th to the 12th of the Dull Hijjah). Here we summarise them (Table 2-2) and explain the main challenges at each site.

Table 2-2: Hajj rituals, their dates and challenges

Hajj Ritual activity	Challenges
<u>Tawaf on the 8th of Dull Hijjah:</u> The first ritual to perform when pilgrims arrive to Makkah city for Hajj events. They circumambulate the Ka'bah seven times anticlockwise.	The Mataf (Tawaf area) is surrounded by a two-storey building, which accommodates 330,000 pilgrims, and creates overcrowding problem (Abdelghany et al., 2016).
<u>Sayee on the 8th of Dull Hijjah:</u> This ritual requires walking back and forth between Safa and Marwah hills seven times	The Sayee is a multi-storey area with two-way routes between Al-Safa and Al-Marwah mountains. This area is about 390m long and 33m wide. The crowd density in this area could reach 50,000 people with about 4-8 persons/m ² which creates overcrowding problems (Abdelghany et al., 2016).
<u>Staying in Mina on the 8th, 10th, 11th, 12th, (sometimes on 13th):</u> Pilgrims spend most of their days at Mina city	Getting lost is expected at Tents City in Mina, as all these tents are white and look the same.
<u>Standing on the Mount of Arafat on the 9th of Dull Hijjah:</u> The significant Hajj ritual, where all pilgrims must spend the second day at Arafat.	Many pilgrims spend most of their daytime on top of this mountain. Therefore, this mountain is considered one of the most crowded places of Hajj event, creating conditions for many injuries and lost pilgrim cases. Specifically, Edrees (2012) noted the most crowded places at Arafat are: Alrahmah Mountain, Alnamirah Mosque, the pedestrian routes between the mountain and the mosque, the Arafat railway stations, and the exit gates from Arafat area.
<u>Staying at Muzdalifah on the 9th of Dull Hijjah:</u> After the ritual of Arafat, all pilgrims must leave and spend the night in Muzdalifah before the sunrise of the next day.	It is estimated that peak pilgrim flow rate is 500,000 per hour from Arafat to Muzdalifah (Abdelghany et al., 2012). Therefore, crowd incidents (e.g., getting lost) are common during this movement.
<u>Stoning the devil on the 10th, 11th, 12th, (some cases on the 13th):</u> Throwing stones at the pillars inside Aljamarat Bridge, except stoning the bigger pillar, which is on the 10 th day.	Crowd incidents (e.g., getting lost) are expected in this area.

2.4. The Significance of Hajj event

The study of Owaidah (2015) described Hajj as a unique event for several reasons. First, Hajj represents one of the largest annual events globally, which attracts millions of pilgrims from more than 184 countries (Rahman et al. 2017) within specific areas and for a limited period of time. This exceeds the scale of the mass gathering events for sports events, festivals, or concerts (Krausz & Bauckhage 2011; Turriss et al. 2014). Movements between the locations of Hajj ritual places (Arafat, Mina and Muzdalifah) adds to this unique profile. This is in contrast with most of the MG events (sporting or concerts) which, except for access and egress to the venue, are static (Krausz & Bauckhage 2011).

Second, the Hajj has witnessed many serious crowd incidents. Between 1994 and 2006, there were five major incidents, which led to 1,053 deaths and 1,295 injuries. Also, the Hajj brings together people from diverse cultures, language and countries (e.g., Indonesia, Pakistan, India, Turkey, Iran, Nigeria, Bangladesh, Egypt, Euro-pean countries, USA, Russia and China). This impacts crowd management for pilgrims, as well as their response to any potential dangerous hazards. In addition, this cultural diversity dictates how the

pilgrims perform the practices, depending on the individual's Islamic doctrine, and this potentially complicates the management of pilgrim movements between the holy places.

A useful classification of the features of MG events was provided by Turrís et al. (2014) and presented in Table 2-7, Appendix. As already highlighted, the multi-site, dynamic nature of the Hajj, combined with its sheer size and socio-demographics, make Hajj an exceptionally intricate case that requires special investigation and specific solutions. Felemban & Basalamah (2011) describe additional characteristics, beyond wide national, social, cultural and educational diversity of participants that make Hajj so distinctive. Foreign pilgrims are 45 years of age or older, and as Hajj is performed once in a lifetime, this can create unexpected emotions and behaviours.

2.5. Complexity of Crowd Management for MG Events

Because of their increasing popularity and higher rates/frequencies, safety measures for MG events are central issues on the agenda of MG organizers, to eliminate the likelihood of crowd disasters. Incidents may occur when the crowd densities become extremely high (Krausz & Bauckhage 2011), reaching up to 10 people/m² and the solution is to keep flows separated (both in space and time) (Johansson et al. 2012). At high densities, 'stop- and-go' waves or crowd 'turbulences' may occur and eventually could cause stampedes (Krausz & Bauckhage 2011; Johansson et al. 2012).

In the past decade, the use of scheduling, crowd control, luggage management, video monitoring, and changes in the transport system for the event, have been implemented as solutions for crowd management at various events. In addition, work towards the prevention of crowd disasters included simulations of human behaviour in crowds. Using such simulations, one can identify and defuse situations potentially dangerous in any environment where crowds are present (Johansson et al. 2012).

2.5.1. Crowd management at Hajj

Khan (2012) identifies Hajj management as the set of decisions to plan, organise and control every activity associated with Hajj events and with the rituals. These decisions are expected to lead to superior crowd performance considering safety, satisfaction and health conditions.

Al-Nabulsi (2015) emphasised that the preparation of Hajj crowd management is a complex task, taking about 12 months to organize for the next Hajj. During this period, extensive planning is prepared by the Hajj governmental agencies for supporting all Hajj sectors to carry out these plans during Hajj and to address major problems that could occur. Managing large crowds, whether pilgrims are performing rituals or moving between Hajj sites, is a daunting task for Hajj organizers (Osman & Shaout 2014; Reda 2016). As Hajj rituals combine two types of crowd dynamics, low-density unmotivated movements and high-density movements (Yaseen et al. 2013), it is essential to understand these processes through the analysis of pedestrian movements in massed locations, depending on varying circumstances (Aljohani 2015). In addition, analysis on overcrowding is critical for preventing people from being trampled or crushed.

2.5.2 Overcrowding at Hajj Holy Sties

Given the obligatory performance of specific rituals at specific times at specific locations (Reda 2016), large numbers of pilgrims move and gather while performing Hajj rituals, potentially causing bottlenecks. Potential resulting overcrowding can lead to stampedes, traffic and human jams, counter flows, stop-and-go waves, crowd turbulence, and panic (Friberg & Hjelm 2015). All these consequences appear to be unavoidable despite many interventions with positive effects (expansions, careful planning of Hajj events). Thousands of people who have participated in crowded religious events have faced these problems while performing their activities (Yamin 2015). A brief description of each of these potential effects follows.

Stampede is a collective rush of individuals in either unified or random directions (Friberg & Hjelm 2015). Human stampedes are the most common hazard to be seen at mass gathering events. They are characterised by massive flow of individuals in a crowd in response to a perceived danger. Stampedes could result in death due to trampling or suffocation under the high pressure caused by the push in the crowd (Owaidah 2015).

‘Stop-and-go waves’ occur when the density of pilgrims is high, and the speed of pilgrims’ movement is slow (Friberg & Hjelm 2015). The flow of pilgrims could last more than 20 minutes, and pilgrims start to move in all directions which can result in pushing and falling (Owaidah 2015).

However, when the density of the pilgrim movement becomes larger than stop-and-go waves (crowd density and speed are both high), crowd turbulence is produced (Friberg & Hjelm 2015). A bottleneck is

created when the natural flow of the crowd cannot continue due to obstacles (Friberg & Hjelm 2015). The flow of bottlenecks differ depending on the width and length of the flow; longer and narrower flows are slower (Friberg & Hjelm 2015).

Panic “. . . refer to situations in which individuals have limited information and vision (due to high crowd density and short time of egress), and which result in physical competition and pushing behaviour” (Shiwakoti & Sarvi 2013, p. 12, Owaidah 2015, p. 20). In addition, it could be defined as the breakdown of order when individuals may start anxious reactions in response to a certain event (Helbing & Johansson 2011; Owaidah 2015). In panic situations, many people attempt to escape from the threat, struggling for survival, which could end up crushing individuals in a crowd. Panic effects displayed in crowded locations could include: individuals move faster than normal; there are physical interactions between individuals (e.g. people start to push each other) or disorganized movements; there is build-up of panicked individuals and alternative routes or exits are unnoticed or are used inefficiently (Office 2009; Owaidah 2015). Therefore, overcrowding and bad management at crowded areas lead to panic followed by injuries and crowd disasters (Halabi 2006, p. 28, Owaidah 2015). However, panic could be preventable using effective crowd management as a part of emergency planning (Drury et al. 2013; Owaidah 2015).

There are additional issues which increase the overcrowding problems at Tawaf area inside the Grand Mosque (Shuaibu et al. 2015): a) pilgrims who finished their Tawaf ritual are always close to Ka’aba. After they complete their ritual, they proceed in a pattern that forces them to collide with other pilgrims; b) congestion and blockage are due to the queuing at the Ka’ba gate and the ‘Black Stone’; c) the entrance to the Tawaf area is not restricted to certain gates and pilgrims easily flow into the area through different directions, although physical constraints are the main challenges. Finally, traffic and human congestion can result in blocking the Hajj main roads for hours. Providing extra lanes to existing road infrastructure can ease congestion problems (Yamin 2015).

In conclusion, overcrowding and panic at religious sites can be contained, and crowd incidents could be prevented by efficient crowd management including sufficient prior planning, infrastructure improvements, deployment of more security officers and information technology improvements (Taibah and Arlikatti, 2015).

Moreover, understanding the role of the pilgrims themselves, such as their movements and behaviours, should be included in the crowd management process for training and education (Taibah and Arlikatti, 2015).

2.6. Previous Hajj crowd incidents and their main causes

Numerous crowd incidents have occurred in the past two decades at Hajj events. These incidents varied by location (at Haram area and Hajj ritual sites, specifically Mina city) and causes, and are presented below.

2.6.1. Incidents at the Grand Mosque

Evidence from Table 2-8 (Appendix) shows that many of these crowd incidents were caused by human fault, with a range of different consequences. A tragic crane incident in 2015 led to 107 deaths and 200 injuries. However, minor incidents at Haram, such as getting lost (in large numbers in 2006, 2011 and 2013), occur recurrently. Due to the crowdedness of Haram area, incidents may occur in the future, which could lead to stampedes, congestion and exhaustion (Edrees 2016).

2.6.2. Incidents at Aljamarat Bridge, Mina

Table 2-9 (Appendix) shows most of the crowd incidents were at Aljamarat Bridge, Mina City, during the ritual of 'stoning the devil'. Edrees (2012a) identified the Aljamarat Bridge as the bottleneck of Mina. In the past, the Bridge had two main pedestrian routes for entry, from Muzdalifah and Almuasim. A stampede at the bridge in 2006 led to 1,035 deaths and 721 injuries (Helbing et al. 2007). The Office (2009) described the reasons for the 2006 disaster as overcrowding, enormous crowd pressures, lack of crowd management at the bridge and pushing forwards too quickly to perform the stoning ritual. Some pilgrims also insist on performing the stoning ritual on the right of the pillars, which could cause crowding around these pillars. The new infrastructure has alleviated this risk, and these incidents decreased radically since.

A stampede caused crowd incidents at Tents City in 2015. This incident was at the crossing of streets 204 and 223 (Khan & Noji 2016). These numbers show the 'unpredictability' of crowd incidents in Hajj, their impact, and that it is critical to prepare for these unexpected events (Aljohani 2015). All of these could be achieved by simulation.

2.6.3. Incidents at Arafat and Muzdalifah

Table 2-10 (Appendix) shows no casualties at Arafat or Muzdalifah. However, cases of lost people have occurred at these places. For example, in 2011, a total of 30,000 pilgrims were lost at Haram and Hajj holy sites (Amro & Nijem 2012). Edrees (2012b) explained some reasons for incidents in these areas: pilgrims insisting on approaching, climbing and standing on Alrahmah Mountain; pilgrims insisting on praying at Alnamirah Mosque at Arafat; exits from Alnamirah mosque and Arafat streets being joined which caused aggregation of pilgrims; pilgrims laying down on Arafat streets and paths; some pilgrims waiting at exit paths early to leave Arafat and head to Muzdalifah; traffic jams occurring at Muzdalifah after pilgrims leave Arafat; and lack of guidance and information distributed to pilgrims.

2.6.4. Observations on past incidents

The Defence (2017) has drawn attention to a number of past incidents and indicated future issues which may present at Hajj holy sites. Past observations include: construction incidents; walking/crossing traffic (not using pedestrian pathways); walking through emergency pathways; resting at the pedestrian pathways; lack of awareness about Hajj sites emergency exits (evacuation precautions); problematic crowd behaviours inside pedestrian tunnels; and falling rocks while climbing Al-Rahmah Mountain (Arafat).

Jbira & Lakhoua (2012) offered insight into why future stampedes, congestion and crowd panic at Aljamarat Bridge might occur. For example, new pilgrims may find it difficult to recognise the ground floor entrance due to the crowds. There is also a general lack of understanding of instructions provided, and there are not enough tools or methods to alert event organisers to the problem before complications occur. Therefore, crowd modelling by simulating crowd scenarios under different situations could help in planning better crowd management and control strategies (Sharma et al. 2018).

2.7. Literature Survey Results

2.7.1. Crowd modelling and simulation Types

Bakar et al. (2017, p. 1) identified modelling as “. . . a method of solving problems, in which the approach under investigation is controlled by a basic pro-test that illustrates the genuine framework and/or its

operation". They identified simulation as " . . . a decision support tool to predict the system behaviour by answering the 'what-if scenarios' ". In addition, crowd simulation is the process of replicating the movement of large numbers of entities, characters, agents or pedestrians. It represents the motion and behaviours of the crowd either via two- dimensional (2D) or three-dimensional (3D) computer graphics (Nasir & Sunar 2016).

Crowd simulation models can be used to predict crowd behaviours and movements and performance issues related to infrastructure (buildings and public facilities) designs (Sarmady et al. 2010). These models could also be used to estimate evacuation time in emergency situations.

Many modelling and simulation methods for pedestrian crowds have been proposed. They can be categorised into two broad categories: (a) Microscopic models, dealing with individual pedestrians, or (b) Macroscopic models, dealing with aggregate characteristics of the crowds (Rahman et al. 2017). They are presented in the following subsections.

2.7.1.1. Agent-Based Models (ABM)

ABMs are microscopic models focusing on the interaction among heterogeneous agents, each with their own set of characteristics/endowments and following their rules of interaction, according to their objectives (Bonabeau 2002). Given that agents are autonomous, responsive, proactive and social, the macro-level outcomes cannot be directly predicted, but they rather emerge from the interactions.

2.7.1.2. Social Force Models (SFM)

SFMs are widely used to model human pedestrians (Bakar et al. 2017). These models are suitable to imitate human behaviours and can generate collective behaviour of pedestrian flow, as individuals follow others. These models can produce smooth movements, accurate and realistic results (Sarmady et al. 2010).

2.7.1.3. Cellular Automata (CA) models

CA uses 'cells' occupied by agents (Bakar et al. 2017). These models examine the movement of agents from one cell to another empty cell. Sarmady et al. (2010) describe CA models as using simple and flexible transition rules to identify the cell to which an agent will move next. CA models for crowd applications divide the

movement space into big grid cells, each cell accommodating an agent. During simulation, agents stay in the current cell or move into one of the neighbouring cells. One of the limitations of the CA setup is the similar speed of the agents in the cells and the identical size of the cells. In real life, pedestrians have different movement speeds and the space they occupy during rituals also differs.

Regarding crowd modelling and simulation for Hajj events, Hajj crowd management and evacuation procedures during both normal and emergency situations justify significant attention, given their recurrent nature (Mohamad et al. 2014). Modelling and simulation are therefore important, as they are tools that can be used to assess safety and take appropriate precautions. Reda (2016) concluded that in order to manage crowd movements efficiently at Hajj events, crowd behaviours, dynamics, formation causes, and formation patterns should be better understood. Crowd modelling and simulation offer opportunities for studying and analysing crowd behaviours and crowd dynamics, in order to predict crowd movements. In addition, Alaska et al. (2017) mentioned that using crowd simulation models helps to assess the best methods of grouping and scheduling pilgrims, managing and controlling crowds and luggage management, as well as informing pilgrims of changes in the transport system used during the event.

2.7.2. Significance of Crowd Modelling and Simulation

Computer modelling and simulation can be used to inform and optimise decision-making for implementing change in real-life scenarios (Tayan 2010). In regard to crowd events, computational techniques are needed for observing behaviour in dense crowds, such as trampling, falling, collision, or pushing (Kurdi et al. 2015). This is particularly relevant for optimising the movements and flow of pilgrims between the holy ritual places at the Hajj events. Simulation models are ‘dynamic’ and allow unpredictable behaviours to appear: “Goal of the simulation is to reproduce realistic scenarios of such situations evolving in real-time involving a large number of virtual human agents” (Ulicny & Thalmann 2001, p. 163, Office 2009, p. 193). Crowd simulation of different scenarios could help in achieving better crowd management and control strategies (Sharma et al. 2018).

Kabalan (2016) highlighted several reasons for using crowd dynamics simulation: help to devise measures aimed at increasing the level of comfort of pedestrians; suggest detail planning for pedestrian paths;

and manage crowds to ensure a safe environment for a large number of pilgrims. Crowd evacuation in emergencies (in a short time and under stress conditions) could be improved. In addition, simulation could help to understand the principles and mechanisms of collective motion and self-organisation phenomena such as shock waves, oscillation at bottlenecks and lane formation.

2.7.3. Previous Hajj Simulation Studies

Computer simulation is a fitting tool to investigate crowd movements and evacuation processes (Kabalan 2016). Due to several overcrowding incidents at Hajj, efforts have been made to address these processes by using crowd simulation models (Johansson et al. 2012). Sharma et al. (2018) showed that data collection (such as video records and traffic counts) enables validation of crowd simulation of Hajj events, offering suggestions for changes in event management and control, and event execution and infrastructure. This literature review focuses on two groups of Hajj studies that simulate rituals at two main locations; Tawaf in the Grand Mosque, and Jamarat at Aljamarat Bridge.

2.7.3.1. Simulating Crowds During Tawaf and Sayee Rituals

Crowd simulation for Tawaf and Sayee rituals uses complex flows of motions, variable velocities, high density and heterogeneous (varieties) populations (Kurdi et al. 2015). In addition, there are significant factors that most of the previous studies focused on, such as the Tawaf (circumambulating the Kaaba) area, pilgrim behaviours and the crowd size (Kurdi et al. 2015). Regardless of the modelling approach, many earlier studies had a common limitation which can now be overcome: the inability to capture the scale of real events. Most models used ABM, SFM and CA approaches.

Mulyana & Gunawan (2010) simulated pilgrims performing Tawaf as 'intelligent' agents, able to recognise the environment and to undertake various actions. Agents' behaviours were depicted to reflect pilgrims' behaviours in real situations. Each agent needs to know the individual current location to determine appropriate behaviour and do specific activities according to the environment. For example, during Tawaf ritual, each agent circles the Ka'bah in an anticlockwise direction, to avoid collisions at crowded places in the Tawaf area, such as gathering around the Black Stone (Al-Hajar Al-Aswad), Maqam Ibrahim and Hijr Ismail.

The objective of Mulyana and Gunawan's (2010) work was to develop Hajj crowd simulation based on agents able to recognise the environment and perform natural and complex behaviours. The results of this type of simulation were superior, demonstrating more realistic behaviour for Tawaf ritual (Kurdi 2017). This simulation can be used for training pilgrims before they perform the ritual. However, the limitation of this study is that the number of agents to be simulated was low; also, some optimisation in this model can be applied, such as using better collision detection in the crowded places.

Khan & McLeod (2012) developed an ABM to investigate the effect of Al-Masjid Al-Haram courtyard layout on pilgrims' movements during Tawaf, to analyse pilgrims' crowd properties (features) and provide a tool for the Hajj authorities to manage crowds, maximise the safety of pilgrims (lack of collisions) and protect their health (against spread of disease). They developed the TawafSIM micro-level simulator, which models pilgrims performing the Tawaf ritual, to explore the impact of crowd characteristics and management preferences on Tawaf performance with respect to pilgrims' satisfaction, health and safety. The authors simulated 42 scenarios in 12 different categories, using colours to indicate the congestion at the Mataf area (Figure 2-3, colours denote their spiralling status). Red dots indicate that pilgrims are spiralling inward from the edge of the crowd boundary to the external half of the circles. Green dots represent maintaining the radius at circles near the Ka'bah whereas blue dots are for pilgrims who are spiralling outwards. Black dots are for pilgrims who have completed the seven rounds and are spiralling outwards to exit from the crowds. The 5th category, yellow, which is dispersed throughout the crowd, represents agents who change their route in order to avoid crowd collisions.

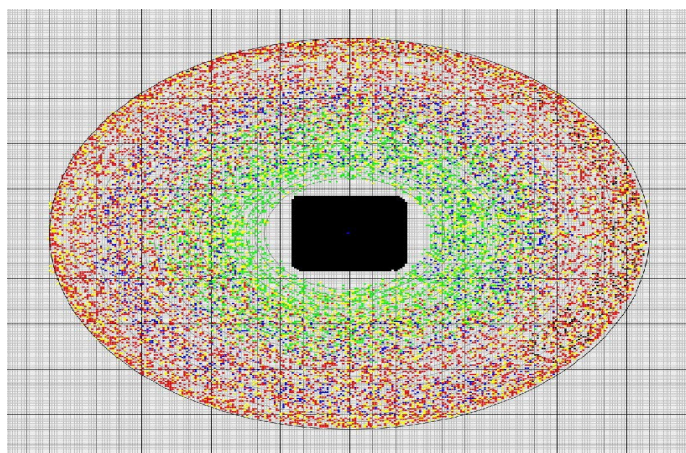

Figure 2-3: Snapshot of TawafSim simulator. Source: Khan & McLeod (2012).

Khan & McLeod (2012) combined ABM with Finite State Machine (FSM), which uses a geometric collision avoidance algorithm. The FSM algorithm was used to model each pilgrim (agent) and to control agents activities when interacting with other agents. Kurdi (2017) mentioned that although this study provides many recommendations regarding crowd management, crowd behaviour and facility layout for safety and throughput, it could be enhanced by using an appropriate crowd simulator with the ability to simulate large numbers of pilgrims and to develop behaviour metrics. This study could be also applied for the crowd management of Tawaf ritual on the other two levels, and the Sayee area of Al-Masjid Al-Haram.

Kim et al. (2015) modelled the physical interactions between agents by using an interactive velocity-based multi-agent framework relying on the agents' ability to anticipate and avoid collisions. This framework was able to model complex behaviour relating to social and cultural rules. The authors used FSM to define a series of behaviours and parameters for their physical interaction model. The work simulated 35,000 agents in dense scenarios (8 agents/m²). As a result, this work was able to simulate complex interaction between agents and dynamic obstacles in the environment, generating many emergent behaviours. Che et al. (2015) mentioned that this study combined velocity-based and avoidance algorithms with FDM to model both physical forces and interactions between the agents and obstacles. Additionally, it allowed agents to anticipate and avoid collisions during local navigations: e.g., pilgrims performing Tawaf at Mataf area while avoiding each other and avoiding colliding with Hijr Ismail or Maqam Ibrahim. However, they modelled a small number of agents, compared to the number of pilgrims during Hajj.

Sarmady et al. (2008) proposed a CA model to simulate pilgrims performing Tawaf rituals. They pointed out that most of the previous systems were unable to simulate pilgrims' movements in Tawaf area with enough agents. Therefore, their proposed model was developed to simulate large crowds of pilgrims and combined a macroscopic model for the crowd movement with CA to simulate collision avoidance and to identify the shortest paths. Their integrated system was capable of simulating between 20,000 to 23,000 agents in real time. In addition, they compared the velocity of the crowds obtained from empirical observations and simulation snapshots with photos taken from the Tawaf area to validate their model. This study was mainly focused on simulating a large number of pilgrims moving at the Mata area (Mohamad et al. 2014) however, their system

failed to consider behaviour such as pushing, falling and grouping (Mohamad et al. 2014).

Siddiqui & Gwynne (2012) used a crowd simulation model known as EXODUS to simulate pilgrims performing the Sayee ritual at the Grand Mosque (Almasjid Alharam). Their model was used to understand individual behaviour when simulating large crowds in emergency situations. This study focused on analysing both pedestrian and evacuee behaviour and used observations by the lead author during his own pilgrimage in 2008 (notes, video footages and still photographs) to calibrate the model. These observations recorded the pilgrims' actions along with the surrounding influential factors and the resulting emergent conditions. The authors decided to use EXODUS due to its ability to produce a range of outputs that allow performance to be examined at the individual, group or population level. Three scenarios were examined: Scenario 1 used the model's default movement parameters with travel speed ranges between 1.2 and 1.5 m/s; Scenario 2 used modified movement parameters to reflect the observed travel speed around 1.0 m/s; and Scenario 3 was similar to scenario 2, but included a subset of the procedural activities, to reflect the individual actions. Two sets of simulations were conducted for each scenario. In the first set (Case A), an individual pilgrim was simulated performing Sayee 3.5 times. In the second set (Case B), a representative population of 15,000 pilgrims was simulated. The individual routes were affected by the introduction of individual task itineraries and producing more complex and vibrated behaviours (Case A), while in Case B, the more complex routes were combined to produce emergent behaviours similar to those observed in the real events. Therefore, this model showed the relationship between pilgrims (agents) and the levels of congested areas from different observations from the Tawaf ritual (Shuaibu et al. 2015). This model was used for prior planning of crowded events, examining all possible and anticipated scenarios for managing crowds in normal and dangerous situations. This process could also be conducted for any crowded places outside Al-Masjid Al-Haram.

Zainuddin et al. (2009) simulated the circumambulation of Ka'bah using the crowd simulation model SimWalk. The authors underlined two main problems in the Tawaf area. First was the large number of pilgrims in this area, which causes pilgrims to push each other. Second, the area has unlimited bi-directional entries, which result in pilgrims entering and exiting at the same time and causing congestion. Therefore, this study suggested various mitigation measures to ease the pilgrim flows in the Tawaf area: building a spiral path, encircling the Ka'bah venue seven times, but with the path entrance at the outermost fold, and the completion

of the Tawaf at the innermost fold, leading to an underground tunnel; and waiting points around the Ka'ba, which can direct pilgrims to walk around the Ka'ba without building congestion. The results of this study showed that building the spiral path is an effective solution in ensuring smooth crowd flows in the Tawaf area. However, the authors mentioned that this approach might not be realistic to implement, as the underground tunnel involves additional costs and may be infeasible (historical items located below the Tawaf area). As a result, an alternative approach was building an overhead bridge that links the centre of the Tawaf area to the exit of the Grand Mosque. The main drawback of this study is simulating only 1,000 pilgrims, which is insignificant compared to the real number of pilgrims (300,000) in Tawaf ritual during Hajj.

Dridi (2014) used PedFlow to simulate pilgrims performing rituals in the Tawaf and Sayee areas. The model was verified and validated using data collected during Hajj 2009 and included walking time and the number of pilgrims and crowd density at the Grand Mosque gates before and after each prayer. The following methods were applied: 1) Comparisons of PedFlow results with video recordings of Hajj 2009; 2) Comparisons between PedFlow results and other simulation models results, such as Simulex/Myriad. The Pedflow results were more sophisticated in predicting the high density of crowd and crowd dynamics; 3) Sensitivity analysis showing the effect of different input values on the simulation outputs. Dridi (2014) concluded that PedFlow can produce realistic crowd motion with agents moving at different speeds and under different situations using avoidance action (collisions). However, this model should be tested again with new updated data of crowds at Mataf area and Sayee area at Al-Masjid Al-Haram or other locations.

Nasir & Sunar (2016) presented a study to simulate group behaviour while performing Tawaf under normal circumstances. Their study implemented SFM, modified to simulate group dynamics, by integrating the flocking technique into the SFM. Flocking is a popular technique to simulate large groups of agents. Reynolds (1987), the proponent of this technique, was inspired by the behaviour seen in flock of birds and schools of fish. He introduced an approach of simulating groups behaviours based on the interaction between agents following simple rules, called 'BOIDS'. In the Tawaf simulation, this integrated model was used to simulate group behaviours while in the circular motion. Several behaviours were observed through the simulation. For example, the group members maintained their position to be as close as possible to each other. In addition, if one of the group members was left slightly behind, the whole group would reduce its speed

accordingly, and the separated pilgrim increase his/her speed to catch up with the group. This study is useful to understand pilgrims' behaviours in a crowd in both normal and emergency situations and to aid Hajj authorities to plan for optimal crowd flow and prevent crowd incidents. However, the applicability of this model to large scale crowd is yet to be determined, as the number of the simulated agents was only 500.

Mahmood et al. (2017) proposed an ABM crowd simulation and analysis framework. They developed the model in a software platform called “Anylogic” and integrated it with external modules for optimisation and analysis of the crowd simulation results. Anylogic crowd simulation model provides both user-friendly integrated environment and an efficient simulation engine. These tools allow modellers to quickly create and simulate dense crowds. The main features of the proposed framework were: the ability to model a large crowd in a spatial environment at real-scale (e.g. stadium, malls, large mosques and spatial networks); simulating movement of high density crowds and their complex behaviours such as emergency evacuation using different experimental settings; and detailed assessment of crowd management and control strategies to evaluate evacuation plans.

This framework was used to evaluate three emergency evacuation strategies during Hajj: Random Crowd Evacuation (the crowd selects its exit randomly); Shortest Regional Distance (the crowd select the nearest gate by using the shortest path for evacuation); Genetic Algorithm (the crowd select the best evacuation solution that will minimise the total evacuation time for the whole crowd).

Using the proposed model for simulating crowd evacuation from the Grand Mosque led to the following results were obtained from 10 runs/strategy (Table 2-3).

Table 2-3: Anylogic results. Source: Mahmood et al. (2017)

Simulation factors	All three evacuation strategies
Population	10,000 agents
Evacuation time	1.3 minute
Average speed of the crowd	Min = 1.0 m/s; Max = 2.0 m/s Most likely = 1.4 m/s

2.7.3.2. Simulating Crowd at Aljamarat Bridge (Stoning the Devil Ritual)

Based on a video analysis of unique recordings of the human stampede of 2006, Helbing et al. (2007) presented explanations for the causes of the tragical incident, as well as solutions for improving the crowd management. According to their analysis, two sudden transitions led to “stop-and-go” flows at the entrance of the old Aljamarat Bridge and then “turbulent flows” and pressures occurred when the crowd density reached 9 pilgrims/m². The resulting stampede led for the loss of 346 lives and many injured pilgrims. Helbing et al. (2007) recommended several improvements:

- Increasing the stoning capacity and the crowd capacity at different levels of the bridge, by extending the three pillars using elliptical shape, as previously suggested by Dr Keith Still;
- Preventing crowd accumulation in the plaza around the Aljamarat Bridge and further designing a new plaza that allows the General Security to easily balance the pilgrims flows between the ground floor and the Northern and Southern ramps of the first floor; this would preclude overcrowding and breakdown of pilgrim flows;
- Replacing the two-way pilgrim flows on the streets and on the bridge by a one-way traffic, to avoid obstructions and counter-flows;
- Using a systematic scheduling system to homogeneously distribute pilgrims at the bridge;
- Providing an automated counting system of pilgrims and constant monitoring using the CCTV cameras.

Some of these recommendations were later appreciated to have had a key role in improving the organisation of the ritual after 2006: e.g., the separation of the flow’s directions and the reservation of space for emergency operations at Aljamarat Bridge (Al-Kodmany 2013).

Al-Kodmany (2013) used both Myriad 2 and Legion crowd models to test the new design of the Aljamarat Bridge. Legion is an ABM platform, focusing on modelling and simulating crowd behaviour, and ingress (entrance) and egress (exits) scenarios. In simulating evacuation scenarios, three situations were presented: choosing a random exit, choosing the nearest exit and all agents choosing the same exit. Agents can make movement decisions based on their current situations and constraints. A similar ABM platform, Myriad 2, was

used for multiple purposes and at various scales. Its uniqueness relies on the integration of three different analytic techniques: network analysis; spatial analysis; and agent-based analysis. For instance, Myriad 2 can model a transport network for a large scale crowds, then simulate the crowd movements and behaviours within a complex environment, such as a railway station, and then experiments with many types of crowd reactions. The uniqueness of this model is in the integration of: *Network analysis* (to simulate crowd movements in large complex spaces); *Spatial analysis* model (analyse the utilised spaces in complex environments); and *Agent analysis* (for modelling systems with complex behaviours and experimenting with many types of options of crowd reactions).

Al-Kodmany (2013) applied specific parameters in the Myriad 2 simulations, such as entrance and exit width, building crowds around the pillars and crowd flows at the bridge. On the other hand, Legion was used to test the safety impacts. Results of combining Legion and Myriad 2 for Aljamarat Bridge indicated that the new bridge design, the capacity and the elliptical shapes of the new pillars would improve pilgrims' safety at the bridge. As an extension, Dridi (2014) joined Simulex with Myriad 2 to measure queue progression when approaching Aljamarat Bridge. Simulex is a micro simulation model for emergency egress combined with Myriad 2 to extract the information on pilgrim's crowd density, speed and arrival time at the bridge (AlGadhi & Still 2003). A Legion model was developed to improve the conceptual design of the Jamarat Bridge (Dridi 2014). Data on Aljamarat bridge capacity, viewing range of the three Jamarat pillars, in-flux and out-flux of the crowd, speed and resting times, ingress (entrance) capacity and increase in the exit capacity were used for validation. Moreover, the approved design of the new Jamarat Bridge, with five levels was further tested in other simulation models (Illyas 2013).

Illyas (2013) applied NetLogo, a widely known platform for ABM, to simulate activities at the Aljamarat Bridge. This platform allows users, both beginners and experienced, to design, programme, test and analyse scenarios, and develop a scientific understanding (Railsback et al. 2017). NetLogo is popular due to its professional design and packages, good visualization, comprehensive documentation, and high-level programming language with many built-in commands and data types specialised for ABMs. Furthermore, it has an integrated graphical user interface for performing simulation experiments (Kornhauser et al. 2009). For Aljamarat simulation, this model presented two types of agents: aggressive agents, who walk faster and move

directly towards the Jamarat pillars without considering other pilgrims; and considerate agents, who walk slower and avoid crowds when moving towards the Jamarat. The simulation results match the real capacity of bridge (125,000 pilgrims per hour per level), and the rate of pilgrim flow on the bridge of 35 pilgrims/sec. A number of parameters were defined for this model. For example, the time required to perform this ritual, the stone throwing and the viewing range of the three Jamarat pillars. In addition, the analysis of pilgrims queuing and standing beside the Jamarat pillars was conducted for different shapes (circle and elliptical shapes). However, this study has not included many behaviours exhibited while performing the Rami Jamarat ritual. These might include congestion effects (e.g., stampede), emotion or anxiety that may lead to irrational behaviours, or avoiding collisions and physical interaction. Nevertheless, this study could improve managing crowds at Aljamarat Bridge by examining each Jamarat level divided into zones, to identify the crowded areas at each level. This will help Hajj authorities to identify critical crowded zones on all Aljamarat Bridge levels, and to distribute pilgrims to other less crowded levels before any harm could happen.

Fayoumi et al. (2011) used STEPS, a crowd management microsimulation tool, to simulate pilgrim dynamics under normal and in emergency situations. The model was used to optimize crowd movement and assist in emergency egress management. In addition, their system was used to predict individuals' movements in 3D- space. The authors ran four crowd simulation scenarios (models) A, B, C and D to improve the performance of pilgrim stoning processes in Hajj. Another main simulation result of this study was that the number of pilgrims performing Rami ritual can be increased by 25% by increasing the Jamarat basin by 20%. The results of this study could be used to develop the simulation of pilgrims on the Jamarat Bridge, expanding the architectural design of the Bridge and Jamarat pillars and assessing whether these expansions would affect the crowd management positively or negatively.

Klüpfel (2007) used a dynamic crowd model called PedGo, to simulate evacuation scenarios of large crowds of pilgrims (reaching 100,000 pilgrims at Aljamarat Bridge). This simulation showed how crowds separate during the process of evacuation, using the eight exits displayed in Figure 2-4.

Al-Kodmany (2013) highlighted that PedGo can run in real time. The outputs of this model include visual analysis, evacuation time, density plots and walking time. PedGo was used to test scenarios of crowd

evacuation from Aljamarat Bridge. It simulated 100,000 pilgrims being evacuated from the bridge to the exits after 10 minutes of the emergency. Al-Kodmany (2013) mentioned that Klüpfel (2007) focused on the “potential” aspect of this simulation, as he assumed the pedestrians have a common sense of the task and all of them are aware of all the nearest exits from their locations and taking the shortest path. This study could also be used to simulate huge numbers of pilgrims in other places, such as Al-Masjid Al-Haram.

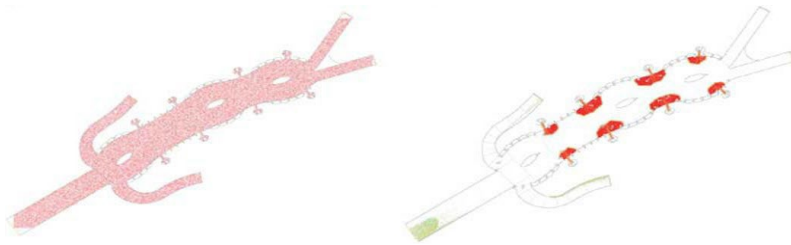

Figure 2-4: Simulating 100,000 agents to evacuate from Aljamarat Bridge. Sources: Klüpfel (2007)

PedGo is a crowd simulation model developed by Meyer-König and Klüpfel (Sarmady et al. 2007) to simulate emergency evacuation of larger crowds. It was an outcome of a research project called BYPASS (Al-Kodmany2013). PedGo can use different properties for the simulated pedestrians (e.g., maximum speed, patience, dawdle and sway) applying the normal probability distribution. In addition, as PedGo is a Cellular Automata (CA) model, it simulates the microscopic level of local movements of the pedestrians. Moreover, PedGo was applied to simulate emergency evacuation from crowded places (e.g. the egress from a sports stadium) (Klüpfel & Meyer-König 2005). In their review, Kuligowski et al. (2005) compared PedGo model with other crowd models. They mentioned that the purpose of the model is to model and simulate crowd movement, and the evacuation of pedestrians from crowded places, such as buildings, ships, and other kinds of public transportation. PedGo uses as a network structure that divides the geometry of its floor plan into 0.4 x 0.4 m grid cells and represents the space that is filled up by a person. In PedGo model, a set of rules is applied to all pedestrians regarding their movement in the model. However, PedGo is claimed to be a multi-Agent model, but the description of the model does not correspond with the definition of autonomous agents (Kukla 2007) and the agents do not communicate with each other. This model is a stochastic model, which

means that the behaviour of the modelled agent is determined by a parameterised probability distribution; each cell has a rule and transition occurs (e.g., if the next cell is empty, the agent can move into it) (Kukla 2007). PedGo is a microscopic CA model (Kukla 2007).

In conclusion, most of the simulation studies on Hajj have adopted and implemented ABM, CA and SFM, when modelling the Tawaf and Aljamarat rituals. ABM allows for heterogeneous agents to interact using simple rules and examining the emerging behaviour, while CA models can simplify crowd movements and representation, by using direct mapping of agent behaviours and cell update rules. However, CA (cells) do not present realistic behaviours and individual features. SFM provide continuous position representation of agents and use crowd movement foundation representing crowds as one homogeneous group (Sun 2013). These models can simulate normal crowd behaviours and evacuation situations, and some of them can simulate both conditions. Crowd modelling and simulation play a significant role in the development of new crowd management practices at mass gathering events.

2.8. Discussion

This chapter presented a survey of crowd and pedestrian models used to test and examine crowd behaviours and movements for Hajj events. Previous studies on modelling and simulating pilgrims in Haram Mosque and Aljamarat Bridge have provided many insights on how to improve crowd management and have highlighted the limitations of both modelling and practices. Many studies used ABM and focused on studying pilgrims' behaviours at these sites, how pilgrims interact with each other (collision avoidance) and with the surroundings of these sites. Other studies used CA to model each individual movement while performing Tawaf and Sayee at Haram, and how pilgrims progress and choose empty spaces in their movement. Finally, other studies used SFM to analyse pilgrim flows, while they perform Tawaf ritual around the Ka'bah. Very few scholars (e.g., Sarmady et al. 2008) applied a combination of microscopic and macroscopic models, to study both pilgrim interactions with each other and their movements as a crowd at Tawaf ritual. Most of these Hajj studies focused on using types of Microscopic models (ABM, CA and SFM), which indicates that each pilgrim's behaviour and action can eventually affect the crowd movement at Haram and Aljamarat Bridge. Table 2-4 identifies the main gaps from the literature review:

- All studies used micro models, except Sarmady et al. (2008) used a combination of micro and macro;
- All studies only covered a simulation of two holy sites, presenting a fragmented view of the Hajj event;
- Most maximum number of agents simulated did not exceed 25,000, which is a small number compared to the real number of pilgrims at Hajj events.

Table 2-4: Analysis of previous studies

Authors	Study Description	Model Type	Advantages/Benefits	Crowd Management Strategies	Gap
Al-Kodmany (2013)	Myriad 2 specifically developed by Professor Still for this purpose. The software provided detailed information on Aljamarat Bridge, such as arrival capacity, throwing area, space (as crowd density was four pilgrims/m ²) passing areas and egress capacity.	ABM	Detailed information about individuals Natural matching between agents and individuals	Provided assistance for the Hajj authorities for the development of pilgrims queuing and entering the Aljamarat Bridge.	These techniques could be used to improve Hajj crowd management and architectural designs at other Hajj places (e.g. Al-Masjid Al-Haram).
Dridi (2014)	Applies the crowd simulation model PedFlow ; verification and validation with video recordings of Hajj event 2009. Comparisons between PedFlow and Simulex/Myriad simulation models results.	ABM	Pedflow is more sophisticated in predicting the density of crowd and its dynamics. It can produce realistic crowd motion with agent moving at different speeds and under different situations while using collisions avoidance actions.		Using this simulator with updated data from crowds of pilgrims performing Tawaf and Sayee rituals. Using this simulator for other Hajj crowd places (e.g. Aljamarat Bridge, Arafat and Muzdalifah).
Fayoumi et al. (2011)	STEPS , a microsimulation tool, was used for simulating pilgrim dynamics under normal and emergency situations. This tool was additionally used to predict individuals' movements in 3D space.	CA	Detailed information about individuals' actions and behaviours. Natural matching between agents and individuals		This technique could be used to study the relationships between expanding other Hajj places and the crowd behaviours, movements and flows.
Illyas (2013)	NetLogo ABM model used for the ritual of 'stoning the devil' at the Aljamarat Bridge. Used to simulate the effect of different parameters of pilgrim movements, such as space between pilgrims and Jamarat pillars, hitting range, etc.	ABM	Able to simulate two types of individual behaviours. Able to simulate different shapes of Aljamarat pillars.	Analysing pilgrims queuing while standing beside the three Aljamarat pillars for the throwing ritual.	This model could simulate agents at other places, such as Tawaf area.
Khan and McLeod (2012)	Investigated the effect of Al-Masjid Al-Haram courtyard layout, pilgrim crowd properties and crowd management on crowd safety a spread of diseases via ABM.	ABM	Provides guidance on crowd management for Tawaf area.	Provided main guidelines for Tawaf crowd management (42 crowd simulation scenarios).	The crowd management results could be applied on other Hajj ritual sites.
Kim et al. (2015)	Method to model complex physical interaction between agents by using an interactive velocity-based multi-agent FSM framework. 35,000 agents were simulated in dense scenarios (8 agents/m ²), while interacting with other agents and with obstacles.	ABM	Combining velocity-based and collection avoidance algorithms with physical forces to model interactions between agents and obstacles in the simulated environment. It allows agents to anticipate and avoid collisions during local navigations (walking in the environment).	-----	Improving modelling by simulating pilgrim behaviour (e.g. interacting with other agents, with the environments' obstacles and avoiding collisions).
					Cont. next page

Authors	Study Description	Model Type	Advantages/Benefits	Crowd Management Strategies	Gap
Klűpfel (2007)	PedGo applied to simulate evacuation scenarios of large crowds (100,000 pilgrims at Aljamarat Bridge). This simulation showed how crowds were separated in the evacuation process.	CA/multi-agent	Natural matching between agents and individuals.	Analysing emergency situation (evacuation) of more than 100,000 pilgrims on Aljamarat Bridge.	This tool could be used to simulate evacuation scenarios at other Hajj places.
Mahmood et al. (2017)	Integrating Anylogic model with external modules for optimization and analysis of the crowd simulation, to evaluate crowd evacuation strategies.	ABM	Model large crowds in a spatial environment at real-scale, simulation emergency evacuation under different experimental settings. Complex behaviour, such as emergency evacuation, using different experimental settings. Detailed assessment of crowd management and control strategies.	This framework can be implemented for public safety and security management during events and other supporting decisions.	The study did not present any crowd management strategies in normal situations. The number of the simulated agents is small compared to the real number of pilgrims located inside and outside the Grand Mosque at Hajj peak time.
Mulyana and Gunawan, (2010)	Simulated pilgrims performing Tawaf as "intelligent" agents. Simulation matched the practical performance of real pilgrims during Tawaf and Sayee rituals.	ABM	The simulation could be used for training purposes before travelling to Al-Masjid Al-Haram (Kurdi et al., 2015).	Used as a pilgrims training tool for performing Hajj rituals.	Increasing the number of informed agents, to match the real number of pilgrims, could be tested. Using simulation not only for training, but also for improving Hajj crowd management.
Nasir and Sunar (2016)	SFM and flocking techniques applied for simulation of group behaviour in a crowd in normal situation while performing the Tawaf ritual	SFM	Present several behaviours that were observed from the simulation of Tawaf.	This model helps to understand pilgrim behaviour in a crowd and assists Hajj authorities to plan for optimal crowd flows and prevent incidents.	Simulate group behaviours under emergency situations such as evacuation. Increase the number of agents to the real number of pilgrims at Hajj. The flocking technique could be used for validating simulating ABM simulation of individual behaviour in a group.
Sarmady et al. (2008)	Combined macroscopic model for crowd movements and CA, for collision avoidance and use of shorter paths during Tawaf rituals. The integrated system was capable of simulating up to 23,000 agents in real time.	Hybrid model (Macro + CA)	The ability to simulate a large number of crowds on a single computer [51]	-----	Focus additionally on simulating crowd behaviours while performing Tawaf ritual (e.g. interacting with other agents, with obstacles and avoiding collisions).
Siddiqui and Gwynne (2012)	Used EXODUS model for simulating pilgrims performing the Sayee ritual at the Grand Mosque (Almasjid Alharam).	CA	This model was used to understand the importance of individual behaviour when simulating large crowds of pilgrims (15,000 agents).	Provided prior planning for emergency situations for Hajj events.	This tool could be used to simulate evacuation scenarios at other Hajj places (e.g. Al-Masjid Al-Haram).
Zainuddin et al. (2009)	Simulated the circumambulation of Ka'ba using SimWalk. This study suggested various mitigation measures to ease the pilgrims' flows in the Tawaf area. The results of this study showed that building the spiral path is an effective solution in ensuring a smooth flow in Tawaf area.	SFM	The ability to design and analyse crowd flows using SFM (Kurdi et al., 2015)	Proposed to design new exits for pilgrims after completing their Tawaf rituals (e.g., building an underground tunnel or overhead bridge to exit from the Grand Mosque without interfering with the arriving pilgrims).	Increase the number of simulated pilgrims to be matched with the real number of pilgrims.

2.9. Conclusion

Mass gathering (MG) events pose significant planning and management challenges. As a case study, Hajj is an MG event which attracts millions of pilgrims to perform rituals at four holy sites. This chapter reviewed the latest crowd modelling and simulation studies, and the most important models and software packages used for the Hajj in both normal and emergency situations. Hajj is relevant as an MG event primarily because of its scale and one that faces major problems, such as overcrowding, congestion, people getting lost, stampedes, injuries and deaths. Therefore, Hajj authorities are interested in using models and latest technologies for planning the events and for managing pilgrims at the holy sites. Crowding problems can be studied prior to the events using simulation models. This chapter identified three main groups of modelling techniques — agent-based modelling, cellular automata and social force — each with specific benefits and limitations. The chapter critically assessed these models, identifying potential applications to other rituals or locations and directions for new research, which can assist the planning and operation of MG event, irrespective of their nature.

Acknowledgement

The main author of this study is funded and sponsored by the Saudi Arabian Cultural Mission in Australia, the representative of the Royal Embassy of the Kingdom of Saudi Arabia. The authors thank the reviewers and editors for their valuable comments which helped in improving the manuscript.

References

1. Alaska, Y. A., Aldawas, A. D., Algerian, N. A., Memish, Z. A. & Suner, S. (2016), The impact of crowd control measures on the occurrence of stampedes during mass gatherings: The Hajj experience, *Travel Medicine and Infectious Disease*, 15, 67-70.
2. Abdelghany, A., Abdelghany, K., & Mahmassani, H. (2016), A hybrid simulation-assignment modelling framework for crowd dynamics in large-scale pedestrian facilities, *Transportation Research Part A: Policy and Practice*, 86, 159-176.
3. Abdelghany, A., Abdelghany, K., Mahmassani, H., & Al-Zahrani, A. (2012). Dynamic simulation assignment model for pedestrian movements in crowded networks, *Transportation Research Record*, (2316), 95-105.
4. AlGadhi, S. A. & Still, K. G. (2003), Jamarat bridge mathematical models, computer simulation and Hajjis safety analysis, *Ministry of Hajj, Jeddah, Saudi Arabia*.
5. Aljohani, A. (2015), Pilgrim crowd dynamics, PhD thesis, University of Birmingham.
6. Al-Kodmany, K. (2013). Crowd management and urban design: New scientific approaches, *Urban Design International*, 18(4), 282-295.

7. Al-Kodmany, K. (2011). Planning for safety: the case of the symbolic stoning of the devil in Hajj, *Journal of Architectural and Planning Research*, 28-43.
8. Al-Nabulsi, H. H. (2015). The crowd psychology of the Hajj, PhD Thesis, University of Sussex, UK.
9. Al-Nabulsi, H. H. (2009). How can vulnerability and risk be reduced in large-scale gatherings? An assessment of vulnerability and risk in mass gatherings, Master thesis, School of Built Environment, Oxford Brookes University, Oxford, UK.
10. Alqahtani, S., Kaoruko, Y., Al Qahtani, W., Tahani, M., Heywood, A., Booy, R., Wiley, K. & Rashid, H. (2017), Australian Hajj pilgrims' perception about mass casualty incidents versus emerging infections at Hajj, *Travel Medicine and Infectious Disease*, 15, 81-83.
11. Alshammari, S. M. and Mikler, A. R. (2015), Modelling disease spread at global mass gatherings: Hajj as a case study, In *2015 International Conference on Healthcare Informatics (ICHI)*, (pp. 574-577). IEEE.
12. Amro, A. & Nijem, Q. (2012), Pilgrims Hajj tracking system (e-Mutawwif), *Contemporary Engineering Sciences*, 5(9), 437-446.
13. Bakar, N. A. A., Majid, M. A. and Ismail, K. A. (2017), An overview of crowd evacuation simulation, *Advanced Science Letters*, 23(11), 11428-11431.
14. Bonabeau, E. (2002), Agent-based modelling: Methods and techniques for simulating human systems, *Proceedings of the National Academy of Sciences*, 99(3), 7280-7287.
15. Čablová, L., Pates, R., Miovský, M and Noel, J. (2017), How to Write a Systematic Review Article and Meta-Analysis. In: Babor, T F, Stenius, K, Pates, R, Miovský, M, O'Reilly, J and Candon, P. (eds.) *Publishing Addiction Science: A Guide for the Perplexed*, pp. 173–189. London: Ubiquity Press. DOI: <https://doi.org/10.5334/bbd.i>. License: CC-BY 4.0.
16. Che, X., Niu, Y., Shui, B., Fu, J., Fei, G., Goswami, P. and Zhang, Y. (2015), A novel simulation framework based on information asymmetry to evaluate evacuation plan. *The Visual Computer*, 31(6-8), 853-861.
17. Curtis, S., Guy, S. J., Zafar, B. and Manocha, D. (2011), Virtual tawaf: A case study in simulating the behaviour of dense, heterogeneous crowds, In *2011 IEEE International Conference on Computer Vision Workshops (ICCV Workshops)*, (pp. 128-135). IEEE.
18. Dridi, M. H. (2014), Pedestrian flow simulation validation and verification techniques, *arXiv preprint arXiv:1410.0603*.
19. Drury, J., Novelli, D., & Stott, C. (2013). Representing crowd behaviour in emergency planning guidance: 'Mass panic' or collective resilience?. *Resilience*, 1(1), 18-37.
20. Edrees, M. (2016), The role of urban design in crowd control case study Jamarat area, available at <https://www.researchgate.net/publication/310346287> The Role of Urban Design in Crowd Control Case Study Jamarat Area
21. Edrees, M. (2012), An urban study for crowded sites in Arafat area, available at <https://www.researchgate.net/publication/309741711> An Urban Study for Crowded Sites in Arafat Area
22. Edrees, M., (2005), Developing methods to control pilgrims' density and movement in Jamarat area, available at <https://www.researchgate.net/publication/310605027> Developing Methods to Control Pilgrims Density and Movement in Jamarat Area
23. Fayoumi, A., Al-Ghoraibi, S., Fadel, A., Al-Aswadi, F., Mujallid, F. and Wazzan, M. (2011), A simulator to improve the pilgrims' performance in stoning ritual in Hajj, *International Journal of Computer Science and Network Security*, 11(5), 141-144.
24. Felemban, E. and Basalamah, S. (2011), User requirements for localization and positioning during Hajj, In *2011 International Conference on Indoor Positioning and Indoor Navigation (IPIN, 21-23 September 2011)*, Guimarães, Portugal, 21-23.
25. Friberg, M. and Hjelm, M. (2015), Mass evacuation-human behaviour and crowd dynamics-What do we know?, *LUTVDG/TVB*, 1-61.
26. Hajj Centre of Research Excellence (CORE) (2010), Background material toolkit. Umm Al Qura University, available at http://wwwusers.cs.umn.edu/~shekhar/talk/2013/Hajj%20CORE%20TOOLKIT_09042010.pdf
27. Halabi, W. S. (2006). Overcrowding and the Holy Mosque, Doctoral dissertation, *University of Newcastle Upon Tyne*. The UK.
28. Helbing, D & Johansson, A. (2011). Pedestrian, crowd and evacuation dynamics. *Extreme Environmental Events*, pp. 697-716.
29. Helbing, D., Johansson, A., and Al-Abideen, H. Z. (2007). Dynamics of crowd disasters: An empirical study. *Physical Review E*, 75(4), 046109.
30. Illyas, Q. (2013), NetLogo Model for Ramy Al-Jamarat in Hajj, *Journal of Basic and Applied Scientific Research*, 3(12), 199-209.

31. Imam, A. and Alamoudi, M. (2014), Mina: the city of tents origination and development, In *9° Congresso Città e Territorio Virtuale, Roma*, 2, 3 e 4 ottobre 2013 (pp. 1351-1365). Università degli Studi Roma Tre.
32. Jbira, M. K. and Lakhoua, M. N. (2012), Functional analysis of congestion state caused by pilgrims' crowd using SADT aiding on the design of a new supervisory system, *Journal of Electrical and Electronics Engineering*, 5(1), 105-110.
33. Johansson, A., Batty, M., Hayashi, K., Al Bar, O., Marcozzi, D. and Memish, Z. (2012), Crowd and environmental management during mass gatherings, *The Lancet Infectious Diseases*, 12(2), 150-156.
34. Kaban, B. (2016), Crowd dynamics: Modelling pedestrian movement and associated generated forces, PhD Thesis, Université Paris-Est.
35. Khan, A. A. and Noji, E. K. (2016), Hajj stampede disaster, 2015: Reflections from the frontlines, *American Journal of Disaster Medicine*, 11(1), 59-68.
36. Khan, I. (2012), Hajj crowd management: Discovering superior performance with agent-based modelling and queueing theory, PhD Thesis, University of Manitoba.
37. Khan, I. and McLeod, R. (2012), Managing Hajj crowd complexity: Superior throughput, satisfaction, health, & safety, *Kuwait Chapter of Arabian Journal of Business and Management Review*, 2(4), 45-59.
38. Khozium, M., Abuarafah, A. and AbdRabou, E. (2012), A proposed computer-based system architecture for crowd management of pilgrims using thermography, *Life Science Journal*, 9(2), 377-383.
39. Kim, S., Guy, J., Hillesland, K., Zafar, B., Gutub, A. and Manocha, D. (2015), Velocity-based modelling of physical interactions in dense crowds, *The Visual Computer*, 31(5), 541-555.
40. Klüpfel, H. (2007), The simulation of crowd dynamics at very large events Calibration, empirical data, and validation, In *Pedestrian and Evacuation Dynamics 2005*, Springer Berlin Heidelberg, pp. 285-296.
41. Klüpfel, H., & Meyer-König, T. (2005). Simulation of the Evacuation of a football stadium using the CA Model PedGo. In *Traffic and Granular Flow'03* (pp. 423-428). Springer, Berlin, Heidelberg.
42. Kornhauser, D., Wilensky, U. and Rand, W. (2009), Design guidelines for agent based model visualization, *Journal of Artificial Societies and Social Simulation*, 12(2).
43. Krausz, B., & Bauckhage, C. (2011, August). Automatic detection of dangerous motion behavior in human crowds. In *2011 8th IEEE International Conference on Advanced Video and Signal Based Surveillance (AVSS)* (pp. 224-229). IEEE.
44. Kukla, R. (2007). A software framework for the microscopic modelling of pedestrian movement (Doctoral dissertation, *Edinburgh Napier University*).
45. Kuligowski, E. D., Peacock, R. D., & Hoskins, B. L. (2005). A review of building evacuation models. Gaithersburg, MD: US Department of Commerce, National Institute of Standards and Technology.
46. Kurdi, O. (2017), Crowd modelling and simulation, PhD thesis, University of Sheffield.
47. Kurdi, O., Stannett, M. and Romano, D. (2015), Modelling and simulation of Tawaf and Sa'yee: A survey of recent work in the field, In *29th The European Simulation and Modelling Conference 2015, 26 - 28 Oct 2015*, Leicester, UK.
48. Mahmood, I., Haris, M. and Sarjoughian, H. (2017), Analysing emergency evacuation strategies for mass gatherings using crowd simulation and analysis framework: Hajj scenario, In *Proceedings of the 2017 ACM SIGSIM Conference on Principles of Advanced Discrete Simulation* (pp. 231-240). ACM.
49. Memish, Z. A., Stephens, G. M., Steffen, R. and Ahmed, Q. A. (2012), Emergence of medicine for mass gatherings: lessons from the Hajj, *The Lancet Infectious Diseases*, 12(1), 56-65.
50. Memish, Z., Zumla, A., Alhakeem, R., Assiri, A., Turkestani, A., Al Harby, K., Alyemni, M. (2014), Hajj: infectious disease surveillance and control. *The Lancet*, 383(9934), 2073-2082. doi:10.1016/S0140-6736(14)60381-0.
51. Mohamad, S., Sunar, M.S. & Hanifa, R. (2014), "A review on Tawaf crowd simulation: State-of-the-art, *International Journal of Interactive Digital Media*, 2(11), 119-123.
52. Mulyana, W. and Gunawan, T. (2010), Hajj crowd simulation based on intelligent agent. In *2010 International Conference on Computer and Communication Engineering (ICCCCE)*, (pp. 1-4), IEEE.
53. Nasir, F. M. and Sunar, M. S. (2016), Simulating large group behaviour in tawaf crowd, In *2016 Asia Pacific Conference Multimedia and Broadcasting (APMediaCast)*, on (pp. 42-46). IEEE.
54. Osman, M. and Shaout, A. (2014), Hajj Guide Systems-Past, Present and Future, *International Journal of Emerging Technology and Advanced Engineering*, 4(8), 25-31.
55. Owaidah, A. (2015), Hajj crowd management via a mobile augmented reality application: a case of The Hajj event, Saudi Arabia, Masters' Dissertation, University of Glasgow.
56. Paeveen, Z. and Aldhlan, K. (2016), Missing pilgrims tracking system using GPS, GSM and Arduino Microcontroller, In *International Conference on Recent Advances in Computer Systems (RACS 2015)*, 30 November - 1 December 2015, Hail, Saudi Arabia, 23-27.

57. Rahman, J., Thu, M., Arshad, N. and Van der Putten, M. (2017), Mass gatherings and public health: Case studies from the Hajj to Mecca, *Annals of Global Health*, 83(2), 386-393.
58. Railsback, S., Ayllón, D., Berger, U., Grimm, V., Lytinen, S., Sheppard, C. and Thiele, J. (2017), Improving execution speed of models implemented in NetLogo. *Journal of Artificial Societies and Social Simulation*, 20(1).
59. Reda, O. M. (2016), Mobile ad hoc networks group mobility models of Hajj crowd dynamics, *International Journal of Applied Engineering Research*, 11(22), 10772-10778.
60. Sarmady, S., Haron, F. and Talib, A. (2010), Simulating crowd movements using fine grid cellular automata”, In *2010 12th International Conference on Computer Modelling and Simulation (UKSim)*, (pp. 428-433). IEEE.
61. Sarmady, S., Haron, F. and Talib, A. (2008), Multi-agent simulation of circular pedestrian movements using cellular automata, In *Modelling & Simulation, 2008. AICMS 08. Second Asia International Conference on.* (pp. 654-659), IEEE.
62. Sarmady, S., Haron, F., & Talib, A. Z. (2007). Evaluation of existing software for simulating of crowd at Masjid Al-Haram. *Journal Pengurusan Jabatan Wakaf Zakat & Haji*, 1(1), 83-95.
63. Saudi Civil Defence 2017, accessed 25/04/2017, <http://www.998.gov.sa/AR/Pages/hajj.aspx>
64. Seliaman, M. E., Duffuaa, S. and Andijani, A. (2013), A Stochastic Simulation Model for the Design of a Shuttle Bus System to Transport Pilgrims in Hajj, *ResearchGate*, Berlin
65. Sharma, D., Bhondekar, A., Shukla, A. and Ghanshyam, C. (2016), A review on technological advancements in crowd management, *Journal of Ambient Intelligence and Humanized Computing*, 1-11.
66. Shalaby, A., Isam, K., Al-Zahrani, A., Alshalalfah, B. and Sayegh, A. (2013), Towards a sustainable transportation system for the Holy City of Makkah: Coping with harsh topography, dense urban area and large-scale religious events, In: *17th International Road Federation (IRF) World Meeting and Exhibition 2013*, 1-15.
67. Shiwakoti, N., & Sarvi, M. (2013). Understanding pedestrian crowd panic: a review on model organisms approach. *Journal of transport geography*, 26, 12-17.
68. Shuaibu, A. N., Faye, I., Malik, A. and Simsim, M. (2015), Simulation of crowd movement in spiral pattern during Tawaf, in Makkah, Saudi Arabia, *Modern Applied Science*, 9(11), 192-202.
69. Siddiqui, A. A. and Gwynne, S. M. V. (2012), Employing pedestrian observations in engineering analysis, *Safety Science*, 50(3), 478-493.
70. Sowmya, M. and Kumar, B. (2014), Smart way of tracking and assistance of pilgrims using android, *International Journal of Engineering Trends and Technology (IJETT)*, 16(9), 410-413.
71. Sun, Q. (2013), A generic approach to modelling individual behaviours in crowd simulation, PhD Thesis, University of Salford, UK.
72. Taibah H, Arlikatti S. (2015), An Examination of Evolving Crowd Management Strategies at Pilgrimage Sites: A Case Study of 'Hajj' in Saudi Arabia. *International Journal of Mass Emergencies & Disasters [serial online]*. August 2015;33(2):188-212.
73. Tayan, O. (2010), A proposed model for optimizing the flow of pilgrims between Holy sites during Hajj using traffic congestion control, In *Proceedings of the International Journal of Engineering and Technology*, 10(2), pp.55-59.
74. Tunasar, C. (2013), Analytics driven master planning for Mecca: Increasing the capacity while maintaining the spiritual context of HAJJ pilgrimage. In *Proceedings of the 2013 Winter Simulation Conference: Simulation: Making Decisions in a Complex World* (pp. 241-251), IEEE.
75. Turris, S. A., Lund, A., Hutton, A., Bowles, R., Ellerson, E., Steenkamp, M., Ranse, J. & Arbon, P. (2014). Mass-gathering health research foundational theory: part 2-event modelling for mass gatherings. *Prehospital and Disaster Medicine*, 29(6), 655-663.
76. UK Cabinet Office (2009), Understanding crowd behaviours: Supporting Evidence, available at
77. https://www.gov.uk/government/uploads/system/uploads/attachment_data/file/192606/understanding_crowd_behaviour-supporting-evidence.pdf
78. Ulicny, B., & Thalmann, D. (2001). Crowd simulation for interactive virtual environments and VR training systems. In *Computer Animation and Simulation 2001* (pp. 163-170). Springer, Vienna.
79. Yamin, M. (2015), Secure and healthy Hajj management: A technological overview, *American Academic & Scholarly Research Journal*, 7(3), 195-202.
80. Yaseen, S., Al-Habaibeh, A., Su, D. and Otham, F. (2013), Real-time crowd density mapping using a novel sensory fusion model of infrared and visual systems, *Safety Science*, 57, 313-325.
81. Zainuddin, Z., Thinakaran, K. and Abu-Sulyman, I. M. (2009), Simulating the circumambulation of the Ka'aba using SimWalk, *European Journal of Scientific Research*, 38(3), 454-464.
82. Zawbaa, H. and Aly, S. A. (2012), Hajj and Umrah event recognition datasets, *arXiv preprint arXiv: 1205.2345*.

Appendix: PRISMA 2009 Flow Diagram

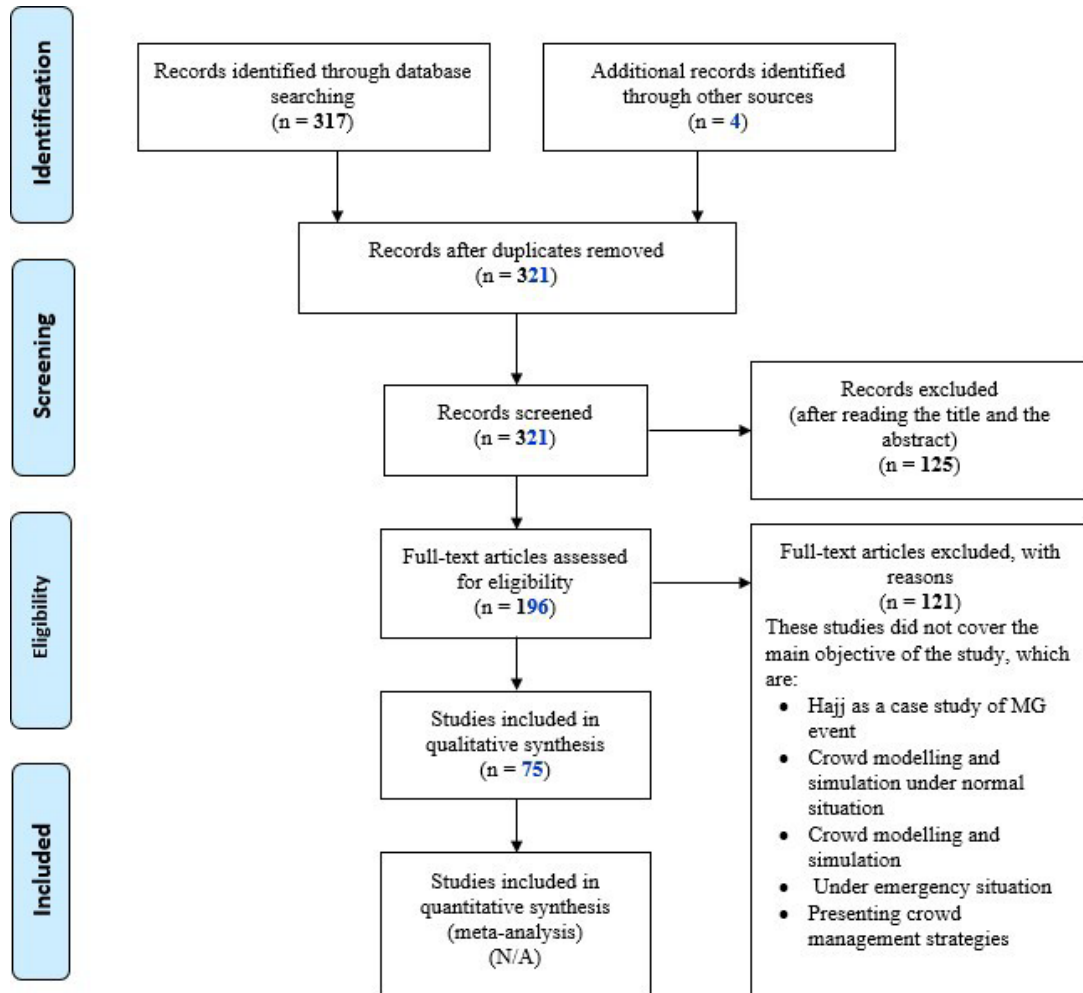

Figure 2-5: PRISMA flow diagram for the literature review.

Table 2-5: Selection criteria for the literature review

Study and year of publication	Publication Keywords	Selection Criteria				
		Using Hajj as a case study of MG event	Describing some detail information of Hajj event	Crowd modelling and simulation for normal situation	Crowd modelling and simulation under emergency situation	Presenting crowd management procedures and strategies
Alaska et al. (2016)	Mass gathering, Jamarat, Hajj.	✓	✓			
Abdelghany et al. (2016)	Hajj, crowd dynamics, pedestrian flow.	✓	✓			
Abdelghany et al. (2012)	Pedestrian movements, crowd management, Makkah.	✓	✓			
AlGadhi and Still (2003)	Hajj, Aljamarat Bridge, crowd modelling, crowd simulation.	✓	✓	✓		
Aljohani (2015)	Hajj, crowd dynamics, Holy Mosque, Holy sites.	✓	✓			
Al-Kodmany (2013)	Crowd management, software tools, design testing, operational plans and Hajj	✓	✓	✓	✓	✓
Al-Kodmany (2011)	Hajj, Aljamarat Bridge, stoning the devil, crowd safety.	✓	✓			
Al-Nabulsi (2015)	Hajj, crowd, psychology.	✓	✓			
Al-Nabulsi (2009)	Hajj, mass gatherings, risk assessment.	✓	✓			
Alqahtani et al. (2017)	Hajj, mass gathering, stampede, crowd disaster, crowd incidents, Hajj incidents	✓	✓			
Alshammari and Mikler (2015)	Mass gatherings, Hajj.	✓	✓			
Amro & Nijem (2012)	Hajj, pilgrims, tracking, lost.	✓	✓			
Bakar et al. (2017)	Crowd modelling, crowd simulation, crowd evacuation, modelling and simulation			✓	✓	
Bonabeau (2002)	Modelling, ABM.			✓		
Che et al. (2015)	Crowd modelling, crowd simulation.			✓		
Curtis et al. (2011)	Hajj, Tawaf, crowd modelling	✓	✓	✓		
Dridi (2014)	Pedestrian simulation, verification of simulation tools	✓	✓	✓		✓
Edrees (2016)	Hajj, urban design, crowd control, Aljamarat Bridge, open space.	✓	✓			
Edrees (2012)	Hajj, pilgrims, Arafat, crowded sites, urban, congested sites.	✓	✓			
Edrees (2005)	Hajj, control pilgrims, density, movement, Aljamarat Bridge.	✓	✓			
Fayoumi et al. (2011)	Crowd management simulation tools, stoning in Hajj and Aljamarat Bridge	✓	✓	✓	✓	
Felemban and Basalamah (2011)	Hajj, pilgrims, localization, city of Makkah.	✓	✓			
Friberg and Hjelm (2015)	Crowd behavior, human behavior, crowd dynamics, crowd incidents, Mina.	✓				
Hajj CORE (2010)	Hajj, Holy sites, Makkah.	✓	✓			
Helbing et al. (2007)	Hajj, Aljamarat Bridge, crowd management	✓	✓			✓

Study and year of publication	Publication Keywords	Selection Criteria				
		Using Hajj as a case study of MG event	Describing some detail information of Hajj event	Crowd modelling and simulation for normal situation	Crowd modelling and simulation under emergency situation	Presenting crowd management procedures and strategies
Ilyas (2013)	Crowd simulation, Hajj, Ramy, stoning the devil, Jamarat and NetLogo	✓	✓	✓	✓	✓
Imam and Alamoudi (2014)	Hajj sites, pilgrimage, Mina, tent city.	✓	✓			
Jbira and Lakhoua (2012)	Hajj, Mina, congestions.	✓	✓			
Johansson et al. (2012)	Hajj, mass gathering, crowd modeling, crowd simulation	✓	✓	✓		
Kabalan (2016)	Crowd modelling, crowd simulation, crowd dynamics.			✓		
Khan and Noji (2016)	Hajj, mass gathering, stampede, Mina, crowd management.	✓	✓			
Khan (2012)	Hajj, crowd management, crowd modelling, crowd simulation, ABM, Tawaf.	✓	✓	✓		
Khan and McLeod (2012)	Crowd simulation, agent-based modelling and simulation, mass gathering, Hajj, Tawaf, decision support systems, operations management	✓	✓	✓	✓	✓
Khoziun, et al. (2012)	Hajj, crowd management, crowd density, crowd monitoring, Nafrah.	✓	✓			
Kim et al. (2015)	Hajj, Tawaf simulation, Multi-agent simulation, Physical interactions	✓	✓	✓		✓
Klupfel (2007)	Hajj, Al-Jamaramt Bridge, crowd modelling, crowd simulation, pedestrian flow, route choice	✓	✓	✓	✓	✓
Klupfel and Meyer-Konig (2005)	Crowd modelling and simulation, PedGo				✓	
Kornhauser et al. (2009)	Modelling, NetLogo.			✓		
Krausz and Bauckhage (2011)	Mass Gathering events, crowd management					✓
Kukla (2007)	Crowd modelling and simulations			✓	✓	
Kuligowski et al. (2005)	Crowd modelling and simulation			✓	✓	
Kurdi (2017)	Crowd modelling, crowd simulation, crowd behaviors, Hajj, Sayee.	✓	✓	✓	✓	
Kurdi et al. (2015)	Hajj, modelling, simulation, ABM, crowd modelling, crowd simulation, Tawaf, Sayee.	✓	✓	✓	✓	
Mahmood et al. (2017)	Emergency evacuation strategies, agent-based crowd simulation, Hajj scenarios.	✓	✓	✓	✓	✓
Memish et al. (2012)	Mass gatherings, Hajj.	✓	✓			
Memish et al. (2014)	Hajj, religious festival, gathering	✓	✓			
Mohamad et al. (2014)	Hajj, crowd modelling, crowd simulation, Tawaf.	✓	✓	✓	✓	
Mulyana and Gunawan (2010)	crowd simulation, hajj, agent, behavior, pilgrim	✓	✓	✓		✓
Nasir and Sunar (2016)	Computer animation, modelling and simulation	✓	✓	✓	✓	✓

Study and year of publication	Publication Keywords	Selection Criteria				
		Using Hajj as a case study of MG event	Describing some detail information of Hajj event	Crowd modelling and simulation for normal situation	Crowd modelling and simulation under emergency situation	Presenting crowd management procedures and strategies
	techniques and crowd simulation					
Osman and Shaout (2014)	Hajj, crowd management, pilgrims.	✓	✓			
Owaidah (2015)	Hajj, crowd management, crowd incidents.	✓	✓			
Paeveen and Aldhlan (2016)	Hajj, missing pilgrims, pilgrims tracking, lost pilgrims.	✓	✓			
Rahman et al. (2017)	Mass gathering, Hajj.	✓	✓			
Railsback et al. (2017)	Modelling, NetLogo.			✓		
Reda (2016)	Hajj, Hajj management, pilgrims, crowd dynamics.	✓	✓			
Sarmady et al. (2010)	Crowd modelling, crowd simulation, crowd movement, CA models.			✓		
Sarmady et al. (2008)	Behavior modelling, crowd modelling, simulation, Cellular Automata, multi-agent and pedestrian	✓	✓	✓		✓
Sarmady et al. (2007)	Hajj, Tawaf ritual, crowd modelling and simulation	✓	✓	✓	✓	✓
Saudi Civil Defence (2017)	NA (website)	✓	✓			
Seliaman et al. (2013)	Hajj, Holy sites, Arafat, Muzdalifah.	✓	✓			
Sharma, et al. (2016)	Hajj, crowd management, crowd modelling, corwd simulation	✓	✓	✓		
Shalaby et al. (2013)	Holy city, Makkah, urban area, large-scale event, religious event.	✓	✓			
Shuaibu et al. (2015)	Hajj, Tawaf, crowd movement, pedestrian, congestion.	✓	✓			
Siddiqui and Gwynne (2012)	Pedestrian dynamics, simulation, analysis, crowd and Hajj	✓	✓	✓	✓	✓
Sowmya, and Kumar (2014)	Mass gathering, Hajj.	✓	✓			
Sun (2013)	Crowd modelling, crowd simulation, crowd behavior, individual behavior.			✓		
Taibah and Arlikatti (2015)	Crowd management, Hajj	✓	✓			
Tayan (2010)	Hajj, Holy sites.	✓	✓			
Tunasar (2013)	Hajj, pilgrims, Mecca.	✓	✓			
Turris et al. (2014)	Mass Gathering events	✓				
UK Cabinet Office (2009)	Crowd behavior, Hajj, crowd modelling, crowd simulation.	✓	✓	✓	✓	✓
Yamin (2015)	Hajj, crowd management, crowd, pilgrims.	✓	✓			
Yaseen et al. (2013)	Hajj, pilgrimage, Mecca, crowd safety.	✓	✓			
Zainuddin et al. (2009)	Hajj, crowd modelling, crowd simulation, Tawaf simulation, pedestrian flow, Ka'aba, SFM.	✓	✓	✓		✓
Zawbaa and Aly (2012)	Hajj, Umrah, Hajj rituals.	✓	✓			

Table 2-6: PRISMA Checklist

Section/topic	#	Checklist item	Reported on page #
TITLE			
Title	1	Identify the report as a systematic review, meta-analysis, or both.	Chapter 2: Review of Modelling and Simulating Crowds at Mass Gathering Events: Hajj as a Case Study
ABSTRACT			
Structured summary	2	Provide a structured summary including, as applicable: background; objectives; data sources; study eligibility criteria, participants, and interventions; study appraisal and synthesis methods; results; limitations; conclusions and implications of key findings; systematic review registration number.	Abstract
INTRODUCTION			
Rationale	3	Describe the rationale for the review in the context of what is already known.	2.2. Literature Search Framework
Objectives	4	Provide an explicit statement of questions being addressed with reference to participants, interventions, comparisons, outcomes, and study design (PICOS).	2.2. Literature Search Framework
METHODS			
Protocol and registration	5	Indicate if a review protocol exists, if and where it can be accessed (e.g., Web address), and, if available, provide registration information including registration number.	N/A
Eligibility criteria	6	Specify study characteristics (e.g., PICOS, length of follow-up) and report characteristics (e.g., years considered, language, publication status) used as criteria for eligibility, giving rationale.	Table 2-5: Selection criteria for the literature review
Information sources	7	Describe all information sources (e.g., databases with dates of coverage, contact with study authors to identify additional studies) in the search and date last searched.	2.2. Literature Search Framework
Search	8	Present full electronic search strategy for at least one database, including any limits used, such that it could be repeated.	2.2. Literature Search Framework
Study selection	9	State the process for selecting studies (i.e., screening, eligibility, included in systematic review, and, if applicable, included in the meta-analysis).	2.2. Literature Search Framework
Data collection process	10	Describe method of data extraction from reports (e.g., piloted forms, independently, in duplicate) and any processes for obtaining and confirming data from investigators.	N/A
Data items	11	List and define all variables for which data were sought (e.g., PICOS, funding sources) and any assumptions and simplifications made.	N/A
Risk of bias in individual studies	12	Describe methods used for assessing risk of bias of individual studies (including specification of whether this was done at the study or outcome level), and how this information is to be used in any data synthesis.	N/A
Summary measures	13	State the principal summary measures (e.g., risk ratio, difference in means).	N/A
Synthesis of results	14	Describe the methods of handling data and combining results of studies, if done, including measures of consistency (e.g., I^2) for each meta-analysis.	Table 2-5: Selection criteria for the literature review
Risk of bias across studies	15	Specify any assessment of risk of bias that may affect the cumulative evidence (e.g., publication bias, selective reporting within studies).	N/A
Additional analyses	16	Describe methods of additional analyses (e.g., sensitivity or subgroup analyses, meta-regression), if done, indicating which were pre-specified.	N/A
RESULTS			
Study selection	17	Give numbers of studies screened, assessed for eligibility, and included in the review, with reasons for exclusions at each stage, ideally with a flow diagram.	Table 2-5: Selection criteria for the literature review
Study characteristics	18	For each study, present characteristics for which data were extracted (e.g., study size, PICOS, follow-up period) and provide the citations.	2,3

Section/topic	#	Checklist item	Reported on page #
Risk of bias within studies	19	Present data on risk of bias of each study and, if available, any outcome level assessment (see item 12).	N/A
Results of individual studies	20	For all outcomes considered (benefits or harms), present, for each study: (a) simple summary data for each intervention group (b) effect estimates and confidence intervals, ideally with a forest plot.	N/A
Synthesis of results	21	Present results of each meta-analysis done, including confidence intervals and measures of consistency.	N/A
Risk of bias across studies	22	Present results of any assessment of risk of bias across studies (see Item 15).	N/A
Additional analysis	23	Give results of additional analyses, if done (e.g., sensitivity or subgroup analyses, meta-regression [see Item 16]).	N/A
Study characteristics	18	For each study, present characteristics for which data were extracted (e.g., study size, PICOS, follow-up period) and provide the citations.	3,4
DISCUSSION			
Summary of evidence	24	Summarize the main findings including the strength of evidence for each main outcome; consider their relevance to key groups (e.g., healthcare providers, users, and policy makers).	2.8. Discussion and 2.9. Conclusion
Limitations	25	Discuss limitations at study and outcome level (e.g., risk of bias), and at review-level (e.g., incomplete retrieval of identified research, reporting bias).	2.8. Discussion and 2.9. Conclusion
Conclusions	26	Provide a general interpretation of the results in the context of other evidence, and implications for future research.	2.9. Conclusion
FUNDING			
Funding	27	Describe sources of funding for the systematic review and other support (e.g., supply of data); role of funders for the systematic review.	2.9. Conclusion

Table 2-7: Classification of MG events

Event dimension	Category/Criterion	Examples
Demographics	Event Type	Races, sport events (e.g., cycling), religious pilgrimages, cultural events, and music festivals
	Geography	Environment bounded or unbounded, shifting or fixed footprint, site (and egress, multi or single venue)
	Temporality	Duration (days, hours), time of year, time of day, season, recurrent annual event vs first-time event, peak time of attendance
Dynamics	Crowd Type	Gender mix, age mix, families, disabilities, special populations
	Crowd behavior	Density, activity levels, queuing, movement, behaviour Predispositions, motivations, crowd movement, and flow
Design	Protective Factors	Crowd resilience, health promotion, illness prevention, police/security onsite
	Special Hazards	Climate, weather conditions, road/rail traffic, obstacle course, infectious disease exposure, alcohol and drug use, mosh pits, fireworks
	Onsite Health Services	First aid only, higher level of care

Table 2-8: Past incidents at the Grand Mosque (Al-Masjid Al-Haram)

Holy site/ Incident type	Past incidents at The Grand Mosque (Al-Masjid Al-Haram)	Causes of deaths
Major (death)	September 2015, 107 deaths at Haram (Alqahtani et al., 2017)	Collapse of a crane
Middle (injury)	September 2015, 200 injuries at Haram, from the collapse of Crane (Alqahtani et al., 2017)	
Minor (lost)	<ul style="list-style-type: none"> • 2006, 2500 lost at Haram (Paeveen and Aldhlan, 2016) • 2011, 30.000 lost at Haram and Hajj holy sites (Amro & Nijem, 2012; Paeveen and Aldhlan, 2016) • 2013, 7998 lost cases (Paeveen and Aldhlan, 2016) 	

Table 2-9: Past incidents at Mina city

Holy site/ Incident type	Past incidents at Mina City and Aljamarat Bridge	Causes of deaths
Major (death)	September 2015, 769 deaths (Khan and Noji, 2016; Alqahtani et al., 2017)	Unknown reasons caused a stampede at crossing of street 204 and 223 at tents city, Mina (Khan and Noji, 2016; Alqahtani et al., 2017)
	January 2006, 346 deaths (Khan and Noji, 2016; Alqahtani et al., 2017)	Some pilgrims were stumbled over and caused stampede for arriving pilgrims at the eastern access ramp (Khan and Noji, 2016; Alqahtani et al., 2017)
	February 2004, 251 deaths (Alaska et al., 2016; Khan and Noji, 2016; Alqahtani et al., 2017)	Unorganised pilgrims at the bridge carrying their luggage and belongings. They caused stampede for the crowd's movements on the bridge (Alaska et al., 2016; Khan and Noji, 2016; Alqahtani et al., 2017)
	February 2003, 14 deaths (Aljohani, 2015; Alaska et al., 2016; Alqahtani et al., 2017)	Unknown reasons caused a stampede at Aljamarat Bridge during the ritual of stoning the devil (Aljohani, 2015; Alaska et al., 2016; Alqahtani et al., 2017)
	March 2001, 35 deaths (Imam and Alamoudi, 2014; Alaska et al., 2016; Alqahtani et al., 2017)	Unknown reasons caused trampling at Aljamarat Bridge during stoning the devil (Imam and Alamoudi, 2014; Alaska et al., 2016; Alqahtani et al., 2017)
	April 1998, 119 deaths (Aljohani, 2015; Alaska et al., 2016; Alqahtani et al., 2017)	Panic, which caused trampling and falling pilgrims during the stoning ritual (Aljohani, 2015; Alaska et al., 2016; Alqahtani et al., 2017)
	April 1997, 343 deaths (Khan and Noji, 2016; Alqahtani et al., 2017)	Cooking gas canisters explosions that caused fire at tents city in Mina (Khan and Noji, 2016; Alqahtani et al., 2017)
	April 1994, 270 deaths (Imam and Alamoudi, 2014; Alaska et al., 2016; Aljohani, 2015; Khan and Noji, 2016; Alqahtani et al., 2017)	Crowd waves which crushed the crowds on the bridge (Imam and Alamoudi, 2014; Alaska et al., 2016; Aljohani, 2015; Khan and Noji, 2016; Alqahtani et al., 2017)
	July 1990, 1426 deaths (Imam and Alamoudi, 2014; Aljohani, 2015; Khan and Noji, 2016; Alqahtani et al., 2017)	Stampede inside Alma'aisim tunnel to Haram, due to failed ventilation (Imam and Alamoudi, 2014; Aljohani, 2015; Khan and Noji, 2016; Alqahtani et al., 2017)
Middle (injury)	September 2015, 1278 injuries at crossing of street 204 and 223 at tents city, Mina (Alqahtani et al., 2017)	
	January 2006, 289 injuries from a stampede at Aljamarat Bridge during the ritual of 'stoning the devil' (Alqahtani et al., 2017)	
	February 2004, 244 injuries, from a stampede at Aljamarat Bridge during the ritual of 'stoning the devil' (Alqahtani et al., 2017)	
	April 1998, 188 injuries, from trampling at Aljamarat Bridge (Alqahtani et al., 2017)	
	April 1997, 1500 injuries, fire at tents city in Mina (Imam and Alamoudi, 2014; Khan and Noji, 2016; Alqahtani et al., 2017)	

Minor (lost)	2011, 30,000 lost cases at Haram and Hajj holy sites (Amro & Nijem, 2012; Paeveen and Aldhlan, 2016)	
--------------	--	--

Table 2-10: Past incidents at Arafat and Muzdalifah

Holy site/ Incident type	Arafat	Muzdalifah
	Past	Past
Minor (lost)	2011, 30,000 lost at Haram and Hajj holy sites (Amro & Nijem, 2012; Paeveen and Aldhlan, 2016)	2011, 30,000 lost at Haram and Hajj holy sites (Amro & Nijem, 2012; Paeveen and Aldhlan, 2016)

Chapter 3

Chapter 3 : Modelling Mass Crowd Using Discrete Event Simulation: A Case Study of Integrated Tawaf and Sayee Rituals During Hajj²

Abstract

Hajj is a mass gathering event that takes place annually in Makkah, Saudi Arabia. Typically, around three million people participate in the event and perform rituals that involve their movements within strict space and time restrictions. Despite efforts by the Hajj organisers, such massive crowd gathering and movement cause overcrowding related problems at the Hajj sites. Several previous simulation studies on Hajj focused on the rituals individually. Tawaf, followed by Sayee, are two important rituals that are performed by all the pilgrims at the same venue on the same day. These events have a strong potential for crowd buildup and related problems. As opposed the previous works in the literature, in this chapter we study these two events jointly, rather than separately. We use ExtendSim, a Discrete Event Simulation tool, to integrate the Tawaf and Sayee rituals into one model. The validated model was applied to a wide range of scenarios where different percentages of pilgrims were allocated to the various Tawaf and Sayee areas. The effect of such allocations on the time to complete Tawaf and Sayee indicate strategies for managing these two key Hajj rituals.

3.1. Introduction

Mass Gathering (MG) events involve participation of more than 1,000 people in one site at the same time (Al-Tawfiq et al., 2016) for a specific purpose and for a finite duration (Memish et al., 2012). MG events can be religious (e.g., Hajj); cultural (e.g., large music concerts); sporting (e.g., the Olympics and FIFA World Cups); or political (e.g., processions and rallies or social riots) (Mahmood et al., 2017). Because of the large number of attendees, MGs pose many challenges such as crowd management, security and emergency readiness (Memish et al., 2012). If these challenges are not well managed, MGs can result in adverse outcomes, including spread of diseases, crashes, stampedes, traffic incidents, fires, leading to injuries and even fatalities (Memish et al., 2012).

Hajj, the pilgrimage to Makkah in Saudi Arabia, takes place at several holy sites every year between 8th and 12th of Dhulhijjah, the 12th month in the Islamic (lunar) calendar (Yamin and Albugami, 2014). With a

² This chapter was published in IEEE Access.

crowd of up to three million people comprised of Muslims from all over the world, Hajj is the largest annual MG globally (Tunasar, 2013; Osman and Shaout, 2014; Basalamah, 2016; Khwaja, 2017; Felemban et al., 2020). With an already large and ordinarily increasing numbers of pilgrims each year, Hajj authorities will continue to face bigger challenges, primarily relating to the safety and security of pilgrims (Fourati et al., 2017). Given the uniqueness of the event, the complexity of the planning associated with Hajj, its impacts (Ahmed and Memish, 2020), and the anticipation that Hajj attendance will increase post-COVID19 pandemic, a rigorous and integrated study of Hajj from a crowd management perspective is timely and essential.

Hajj rituals are performed at several sites during the five days within specific time windows. It requires all pilgrims to move from one site to another by bus, train, or on foot (Yamin and Albugami, 2014; Rahman et al, 2017).

Past studies of Hajj have focused on individual rituals. However, the rituals are closely linked, and involve mass movement of pilgrims from one site to another in a fixed and short time period. Thus, congestions are not only at individual sites, but also between sites and rituals.

This chapter focuses on the two rituals performed in the Grand Mosque (GM) during Hajj, on the 3rd day of Hajj: Tawaf Al-ifadah (walking in a counter-clockwise direction seven times around the Ka'aba); and Sayee (pilgrims walk and/or run seven times back and forth) between the two hills of Al-Safa and Al-Marwah, close to the Tawaf area (Felemban et al, 2020).

The objective of our work is to simulate and validate the real Hajj data in various crowd conditions, assessing to what extent capacity and behavioural aspects contribute to crowding and congestion within the Grand Mosque area. Whereas many scholars focused on a single ritual, this research combines two of the most demanding rituals during Hajj, completed within the confines of the GM and with the potential to affect each other.

We use a Discrete Event Simulation (DES) software as a tool to model and simulate the integrated Tawaf and Sayee rituals at normal and evacuation situations. After validating the models, we developed scenarios to study and evaluate the effect of changes in pilgrim distributions at the GM. Given the features of Hajj events (large mass size, geographical setting, time restrictions and annual recurrence of the event), a comparison with other MG events may not be appropriate. Yet, practical solutions we offer here could be applicable to other mass gathering events (e.g., music festivals, Olympics).

The rest of this chapter is structured as follows. Section 3.2 presents a literature review on Hajj, crowd models and simulation. Section 3.4 details the data resources and methodology. Section 3.5 describes the design and implementation of Tawaf and Sayee in ExtendSim. Section 3.6 describes how the simulation models for Tawaf and Sayee rituals were validated and the development of various scenarios for these rituals. In Section 3.7 we discuss the study results and the implications of the scenarios. The chapter concludes with Section 3.8 providing general insights from the modelling exercise, discussing limitations and recommendations for future work.

3.2. Literature Review

3.2.1. Hajj characteristics

Hajj consists of complex and intense activities (rituals) in a prescribed sequence (Yamin and Albugami, 2014; Fourati et al., 2017). The planning of pilgrim movements and transport from one site to another during the event is an enormous task (Fourati et al., 2017; Felemban et al, 2020). Strictly marked territorial boundaries of the specific Hajj sites limit the capacities of the sites. For instance, the areas for Tawaf (called Mataf) and Sayee each accommodate only tens of thousands of persons at any one time. This is only one of the indicators of these challenges, given that around three million pilgrims need to perform these two rituals on the same day in sequence (Haghighati and Hassan, 2013). Osman and Shaout (2014) mention additional reasons that make Hajj crowd management a ‘tough task’: pilgrims come from all over the world and have different backgrounds, languages and cultures, which is often reflected in their behaviours during Hajj.

Pilgrim groups are managed by Hosting Agencies called Mutawif or National Establishments. There are eight establishments: Locals; Arabic Gulf; Iran; South East Asia (SEA); Southern Asia (SA); Africa; Arabs; with the final establishment comprising Turkey, Europe, Australia and America (TEAA) (Alluhaidan and Alredhaimain, 2016). Each establishment has clearly assigned accommodation at the Hajj sites and scheduled times for rituals (Al-Kodmany, 2013). Pilgrims are organised into groups (of usually 250 pilgrims) with a guide (Haase et al. (2016). The guides are in charge of their groups throughout the whole Hajj, instructing them on the rules, providing the schedule of activities, leading the groups through movements (following dedicated routes and means of transport), and monitoring the progression of rituals (Al-Nabulsi and Drury, 2014). When

performing the sequence of activities, the whole group must slow or stop the progression of an activity to accommodate the needs of the group members. Many pilgrims do perform the Hajj rituals independently of their group, on their own and/or with their family and friends. Nonetheless transport and accommodation of pilgrims are organised by their Hajj groups.

3.2.2. Crowd management

Crowd management or systematic planning aimed at optimally managing the movements and assembly of people (Fourati et al., 2017) is an evolving field of interest for specialists in computing, health and police enforcement. Alabdulkarim et al. (2016) described crowd management as: “...a practice that is used to control crowd events before, during, and after events, which include dealing with all elements of an event such as people, sites, facilities, data and technology” (p.251).

Hajj provides a unique case study of crowd management, as it involves the management of a very large number of pilgrims gathered at the same time and place (Al-Kodmany, 2013). Inadequate crowd management can lead to high levels of crowd density and overcrowding, which in turn may have deleterious effects on participants’ safety (Al-Nabulsi and Drury, 2014). As indicated, the outcomes range from minor (getting lost), to moderate (injuries, heat exposure) and major (crushing disasters, deaths) (Yamin and Albugami, 2014; Alabdulkarim et al., 2016; Osman and Shaout, 2014; Fourati et al., 2017; Rahman et al., 2017; Owaidah et al., 2019; Felemban et al., 2020). These incidents are attributed to human bottlenecks, heavy crowds, and unsuccessful crowd movement control (Mlybari et al., 2016; Alaska et al., 2016; Fourati et al., 2017; Owaidah et al., 2019). More details about previous Hajj incidents can be found in Owaidah et al. (2019). In addition to overcrowding at Hajj sites, problems with pilgrim movements and transport (Shalaby et al., 2013) could lead to uncontrollable buildup of crowds for the activities that follow (Yamin and Albugami, 2014).

3.2.3. Crowd modelling

Hajj requires substantial prior planning using various possible scenarios (Bahurmoz, 2006; Khwaja, 2017). Such planning, achieved by using crowd modelling and simulation, plays a vital role in anticipating and

preventing crowd evacuation problems before they occur (Mahmood et al., 2017; Ochoa et al., 2017). Modelling (including simulation) offers many benefits: developing prior arrangements; improving crowd and transport management; identifying crowded spots and traffic bottlenecks; and investigating transitions from normal to evacuation scenarios. In addition, using crowd modelling helps to investigate why, where, when, and how crowds move and leave an event or venue. Crowd modelling assists modellers and practitioners to develop safe and robust prior planning for crowd management (Haghighati and Hassan, 2013).

Modelling efforts in the literature have focused on four types of dangers associated with crowds in extreme conditions: trampling and crushing at religious sites (e.g., Hajj event); trampling and crushing on ships at sea or waterways; crushing during massive concerts; and crowd trampling during natural disasters (earthquakes, floods, avalanches or landslides) (Ochoa et al., 2017). However, crowd modelling and simulation prior to an event can replicate scenarios of safety in risk-free, low cost, time-independent and casualty-free experimental environments. For example, modellers can gain insights into the causes of overcrowding and compare performances of various design alternatives (Mahmood et al., 2017).

The following section reviews previous studies on modelling and simulating the rituals of Tawaf and Sayee.

3.2.4. Crowd modelling and simulation for Hajj events

Owaidah et al. (2019) presented a systematic review of crowd modelling and simulation models, especially those applied for Hajj. They concluded that simulation (DES, Agent Based Models, ABM) combined with Support Vector Machines (SVMs) or other models is the prevailing approach. Crowd modelling and simulation for Hajj event is one of the significant technologies that is used the planning processes of Hajj crowd management (Felemban et al, 2020). Here we briefly present some of the key literature relevant to Tawaf and Sayee.

Haghighati and Hassan (2013) investigated the effect of various crowd problems during Tawaf, with the aim of improving the pilgrim movements around the Ka'bah and reducing the congestion inside the Grand Mosque. Their simulation was conducted using a DES model developed in ARENA, considering the pilgrims as discrete units entering the system, moving through components, and then exiting the system. Pilgrims had

specific attributes (e.g., gender, speed, and size) and were generated and 'stored' in queues. They then moved around the Ka'bah seven times in an anticlockwise route, and upon reaching the finishing line, left the Tawaf area for Sayee. The movement rule enabled each entity to walk in paths near to the Ka'bah whenever free space was available. The authors suggested using scheduling, spiral paths, and clear separation of pilgrim groups during Tawaf to reduce the average time for completing this ritual.

Abdelghany et al. (2016) developed a hybrid simulation-assignment modelling framework, which integrates two layers. The first layer is a network layer, representing the study facility, enabling the pilgrims/entities to plan their routes, while performing their activities. The second layer is a cellular automata (CA) model, which describes each movement according to a sequence of cells occupied over time by an entity until reaching the destination. Their study focused on studying crowd dynamics in large-scale pedestrian facilities, to identify congestion at the Mataf. The cell dimension was selected based on the LoS F (7–8 people/m²), which is usually recorded at Hajj during peak hours. They derived pilgrim density and flow rates at different distances from the Ka'aba (e.g., 8 pilgrims/m² around the Ka'aba and decreasing to 4 pilgrims/m² to the surrounding edges/walls of the Tawaf. The model was validated and the results showed a low flow rate of about 50 pilgrims/m/s around Ka'aba, but increased further away from it, resulting in a capacity of 40,000 pilgrims/h for the Tawaf. Although this work offers a description of the Tawaf and Sayee areas, it only presents results from the Tawaf area, and does not consider other Tawaf levels or the Sayee.

To understand crowd behaviour, Nasir and Sunar (2016) focused on studying the simulation of pilgrim groups in normal conditions, using a popular technique to simulate large groups, the Social Force Model (SFM), combined with a flocking technique. Their study also focuses on the Tawaf area, and their model was built on Microsoft Visual Studio 2013 and written using the C++ programming language. The model's graphics were made using the Open Graphics Library (OpenGL) and application programming interface (API). The results of simulating 500 agents showed that group members successfully maintained their position and kept close to each other in the crowd. If one of them was behind, the whole group would reduce its speed and wait for the individual to catch-up with the rest of the group. This micro-level study highlighted important details of crowd movement in normal situation in the Tawaf area, but the number of entities modelled does not reflect the actual capacity (40,000 to 50,000 pilgrims/h). This study did not consider where and why the simulated pilgrims may change their speed during Tawaf and how pilgrims can be managed at high-density spots.

Felemban et al. (2017) built a crowd simulation model in MassMotion software to study the crowd's movement patterns around the Ka'aba, including entering and exiting from the Tawaf area, stopping to kiss the Black Stone, and slowing down at the starting line of each circumambulation. Felemban et al. (2017) analysed the crowd density around the Kaaba and calculated the required total time for completing the Tawaf ritual in high density and less crowded situations. The micro-level simulation enabled recording individual data on the time and location of entering the Tawaf area, the walking distance and average speed of the Tawaf performance and the number of circumambulations completed when the simulation is stopped. However, this study did not report any results of the simulations.

Löhner et al. (2018) presented two SFM models to understand pilgrim motions when the Tawaf area is congested. The first model focused on modelling and simulating the pilgrims at their desired distance to the Ka'aba, while the second model simulated pilgrims getting closer to the Ka'aba where they reach the highest crowd density. The authors used the "PEDFLOW" crowd dynamics simulation tool to build these two models. The parameters included were the geometry of the Grand Mosque, the entry/exit points to and from the Tawaf area, as well as pilgrim characteristics, such as their cultural background and fitness state. The model simulated 32,400 p/h. The simulation results from the first model showed that the pilgrim density was low in the left region of the Ka'aba, where pilgrims are far from the starting line, yet the density of pilgrims increases close to the Ka'aba, as shown by the second model. The authors suggested a self-regulation process whereby "If the density increases too much, the pilgrims move further away from the Ka'aba and the simulation proceeds without problems while still being realistic" (p.530). The study has not mentioned the fitness level of the pilgrims, their age or gender.

Mohamed and Parvez (2019) proposed a Finite State Machine (FSM) based model for modelling and simulating pilgrim movements during Tawaf. In particular, the authors showed that crowding around the Black Stone 'to touch and kiss' could result in aggressive behaviours of the pilgrims, with the elderly and women being excluded from this ritual. Their simulation investigated innovative ways to manage the crowd around the Black Stone by specifying times for various groups, forming dedicated queues, and introducing physical barriers. The authors compared: the average time of pilgrims to complete the Tawaf (with or without kissing the Black Stone and including queuing) and the average time for pilgrims to 'touch and kiss' the Black Stone (including queuing); the average time to perform Tawaf and queuing behind a barrier installed besides the wall

of Ka'aba (the proposed system). They also highlighted the benefits of the physical barrier, which would compel the pilgrims to queue without having to struggle or overcrowd around the Black Stone. However, although the authors specified crowd density as Level of Service (LoS, representing the number of pilgrims/m²), they did not mention the overall number of pilgrims simulated for performing the Tawaf ritual. Their findings led to new measures being adopted at Hajj, using security guards and organising pilgrims to line-up; yet these measures have not been completely successful in preventing overcrowding or managing aggressive crowd behaviour.

Adopting the same SFM technique, Kolivand et al. (2020) simulated pilgrim movements at the Tawaf area more “realistically” by designing a high-density crowd simulation model that accounts for pilgrim characteristics such as gender, walking speed, and grouping and stopping in the crowd. Their simulation results showed that increasing the number of pilgrims/entities leads to frequent stops in the crowd (either slowly or suddenly), because of the interactions with the surrounding pilgrims (overcrowding). The model closely mimicked the average walking speed during the Tawaf 0.35 m/s compared to 0.3267 m/s from collected data, for a number of 45,000 pilgrims. However, the authors have not highlighted the potential bottleneck areas in the Tawaf (where pilgrims stopped).

In conclusion, prior scholarly work considered congestion in the Tawaf area (one of the most challenging aspects of Hajj), focusing on aspects which can change the physical design of the area. The simulations were at micro-level and adopted techniques, such as CA or SFM, well-suited for inter-agent interactions, although most of them presented results on a relatively small scale compared to the real event. Yet, if the aim is to identify planning and management/operation aspects that can be implemented in Hajj (e.g., scheduling the sequence of activities by groups), adopting a macro-level approach (and using for example discrete event simulations) is needed.

3.2.5. Evacuation modelling and simulation for Hajj events

Crowd evacuation simulation is a part of evacuation management, an important field of study to develop evacuation plans (Sarmady et al., 2008). These plans can be executed to avoid crowd incidents at large places such as the GM and for huge events (e.g., Hajj events) (Sarmady et al., 2008). As pilgrim numbers increase every year, studying and modelling pilgrim movements is important to improve Hajj crowd management and

deliver safety during the event (Mohammad et al., 2014). Although many pilgrims are informed and some are trained to perform the Hajj rituals, very few - if any - are trained to react to emergency or evacuation situations (Namoun et al., 2018).

Therefore, due to the complex structures of Hajj sites and buildings, evacuation management deserves more attention by considering different evacuation scenarios at different Hajj locations (Mohamad et al., 2014; Namoun et al., 2018). In addition, although studies have separately examined evacuation from Tawaf (Mohamad et al., 2014) or Sayee (Abdelghany et al., 2010), there is no modelling developing combined Tawaf and Sayee evacuation scenarios. Our approach is to simulate the evacuation of groups of pilgrims from the GM at a more macroscopic level, by considering the group, instead of individual, as a moving unit (Sakour and Hu, 2017).

Halabi (2006) used the Space Syntax Laboratory to identify overcrowding hotspots and to show the spatial movements of the pilgrims during their evacuation from the Tawaf area of the Grand Mosque. They used spatial layouts and visual graph analysis to visualise the spaces inside the GM building. To develop the evacuation processes, Halabi (2006) included several factors to calculate the duration of the evacuation, including the capacity of an area, walking speed and the distances to the exits. Their main findings of the evacuation processes are presented in Table 3-1. LoS E, equivalent to 6p/m², was applied in the evacuation processes, the average speed being 46 m per minute (0.767 m/s), and pilgrim flow being 82 pilgrims/minute/m.

Table 3-1: Halabi (2006) evacuation results

Level of GM	Level capacity (No. Pilgrim)	Number of exits during the evacuation	Total time for evacuation (min)	No. of pilgrims evacuated	No. of groups evacuated
Basement (Tawaf area)	52,800	20	2.15	44,210	176.84
Ground level	142,208	60	13.73	277,938 (135,730 from other levels)	1,111.75
1 st level	91,250	21	7.98	91,250	356
Roof level	96,800	1 30 escalators*	22.36	96,800	387.2

* In this study, we replaced escalators with further distances to the gates.

Halabi (2006) concluded that pilgrims need substantially more time to be evacuated from the GM than was expected. Note that these evacuation processes were tested before the construction of King Abdullah expansion.

Abdelghany et al. (2010) developed a CA framework of the Sayee area at the GM, where the evacuees could make their own decisions (such as exit choice, path choice to the exit, and path updating) to prevent collisions. Two main factors were considered when choosing an exit; the distance to evacuation exits (12 gates) and the congestion around the exits. The evacuation was developed in five experimental sets. The first set investigated the evacuation of 5,000, 15,000 and 25,000 pilgrims, corresponding to LoS of 0.4, 1.2 and 2.0 p/m² respectively. The second set investigated the evacuation under three density values, 100%, 60% and 20% and the 5th set focused on how the congestion awareness (40%, 60%, 80% and 100%, as proportions of the occupied cells) could affect the evacuation process. The main results of Abdelghany et al. (2010) are presented in Table 3-2. Our interest is on the 1st, 2nd and 5th sets (more related to our case study).

Table 3-2: Abdelghany et al. (2010) evacuation results

Set of experiments	The main feature of the set			Total evacuation duration (min)
	LoS (p/m ²)			
First set	LoS (p/m ²)	0.4	5,000	9.97
		1.2	15,000	32.10
		2.0	25,000	47.08
Second set	Density at the gate (%)	100	15,000	20.62
		60		19.32
		20		18.88
Fifth set	Congestion perception (awareness) (%)	100	15,000	16.6
		80		18.6
		60		16.1
		40		21.0

Abdelghany et al. (2010) concluded that the evacuation performance (duration) could be improved if pilgrims had knowledge of and were trained on how to choose gates and follow evacuation procedures (such as choose the closest gates or less congested gates).

Recently, Mahmood et al. (2017) developed an ABM in Anylogic to identify, evaluate, and test emergency strategies in crowd evacuation. These strategies were tested in evacuating 10,000 pilgrims from the Tawaf area using 12 gates (Mahmood et al., 2017), as follows.

- Random gate evacuation: selecting any exit, simulating the crowd behaviour in panic.
- Shortest distance: choosing the nearest exits and considering prevention of collision.
- Genetic Algorithm (GA1): generating ‘fit pilgrims’ as a key function in the evacuation processes.

Mahmood et al. (2017) considered the following common factors in the evacuation simulation: population = 10,000 pilgrims; min speed = 1.0 m/s, max speed = 2.0 m/s and most likely speed 1.4 m/s; number of simulation runs = 10. Optimisation reduced the evacuation time from 7.4 min (random gate) to 4 min (when the nearest gate was selected), and to 3.1 min when applying GA.

Mahmood et al. (2017) underlined that the evacuation performance may differ from the presented results if evacuation scenarios simulate large numbers of pilgrims with more physical and behavioural interactions and collision prevention.

3.3. Contribution of the work

This work aims to simulate and validate the real data of Hajj event 2019 in various crowd conditions (normal and emergency), to evaluate the potential changes of pilgrims’ organisation inside the Grand Mosque. Scenarios of different crowd conditions are presented, and to identify the bottleneck spots during the Tawaf and Sayee rituals.

Furthermore, while a number of previous studies focused on modelling and simulating pilgrims on a single ritual at a time and at the individual level, this research combines both Tawaf and Sayee rituals, focusing on the relations between them. We used a DES software, ExtendSim, to focus on the potential implications for planning and managing the pilgrim activities at the Grand Mosque. This work is based on the validation of joint events (Tawaf and Sayee) and we applied well-established techniques to model crowds at the meso/macro level, to emphasise that infrastructure and behavioural aspects equally contribute to safety and efficient procedures and decision-making during Hajj. The results of sensitivity analysis are presented to identify elements that Hajj authorities may apply to more efficiently manage the crowds at the GM. Based on this analysis, we present some managerial solutions for crowd management at Hajj.

¹ GA is an optimisation technique using evolutionary concepts to choose the best evacuation solution that reduces the overall evacuation time by assigning pilgrims to less crowded exits.

3.4. Data Resources and Methodology

This study uses DES, focusing on Tawaf and Sayee rituals during the 10th of Dullhijjah, simulating both rituals as an integrated activity, in normal and evacuation situations, thus addressing a critical gap in the literature.

We used secondary data collected by the local Hajj authorities in Saudi Arabia and apply a model built in ExtendSim, a powerful platform for DES (Krahl, 2012) developed by Imagine That Inc. (Aurelius and Ingvarsson, 2019). The modelling approach was adapted from Papageorgiou et al. (2009). Figure 1-3 (from chapter 1) illustrates the main steps, which are detailed below.

- Problem definition – clearly identifying the problem to be solved and its causes (e.g., why is there overcrowding at Hajj ritual locations, such as at Tawaf and Sayee areas).
- Model objectives – establishing the goals of the simulation, ensuring that the stated objectives solve the problem identified in the first step. In addition, the main system components are defined and the model inputs are identified. Our objective was to identify the locations that are subject to overcrowding and reduce the pilgrim numbers at these locations.
- Model development – model complexity required to achieve the stated objectives, as well as selecting the appropriate modelling platform. In our case, we have chosen ExtendSim10 for its capabilities and availability within the institution for research and training.
- Model calibration – refers to specifying the main mathematical equations and statistical functions used for building the model and using data to estimate the model parameters. We based our calibration on statistical information from secondary sources (official statistics of pilgrim numbers performing Tawaf and Sayee rituals and counts and durations estimated from video material) as well as previous scholarly work. In addition, given the uncertainties around several inputs, the model was tested with various input ranges e.g., distribution of times, number of services (number of gates, buses, etc.), walking speed of pilgrims, to test the robustness of the model.
- Model validation – using real data to test the model performance. This may involve developing criteria and applying statistical methods to test hypotheses. If the results between the simulation results and real-world data are different, the developer must check and update the model, then repeat this step again. The t-tests and MANOVA we applied indicate validation with 2015-2019 data.

- Scenario testing – developing and testing various scenarios once model validation is confirmed, evaluating the results, and formulating solutions.

3.4.1. Data collection sources

Secondary data were obtained from The Institute of Hajj and Umrah Research and Ministry of Hajj, Makkah city, Saudi Arabia. As shown in Figure 3-1, we combined many different sources to initialise and validate the models, including images and video recording from Hajj 2015, 2016 and 2017, tables and figures from Hajj 2019 operational planning, Hajj Transport Department and The Saudi Car Syndicate Operational Planning. Also included were social media coverage of Hajj daily reports in 2019, and personal experiences and recollections of previous Hajj events by co-authors. These data sources were compared, triangulated, and cross-checked before the model inputs were set, and the results of the simulation were compared with the published statistics of the events and media reports.

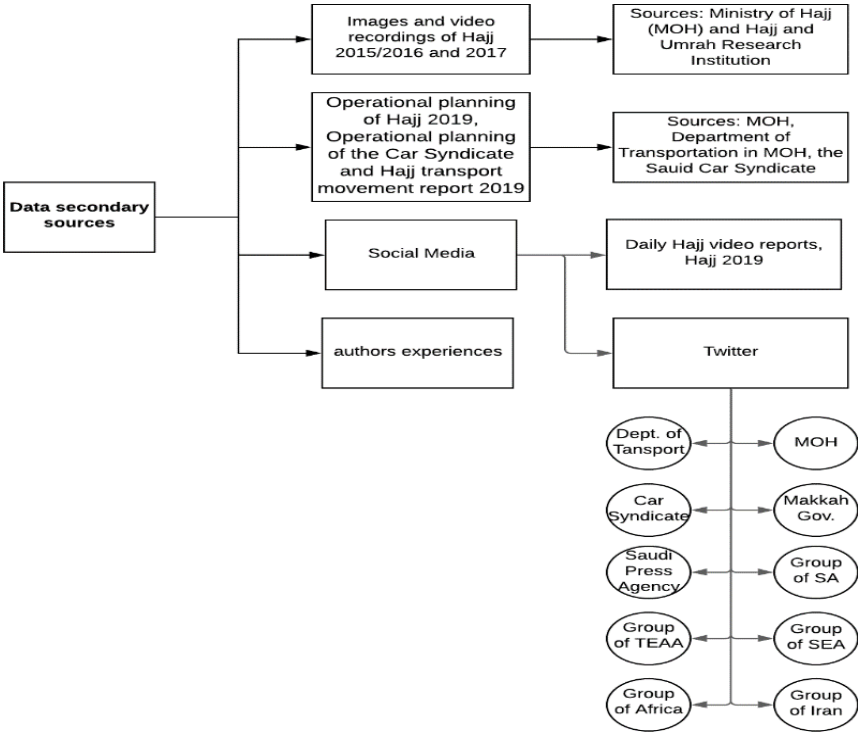

Figure 3-1: Data sources and data formation process

3.4.2. Model development

ExtendSim version 10 (as a DES tool) was selected because it can simulate a variety of systems from simple to very complex stochastic models, which makes it applicable to many different fields such as healthcare, manufacturing, communications, logistics and military operations (Aurelius and Ingvarsson, 2019; Krahl and Nastasi, 2014). The platform implements a graphical interface consisting of many hierarchical blocks and including components that represent the processes in the simulation (Krahl and Nastasi, 2014). Blocks are the main items in ExtendSim, which progresses the items (entities or pilgrims) from one block to another to perform a specific activity (Birgisson, 2009).

3.5. Modelling and simulation implementation

The model presented here refers to the Tawaf and Sayee rituals performed in the GM assuming the pilgrims are already in Makkah. Activities undertaken prior by international and regional pilgrims are not modelled in this simulation. Note that some figures and maps are stored in the institutional repository for better resolution.

3.5.1. Tawaf and Sayee at The Grand Mosque

The Grand Mosque is a large complex area which covers 356,800 m² (Felemban and Basalamah, 2011; Al-Nabulsi, 2015; Kurdi et al., 2015), with expansion plans to 1.1 million m² to accommodate up to 2.5 million worshippers at a time (Kurdi et al., 2015). The last expansion, initiated in 2011, was paused in 2015 after a crane accident (which caused 111 fatalities and 394 injuries), but resumed in 2017 (Daye, 2018). The expansion has reached 80% completion and is expected to be finished in 2022 (Al-Salami, 2020). The Tawaf area consists of the following sections (Shuaibu et al., 2015; Algadhi and Still, 2010; Al-Zahrani, 2018).

- Tawaf area around the Ka'aba (or simply Tawaf) has an extended area of 16,185 m² and permits 50,000 pilgrims per hour (p/h) (Tunasar, 2013; Algadhi and Still, 2010).
- Ground level with area 11,778 m² and permits between 10,000 to 25,000 pilgrims p/h.
- Level 1 has an area 10,318 m² and allows between 7,000 to 26,000 pilgrims p/h.
- Roof Level has an area 10,318 m² and allows for 12,000 to 30,000 pilgrims p/h. Capacity on Level 1 and roof levels are different, because of the different pilgrim speeds on these levels.

The Tawaf (154 m long and 105 m wide) includes a circular area (Alghadi and Still, 2010), with the Ka'aba in the middle. The walking distances vary between 200 m and 585 m per circle (Sridhar et al., 2015), leading to circumambulation distances between 1.4 to 4.1 km (depending on where it is performed). The overall average level of services (LoS) is 4 pilgrims/m², which is considered high density (Al-Nabulsi and Drury, 2014). However, at certain locations such as the Tawaf, the preferred area by pilgrims (Haghighati and Hassan, 2013), the LoS can reach to 6-8 pilgrims /m² (Al-Nabulsi and Drury, 2014).

To avoid congestion, pilgrims are distributed over the five levels as follows: Tawaf area (73.2%); Ground level (GL) (12.7%); Level 1 (L1) (11.1%); Mobility Reduced area at Level 1 (L1 MR) (2%) and Roof (RL) (1%).

Currently, pilgrims use five major gates to access the GM; Al-Umrah (U), King Fahad (K.F.), King Abdulaziz (K.Az), Al-Marwah (M), and Al-Fatah (F) (Zainuddin et al., 2009) 51. King Abdulaziz gate (K.A.) (bottom of map, Figure 3.3) is the nearest to the beginning line of the Tawaf ritual (Zainuddin et al., 2009) and the most used gate. With the new expansion of the GM, a sixth gate, called King Abdullah Gate (K.A.) (north west of the map), leads directly to the Tawaf area (Al-Salami, 2020). GM has a total of 179 gates (indicated in blue in Figure 3-2).

Tawaf Al-ifadah is obligatory for Hajj completion (Qurashi, 2018), being a key ritual. Pilgrims arrive at Mina on the 8th of Dhulhijjah and leave for Arafat on the 9th, spending the whole day there. Just before sunset, they leave for Muzdalifah where they spend the night. Usually, pilgrims perform Tawaf after noon on the 10th, after stoning the big Aljamarat pillar, sacrificing an animal and shaving their heads (Felemban and Basalamah, 2011; Khan, 2012; Al-Nabulsi, 2015). Tawaf Al-ifadah needs to be completed within a 48-hour window on the 10th and 11th (Khan, 2012).

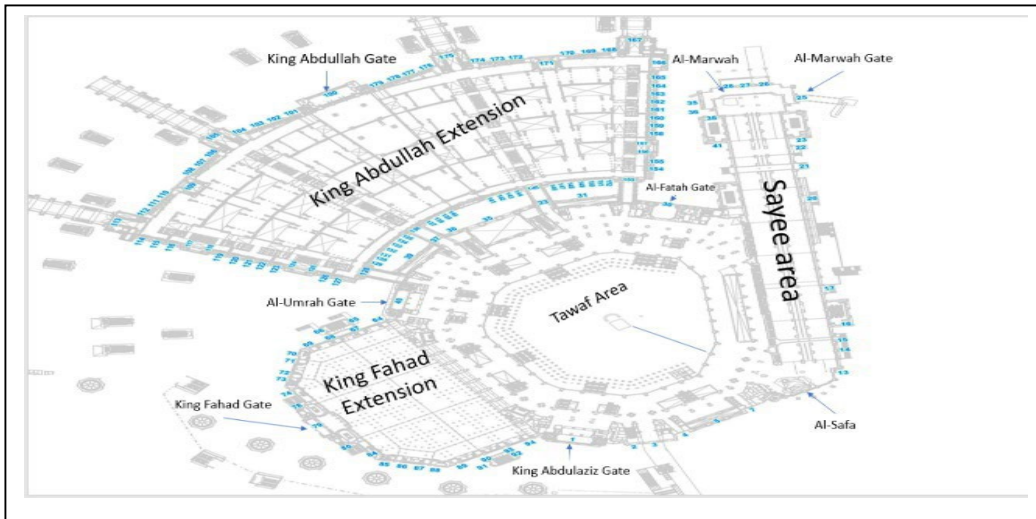

Figure 3-2: The Grand Mosque map (source: The General Presidency of The Affairs of The Grand Mosque and The Prophet's Mosque, 2020)

After performing Tawaf, pilgrims must go to the Sayee area, about 400m away, but still within the boundaries of the GM (Hajj-Umrah-Planner, 2019). The Sayee ritual requires pilgrims to move back and forth between the two hills of Al-Safa and Al-Marwah seven times, starting from Al-Safa (Figure 3.3) (Sridhar et al., 2015; Sakellariou et al., 2014). The Sayee area is about 394 m long and 33 m wide (Sakellariou et al., 2014). Sayee can be performed at any one of five levels, each with an estimated capacity of 50,000 pilgrims and a maximum crowd density during the peak of Hajj of about 4 pilgrims/m² (Abdelghany et al., 2010). The highest allocation is for the Ground-level (57.5%), which is a continuation of the Tawaf area. Pilgrims are distributed to other Sayee levels as follows: Basement level (BL) (15.5%); Level 1 (L1) (22%); Mobility Reduced area at Sayee first level (L1 MR) (1%); Level 2 (L2) (3%) and Level 3 (L3) (1%). There is no strict requirement as to which establishments to perform Sayee at each level, but pilgrims' preferences match the percentages above.

Figure 3.4 shows the percentage of pilgrims and the corresponding LoS for each level of the Tawaf and Sayee areas. For example, when the percentage of pilgrims in the Tawaf area is 30%, the LoS is 2 pilgrims/m², but this increases to 6 pilgrims/m² when the allocation becomes 80%. Correspondingly, the allocation in other areas decreases, resulting in an improved LoS. The most dramatic effect is seen for GL, and L1 and the roof level, given their reduced allocation. Other studies have shown that by maintaining the number of pilgrims in the Tawaf area at a maximum of 50% for all activities (Algadhi and Still, 2010; Al-Nabulsi and Drury, 2014) a better utilisation of infrastructure is achieved and a LoS under 6 pilgrims/m² is ensured (see Figure 3-3).

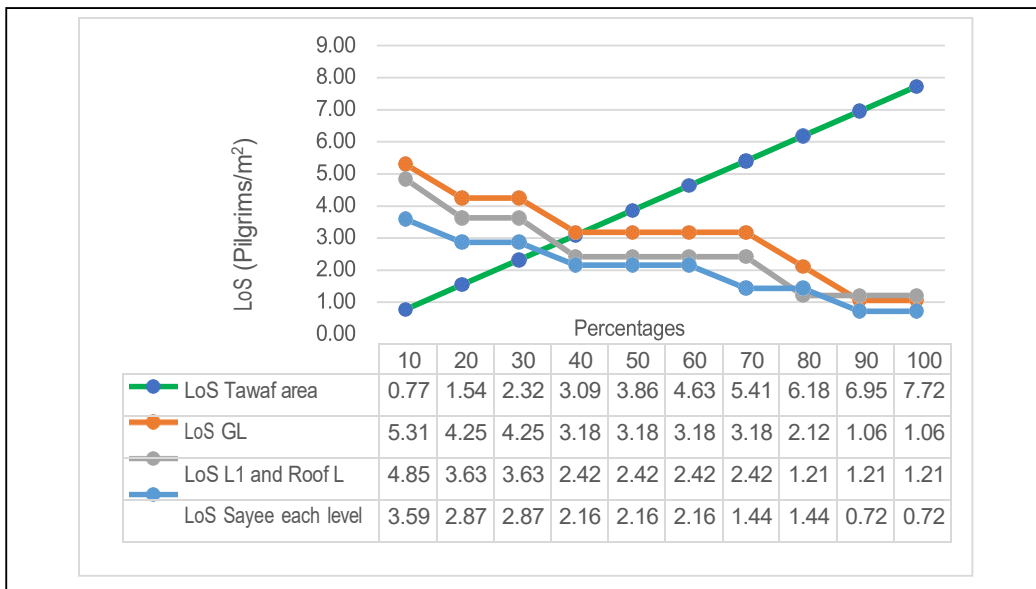

Figure 3-3: LoS depending on the allocation percentages

3.5.2. Tawaf and Sayee simulation

The simulation model in ExtendSim includes sets of hierarchical blocks, each performing a specific activity (Laguna and Marklund, 2013). Table 3-13 (in the appendix) presents the main blocks used in our model along with their functions. An Executive Block (Figure 3-4-A²), located at the top left corner of the model, controls the simulation timing and passage of the pilgrims through the system. Create blocks generate pilgrims, Set blocks assign behavioural characteristics to pilgrims and Activity blocks are used for the duration of the rituals.

² Because the figures are too large, we have uploaded them on <https://cloudstor.aarnet.edu.au/plus/s/vL8gWYIxshnlZXs>

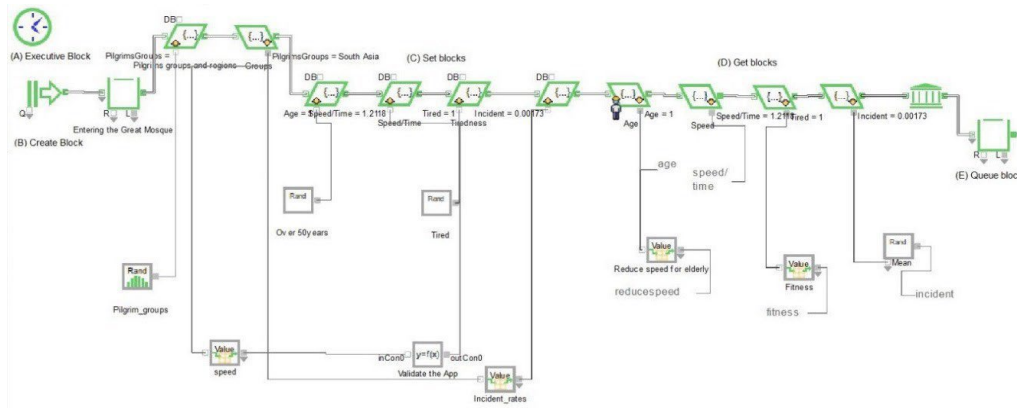

Figure 3-4: (A) Executive Block, (B) Create Block, (C) Set Blocks, (D) Get Blocks, (E) Queue Block.

In the Tawaf and Sayee model (Figure 3-4³), the Create Block (Figure 3-4-B³) generates 12,000 groups of 250 pilgrims each, giving a total of three million pilgrims. Pilgrims enter the Grand Mosque, perform Tawaf followed by Sayee, and then exit the simulation. The following attributes were applied to pilgrims and were incorporated using Set and Get Blocks (Figure 3-4-B, C and D³).

- **Groups and regions:** as percentages of all pilgrims for Hajj 2019.
- **Age:** The available data of pilgrims ages from Hajj 2019, used for validation, was by category (under and over 50). 40% aged between 10 and 50 years and 60% aged 50 years+, each with different fixed fitness levels.
- **Speed:** Speeds vary between 0.8 to 1.46 (m/s) depending on pilgrims' fitness and level of fatigue (three levels assumed - rested, tired and very tired) and are given in Table 3-14 (Appendix). The average walking speed for the ages 10-50 (fit) is around 1 m/s and for elderly pilgrims is 0.83 m/s. Triangular distributions are applied with the average speeds being the most likely speeds. Additional speed adjustment is applied for crowding, when the speed is halved for LoS above 4 people/m².
- **Fatigue:** This attribute is related to the Speed attribute. After walking for a period of time, pilgrims' level of energy is assumed to change from rested to tired and their speed drops by a factor of 1.11. This further changes from tired to very tired and their speed decreases by a factor of 1.25 compared to rested. These average levels were established based on the video material, but were also tested as a part of the sensitivity analysis.
- **Incident rates:** Bianchi (2017) reported that eight countries from four different continents faced major incidents at Hajj events between 2002-2015. Percentages of incidents were calculated by geographical groups (Iran, Indonesia, Pakistan, Bangladesh and India together under Asia; Turkey was combined with Europe;

³ Figures 3-4A to 5E stored on: <https://cloudstor.aamnet.edu.au/plus/s/vL8gWYIxshnIZXs>

Nigeria under Africa, and Egypt under Arab countries). The incident rates for these groups (Table 3-15 in the Appendix) vary from Iran = 0.06%, Europe = 0.07% to South Asia = 0.53%).

Pilgrim arrivals are scheduled by the Hajj authorities. For example, Hajj authorities allow a time window of six hours for each group to arrive at the Grand Mosque from Mina city on the 10th, perform Tawaf and Sayee then exit and return to Mina. The arrival rates largely follow a Poisson distribution.

The distribution of the pilgrims in the model was based on the following statistics:

- Africa 7.11% (12 pm – 6 pm on the 10th)
- Arabs 15.7% (3 pm – 9 pm on the 10th)
- South-East Asia 11.65% (7 pm – 1 am on the 10th)
- South Asia 27.62% (10 pm – 4 am on the 10th)
- Iran 3.4% (11 pm – 5 am in the 10th)
- TEAA 9.28% (1 pm – 7 pm on the 10th)
- Locals 24.03% (7 am on the 10th – 1 pm on the 11th)
- Arabic Gulf 1.21% (12 pm – 6 pm on the 11th)

The peaks or potentially congestion-generating periods may occur when multiple groups are allowed to enter the GM at the same time.

Upon their arrival, pilgrims are allocated one of the five main gates of the GM, with the percentage allocations in the model:

- King Abdullah gate 10%;
- Al-Marwah gate 10%;
- Al-Fatah gate 15%;
- Al-Umrah gate 15%;
- King Fahad gate 20%;
- King Abdullaziz gate 30%.

Before performing the Tawaf, the pilgrims queue at their allocated gate (Figure 3-4-E³). Once they are admitted, they walk through the gate until reaching the Tawaf area, represented by Activity blocks (Figure 3-5-A⁴). Tawaf is performed at one of the five levels, depending on the entrance allocation (Figure 3-5-B⁵). The walking duration is calculated using Equation blocks (see Figure 3-5-C⁶) and considers the distance from

⁴ <https://cloudstor.aamet.edu.au/plus/s/0P0NbkODwRS9J85>

⁵ <https://cloudstor.aamet.edu.au/plus/s/2gydU1ZOq7ISjMo>

⁶ <https://cloudstor.aamet.edu.au/plus/s/eJPjYkZ9s9Ejjco>

the gates to the Tawaf ritual areas (see Table 3-16 in the Appendix). An example calculation is given below in [Equation 3-1], where ReduceSpeed (Age) and Tired (Fatigue) are factors that reduce the walking speed depending on the Age (and thus fitness) and fatigue level of the pilgrim. We have assumed that in the case of an incident, the walking time will double.

Entering	Equation (time in min)
from King Abdulaziz Gate (d=190 m)	if(Incident==0) $\text{Walktime} = \frac{\text{Distance} \times 1}{60 \times [\text{Speed} \times \text{ReduceSpeed (Age)} \times \text{Tired(Fatigue)}]}$
	Else $\text{Walktime} = \frac{\text{Distance} \times 1}{2 \times [2 \times \text{Speed} \times \text{ReduceSpeed (Age)} \times \text{Tired(Fatigue)}]}$

Equation 3-1

After arriving to the Tawaf areas, pilgrims may need to queue and face a delay as they merge with the people already performing Tawaf (Figure 3-5-B⁷). A different equation block is used to calculate the duration of circumambulation, depending on the distance from the Ka'aba and level where it is performed, as well as the congestion conditions (Figure 3-5-D⁸). After pilgrims finish Tawaf, they walk to the Sayee area (Figure 3-5-E⁹). The walking duration is calculated in a similar manner to Equation 3-1.

⁷ <https://cloudstor.aamet.edu.au/plus/s/2gydU1ZOq7ISjMo>

⁸ <https://cloudstor.aamet.edu.au/plus/s/iQpw4OSUeLzqJsW>

⁹ <https://cloudstor.aamet.edu.au/plus/s/vHxslpFusbOyjxi>

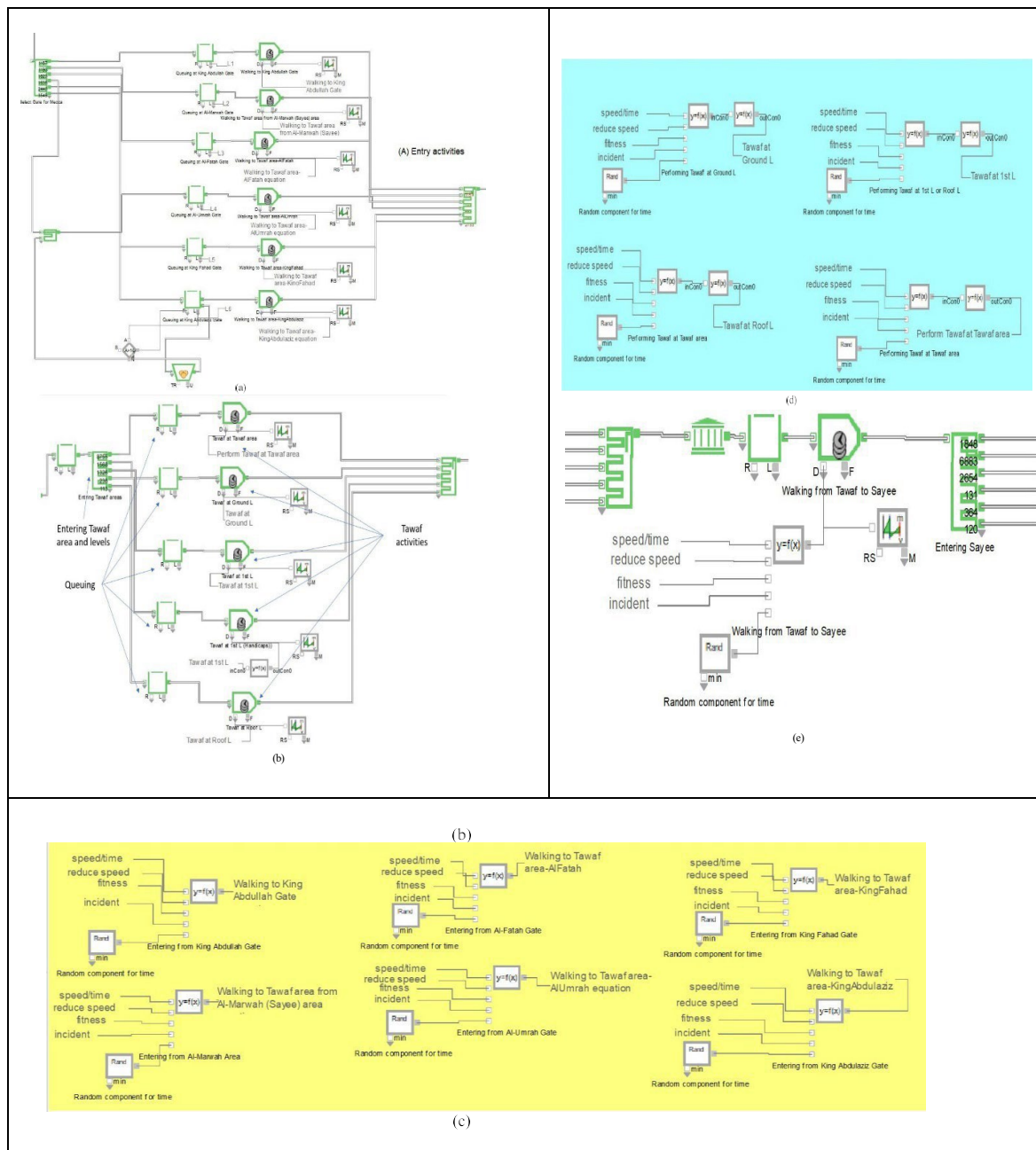

Figure 3-5: A: Entry activities. B: Tawaf activities. C: Entry equations. D: Tawaf equations. E: Walking activity from Tawaf to Sayee.

Pilgrims may again queue and be delayed while joining other pilgrims performing the Sayee ritual (Figure 3-6-A¹⁰). Completing the Sayee marks the end of rituals in the Grand Mosque and pilgrims exit the mosque through one of the gates. This is represented in the simulation by using the Exiting activities (Figure 3-6-B and C¹¹). Equation blocks are also used to calculate the duration of Sayee, accounting for the distance between

¹⁰ <https://cloudstor.aamet.edu.au/plus/s/d2jii8zt0SSej3F>

¹¹ Figures 7B to 7D stored on: <https://cloudstor.aamet.edu.au/plus/s/zILokNKKXLn7rh9>

the two hills and the walking time to exit as a function of the gate (see Equation 3-1). The Plotter Block (Figure 3-6-D¹¹) provides the cumulative count of pilgrims completing both rituals over time (models made available in the institution repository).

The initial results of the simulation indicate that it takes 30 hours for the 12,000 groups (3,000,000 pilgrims) to complete both the Tawaf and Sayee rituals.

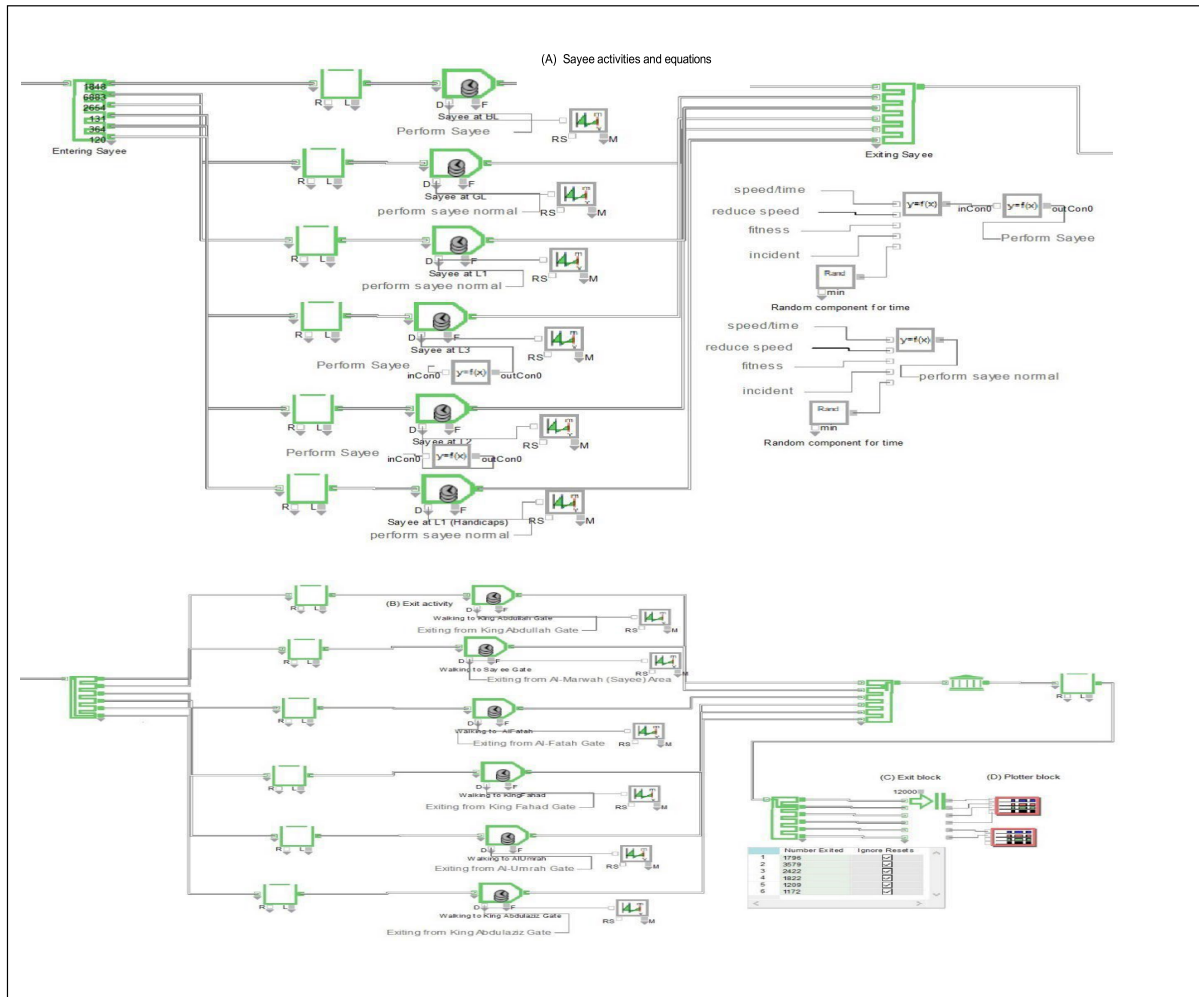

Figure 3-6: (A) Sayee activities and equations. (B) Exit activities, (C) Exit Blocks, (D) Plotter Blocks.

3.6. Simulation Results

The model was run 30 times and the results were compared against statistics based on the real data (Table 3-3, Table 3-4 and Table 3-5). The inputs were stochastic and triangular distributions were assumed for activity durations; this means that the results are also stochastic. The use of triangular distributions is a potential limitation; further research could compare with other types of distributions for durations.

3.6.1. Model validation

In 2019, a total of 2.6 million pilgrims performed Hajj, while our model admitted 3 million pilgrims. Nonetheless, the simulation results compare very well with the real data. The similarities indicate some potential reserve capacity in the system.

Table 3-3 shows the statistics for entering and exiting activities. The simulation results for the percentage of pilgrims entering through each gate matches closely with real data. Similarly, the actual walking times from the gates to Tawaf on entry, and to the exit gates on completing Sayee, show no statistically significant differences between simulation results and real data.

Table 3-3: Validation of arrivals and exit (statistics)

Main Gates	Entering Activity (Average over 30 hours)			Exiting Activity (Average over 30 hours)		
	Real Data 2019 (%) (*)	Sim. results (average throughput %)	Diff. (%)	Real Data 2019 (%)	Sim. results (average throughput %)	Diff. (%)
King Abdulaziz	30	30.26	0.26	10	10.80	0.80
King Fahad	20	20.57	0.57	10	9.57	-0.43
Al-Umrah	15	14.65	-0.35	15	15.38	0.38
Al-Fatah	15	15.10	0.10	20	19.50	-0.50
Al-Marwah (Sayee)	10	9.36	-0.64	30	29.85	-0.15
King Abdullah	10	10.06	0.06	15	14.90	-0.10
Main gates	Average walking time to Tawaf (min) (**)	Avg. Sim. walking time to Tawaf (min)	Diff. (sec)	Avg. walking time to main gates (min)	Avg. Sim. walking time to main gates (min)	Diff. (sec)
King Abdulaziz	3	2.88	-7	9	8.9	-6
King Fahad	5	4.82	-11	10	9.63	-22
Al-Umrah	4	3.85	-9	7	6.75	-15
Al-Fatah	5	4.82	-11	3	2.88	-7
Al-Marwah (Sayee)	8	7.72	-7	1	0.97	-2
King Abdullah	8	7.07	-20	5	4.82	-11

Note1: Sourced from: (*) data from the lead author, while (**) Avg Walking time to Tawaf (min) (The General Presidency of The Affairs of The Grand Mosque and The Prophet's Mosque, 2020) 59

Note 2: The selection of the gate is based on the geographical location (the closest gate to enter Tawaf is the furthest from Sayee site).

Note 3: Simulation results represent Avg. of 30 simulation runs.

Table 3-4 and Table 3-5 provide the percentage of pilgrims and durations for Tawaf and Sayee respectively. The differences between the simulations and real data for the percentage of pilgrims by gate and levels are under 1%, giving confidence in the veracity of the model. The LoS at Tawaf area and the Ground level of Sayee confirm that they are the most crowded areas, which could result in crowd incidents. From Table 3-4, at peak times the Tawaf area records an LoS of 6 p/m². The LoS for GL, L1 and roof level are lower, with a maximum of 2 pilgrims/m² at peak time. In addition, Tawaf durations show an average of 45 min at the Tawaf area, 42 min at GL, 48 min at L1 (duration of going to the next level is included in

the models), 40 min at L1 MR and finally 55 min at the roof level. The General Presidency of The Affairs of The Grand Mosque and The Prophet’s Mosque (2019) provides allocation by levels for Sayee (Table 3-5). Our results indicate slightly shorter average times and better LoS, even with the larger number of pilgrims for 2019 (three million). The model closely mirrors the percentages of pilgrims undertaking the Sayee ritual at various levels. The longest times for performing Sayee are at levels 2 and 3 (on average 69 min). The most crowded area is the Ground level (6 p/m² at peak times), as this level accommodates nearly 60% of the pilgrims. The LoS is under 2 pilgrims/m² at peak times for Basement level and L1 (Table 3-5). The lower durations for the activities and better level of service suggest potential reserves of capacity in the system, able to accommodate over 2.6 million pilgrims.

Table 3-4: Tawaf Activity – Validation

	Real Data 2019	Sim. results	Diff.	Real Data 2019	Sim. Results (min)	Diff. (above 1h) (min)	Real Data 2019	Sim. results
	Percentages of pilgrims/30h (%) (*)			Duration of activity (**)			LoS pilgrims at peak times (p/m ²) (*)	
Tawaf area	73.2	72.56	-0.64	1 – 3 hours (**)	45.72	-14.28	4-8	6
Ground level (GL)	12.7	13.57	0.87	Normal situation: 15-20 min Crowd situation: 50 min (***)	42.18	-17.82	1-8	2
Level 1 (L1)	11.1	11.07	-0.03		48.2	-11.80	1-8	2
Mobility Reduced (MR) restriction at L1	2	1.9	-0.10		40.0	-20.00	1-2	1
Roof level	1	0.9	-0.1		55.43	-4.57	1-8	1

Note: Sources: * Tawaf distribution (The General Presidency of The Affairs of The Grand Mosque and The Prophet’s Mosque, 2019); ** Alshammari and Mikler (2015); *** Hajj and Umrah Planner (2019).

Table 3-5: Sayee Activity – Validation

	Real Data 2019	Sim. results	Diff.	Real Data 2019	Sim. Results (min)	Diff. (above 1h) (min)	Real Data 2019	Sim. results
	Percentages of pilgrims/30h (%) (*)			Duration of activity (**)			LoS pilgrims at peak times (p/m ²) (*)	
Basement level (BL)	15.5	15.24	-0.26	1 – 3 hours (**)	55.33	-4.67	1-4	2
GL	57.5	57.57	0.07	Normal situation: 15-20 min Crowd situation: 35/40 min (***)	44.28	-15.72	4-8	6
L1	22	22.28	0.28		44.28	-15.72	1-4	2
Mobility Reduced (MR) restriction at L1	1	0.97	-0.03		44.28	-15.72	1-2	1
L2	3	2.84	-0.16		69.18	9.18	1-4	1
L3	1	1.1	-0.1	69.18	9.18	1-4	1	

Note: * Sayee distribution (The General Presidency of The Affairs of The Grand Mosque and The Prophet’s Mosque, 2019); ** Alshammari and Mikler (2015); *** Hajj and Umrah Planner (2019).

3.6.2. Tawaf and Sayee scenarios

Problems due to overcrowding at Hajj sites may be contained and crowd incidents could be prevented by efficient crowd management, including sufficient prior planning through crowd modelling and simulation, infrastructure improvements, deployment of more security officers and better use of information technology (Owaidah et al., 2019).

Currently, Hajj evacuation procedures are planned and carried out by the Saudi Civil Defence (SCD) (Okaz, 2018). SCD trains and prepares more than 18,000 officers to execute evacuation procedures, using more than 3,000 devices and sophisticated pieces of equipment. They have developed more than 13 possible hazard scenarios for Hajj events, including extreme weather conditions (high temperatures, rain, wind, storm and floods), dangers at construction sites (e.g., mosque expansion), fires, falling rocks and crowd hazards.

In this study, we examine conditions for operation changes without incidents [Sections 3.1 to 3.5] and for more likely hazard situations such as extreme heat or storms, which may require halting proceedings, including some rituals, or movement between sites [Section 3.6].

The scenarios in Table 3-6 were tested to estimate their effects on the LoS, as well as the average ritual activity durations and the average queue building at Tawaf and Sayee. These methods could be used as new strategical management options for the event. In addition, all Tawaf and Sayee (normal and evacuation) scenarios were designed and developed according to the Grand Mosque's infrastructure including the new building of the King Abdullah expansion (see Figure 3.3). All these scenarios were replicated 30 times.

3.6.2.1. Developing Tawaf and Sayee Scenarios

Table 3-6 describes the scenarios we implemented in the Tawaf and Sayee model.

Table 3-6: Tawaf and Sayee scenarios

Tawaf and Sayee scenarios	Implementation
Change the allocations for entering and exiting from the main gates (please refer to Table 3-3 columns 3 and 6)	Increasing, decreasing or meeting the allocations. For example: <ul style="list-style-type: none"> • Entering and exiting from only five gates • Closing the nearest entrance gate to Tawaf area (King Abdulaziz gate) • Closing the nearest exit gate from Sayee area (Al-Marwah gate)
Increasing or decreasing the pilgrim numbers at various Tawaf areas (please refer to Table 3-4, column 2)	Increasing, decreasing or meeting the allocations for the five areas. For example, reducing the number of pilgrims in Tawaf area and directing them to areas GL, 1 st and roof levels, to avoid crowdedness at the Tawaf area (less than 6-8 p/m ²).
Increasing or decreasing the pilgrim numbers at various Sayee areas (please refer to Table 3-5, column 2)	Increasing, decreasing or meeting the allocations for the Sayee areas. For example, directing pilgrims from GL to BL, 1 st , 2 nd and 3 rd levels, to avoid crowdedness at the Tawaf area (less than 6-8 p/m ²).
Allocating each group to a certain gate	Each group will enter GM from a certain assigned gate (not randomly), with large groups entering from the gates nearest to Tawaf.
Emergency evacuations from Tawaf and Sayee areas	Choose: <ul style="list-style-type: none"> • Nearest exits for evacuation • Least crowded/ Guided exits (reneing queue) *

* Suggested by Mohamad et al. (2013). In the less crowded/guided exits strategy, the pilgrims will be evacuated using visible exits guided by Hajj officials, which they have better knowledge about The Grand Mosque main entrances and exits.

3.6.2.2. Individual scenarios for one-way sensitivity analysis

In these scenarios, the percentage allocation of pilgrims was changed only at one stage—entry, Tawaf, Sayee, or exit of the model at a time, while the remaining areas used the allocations of the original model. The results indicate that changes in the percentage allocations to gates for entry/exit or Sayee areas do not affect the overall duration of the Tawaf and Sayee rituals (within 30 hours). However, the model is sensitive to the percentage allocation for Tawaf areas and yields the poorest LoS when Tawaf area is closed. A multiple regression model for these scenarios with the number of pilgrims completing the rituals in 30h showed a significant effect of closing areas, as well of the age distribution of the pilgrims, but not of the level of fatigue on (R^2 -adj=0.77, see Table 3-7).

Table 3-7: Regression results (sensitivity analysis)

	B	Beta	t	Sig.	VIF
(Constant)	6,358.598		5.245	0	
Age dummy (over 50)	-1,741.956	-0.085	-1.688	0.092	4.019
Speed (m/s)	394.741	0.034	0.656	0.512	4.235
Tawaf GL	-4,647.51	-0.313	-8.844	0	1.994
Tawaf L1	-9,134.81	-0.626	-16.468	0	2.3
Tawaf MR L1	10,034.88	0.036	1.159	0.247	1.566
Tawaf Roof	-7,073.49	-0.503	-12.228	0	2.689
Sayee basement	6,918.741	0.449	8.743	0	4.206
Sayee GL	5,930.995	0.44	10.404	0	2.843
Sayee L1	6,225.335	0.404	9.002	0	3.209
Sayee MR L1	6,530.219	0.089	3.155	0.002	1.255

The regression model results confirm that lower numbers of pilgrims can be accommodated when the Mataf area is closed and that similar numbers of pilgrims are completing Sayee at each level. Note that speed is not significant in the regression model since Speed and Age (dummy variable) are highly correlated. The main results of these scenarios are presented in Table 3-8.

3.6.2.3. Mixed scenarios

A total of 110 mixed scenarios, where allocations were changed simultaneously in two or more areas, were developed as follows.

- Changing the percentages allocations from 30% to 80% at all Tawaf and Sayee areas;
- Focusing on the most critical areas preferred by pilgrims and combining allocations (e.g., Tawaf area with Sayee GL, Tawaf GL with Sayee L1, Tawaf L1 with Sayee BL and Tawaf Roof L with Sayee L2);
- Changing pilgrim percentages at the King Abdulaziz (KAz.) entry gate, which is the closest gate to Tawaf levels;
- Changing pilgrim percentages at Al-Marwah exit gate, which is the closest gate to exit.

The simulation scenarios were categorised into three groups based on their results: scenarios that simulated all pilgrim groups within the simulation time (30 hours); scenarios that simulated between 9,000 and 12,000 groups; and scenarios that simulated less than 9,000 groups. Some important observations from the results of these scenarios are summarised below (for more details, the results can be found at UWA repository¹² and all the Grand Mosque main gates leading to Tawaf, including King Abdullah Gate were tested in the scenarios).

- Closure of Tawaf area, with the ritual performed at other levels, or underutilising the Tawaf area has the most negative impact on the completion of the rituals (only about 75% of the pilgrim groups completed the rituals within 30 hours).
- When critical gates to Tawaf area and Sayee were closed, delays occurred in completing the rituals and in evacuation.

¹²<https://cloudstor.aarnet.edu.au/plus/s/ZNprMWzZqNULBYY>

- When Tawaf area was closed or received 20% to 40% of pilgrim groups, 9,000 to 11,000 groups completed the rituals within 30 hours.
- When Tawaf area was closed together with Sayee L3, only 5,000 to 9,000 groups completed the rituals within 30 hours.
- When Tawaf GL and Roof level were closed together with three exit gates, less than 10,000 groups completed the rituals within 30 hours.
- When two Sayee levels and two exit gates were closed, 9,000 pilgrim groups completed the rituals within 30 hours.
- When Tawaf area and Sayee GL received 40% to 60%, but two levels from each area were closed, up to 10,000 groups completed the rituals within 30 hours.
- If the proportion of pilgrims over 50 years of age increases, this significantly increases the duration of the rituals.

3.6.2.4. Simultaneous change of Tawaf and Sayee scenarios

Other scenarios were developed by simultaneously changing the percentages of pilgrim group at selected combinations of Tawaf and Sayee areas, but not at the gates. The changes were made sequentially, allocating from 0% to 80%, in steps of 10%. Table 3-9 shows the average time of Tawaf and Sayee rituals in the selected areas, as well as the total number of pilgrim groups completing the rituals in 30 hours. The poorest results, unsurprisingly, occur when multiple areas are closed or when the utilisation of the infrastructure/resources is unbalanced, primarily over-utilisation of the GL Tawaf and L1 and L2 Sayee areas. In contrast, judicious allocation of groups to the areas, proportionate to their capacities, leads to a satisfactory completion of the rituals within the planned time, while ensuring good LoS (less than 4 pilgrims/m²). Closing the roof area of Tawaf and levels 2 and 3 Sayee has little impact on the number of pilgrims completing the rituals, but will increase crowding and LoS may exceed 4-5 pilgrims/m² in the adjacent areas. The results also highlight that Sayee ritual is generally longer than the Tawaf, reflecting the distance pilgrims require to cover between the two hills.

3.6.2.5. Allocation of gates to pilgrim groups

Guided results of the mixed scenarios (Section 3.4) and by previous scholarly work, we examined scenarios in which pilgrim groups were assigned to a specific entry gate, depending on their bus stop locations around the Grand Mosque: SA to King Abdulaziz gate (K.Az.); Locals to King Fahad gate (K.F.); Arabs to Al-Umrah gate (U); SEA and Iran to Al-Fatah gate (F); Africa and Arabic Gulf to Al-Marwah gate (M) and TEAA to King Abdullah gate (K.A.) (see Figure 3-7¹³). All pilgrim groups completed the rituals in 1,550 minutes, significantly less (138 minutes) from the original model where pilgrim groups enter randomly (1,688 min). Together with scheduling, this managerial strategy could lead to big improvements in completion times.

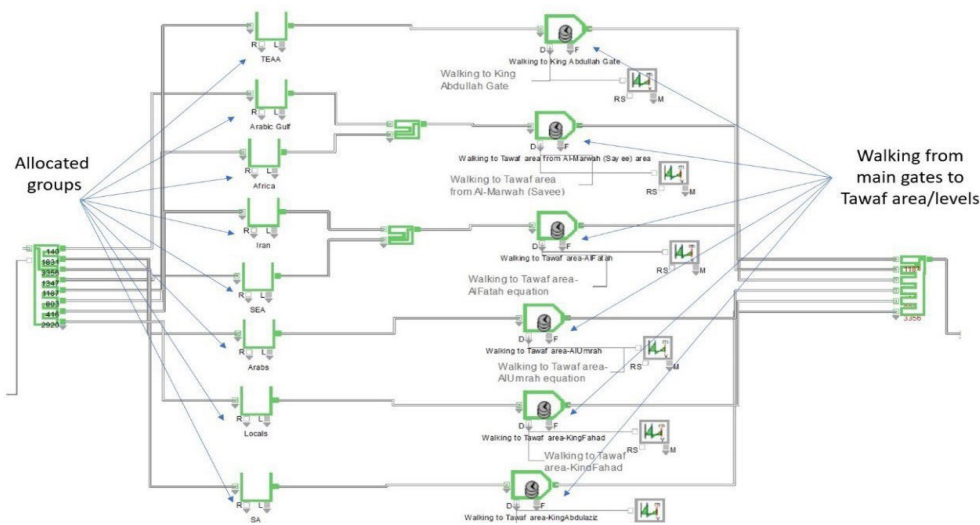

Figure 3-7: Allocated groups

3.6.2.6. Evacuation scenarios

Cuesta et al. (2016) mentioned three possible approaches when developing new scenarios for evacuation models: use of legacy models, improving current models or developing new evacuation models. Our approach was using legacy models, testing evacuation scenarios developed previously, then compare the results of these

¹³ <https://cloudstor.aarnet.edu.au/plus/s/yroSa2ykQRaVkmz>

previous studies to ours, considering the differences in the infrastructure of evacuation scenarios. In addition, the evacuation scenarios can be categorised depending on how human movement is incorporated, either as flow-based, CA, ABM and activity-based model; or by considering the level of aggregation (macro-, micro-, and effect based) (Cuesta et al., 2016). Our research approach fits the activity-based, macro-level description, offering insights on the managerial solutions potentially applicable to Hajj.

A few evacuation scenarios were developed to analyse how long it takes for the pilgrim groups to be evacuated from the four main areas of the GM (Tawaf, Sayee, transition between Tawaf-Sayee areas and the main exits), during their rituals. Additional blocks were added to the simulation model to depict pilgrim movement to the nearest gates instead of continuing their progression through the rituals. The new evacuation (Activity blocks) in each area were associated with Equation blocks specifying the walking times to the existing gates.

As indicated in Section 3.5.1, six big entry gates are connected to the Tawaf area and used as exits after the Sayee. However, in the evacuation model, all 179 gates were dynamically allocated to various pilgrim groups depending on the numbers and locations of the pilgrims at the time of evacuation.

Figure 3-8¹⁴ shows the total number of groups of pilgrims within the main areas of Tawaf, Sayee, in transit between Tawaf-Sayee, their totals, and the cumulative number of groups that had exited the GM, over time. The chart is also indicative of the time at which pilgrims perform Tawaf and Sayee, and when they reach the highest numbers, based on the arrivals. As expected, the highest number of pilgrims in Tawaf seems to be recorded around 12 hours after the official time of the start of the ritual, and after 14 hours for Sayee. This is the critical time for evacuation and likely to lead to longest evacuation times, given that more than a quarter of the pilgrims are in the Tawaf-Sayee areas performing their rituals. At this time, less than 2,000 groups were yet to commence their rituals. In an evacuation situation, they will not be entering the GM but will need to disperse, to allow the pilgrims inside the GM to exit.

¹⁴ <https://cloudstor.aarnet.edu.au/plus/s/hnqoazhDQg7dq2e>

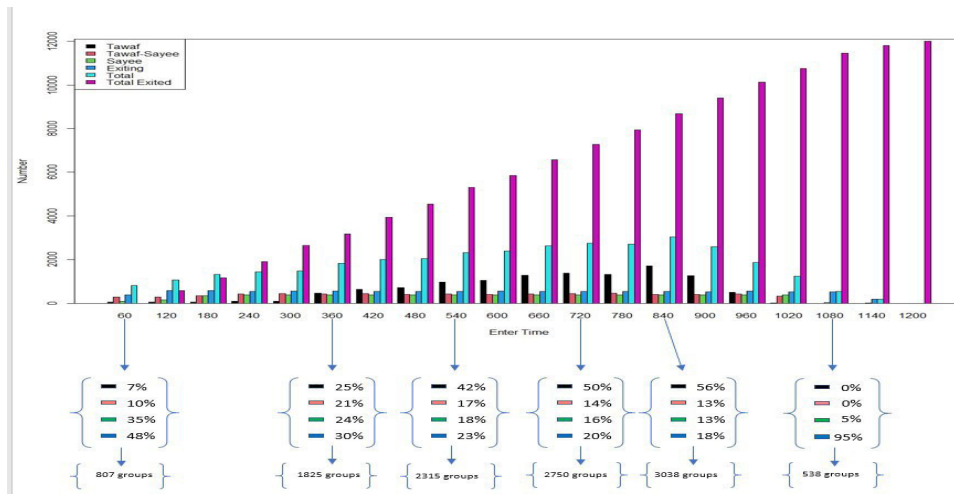

Figure 3-8: Total number of groups of pilgrims at areas of Tawaf, Sayee, in transit between Tawaf-Sayee and the cumulative number of groups that had exited the GM, over time.

The chart is complemented by details of the split of the number of groups of pilgrims in each area during the evacuation at 60, 360, 540, 720, 840 and 1,080 minutes. After 60 minutes, 7% of the pilgrims are in Tawaf, while most groups are performing Sayee and exiting. After six hours (360 minutes) since the start of the simulation, pilgrim groups are spread evenly across all GM areas. After nine hours (540 minutes), Tawaf area recorded the largest proportion of groups of pilgrims within the GM. This continues to increase steadily, so that after 12-16 hours (720-840 minutes), 50% to 56% of the groups are performing Tawaf. After this time, most pilgrims within the GM are expected to complete Sayee, before all the pilgrims finish their rituals and exit the system. The simulation was run for 20 hours, with 95% of the groups exiting the system within 18 hours (1,080 minutes).

3.7. Discussion of Results

The results of the one-way sensitivity analysis (Table 3-8) show that all pilgrim groups completed the rituals except when the Tawaf area is underutilised (<30%) or closed. When the main Tawaf area, preferred by the pilgrims, was closed, only 9,000 groups out of 12,000 groups could be accommodated. In the scenario with equal percentages at all Tawaf levels (except for the handicap mobility area at level 1), only 10,836 groups completed the rituals in the allotted time. Queues, building up at all Tawaf levels, required more time for

finishing the ritual. When the Tawaf area accommodates 30-50% of pilgrims, all pilgrims could complete the rituals in 30 hours, with some queues built at the Tawaf area and Sayee GL (the most critical Sayee area). Closure of other areas (gates, Sayee GL or L3) did not impact the completion of the rituals within 30 hours. Our results also show that when the Tawaf area and the Sayee GL receive up to 60% of the pilgrims (LoS = 5 p/m²) there are no queues in the system. Therefore, these scenarios could potentially offer managerial methods in organising pilgrim movements inside the Grand Mosque. If the LoS needs to be maintained at less than 1p/m², an anticipated requirement for physical distancing related to COVID-19, the number of pilgrims performing Hajj has to diminish accordingly. The entry gates have a direct impact on crowd build-up on Tawaf and Sayee levels. Some queues are generated at the Tawaf and Sayee GL, due to the changes in the entry percentages in the entry allocation scenarios. Increasing allocations to King Abdulaziz, Al-Marwah and King Abdullah gates decreases the waiting times, whereas the closure of any of these increases the waiting times. Given the follow-on effects of gate allocation on the upstream and downstream activities, gate allocation should be given priority in the planning of Hajj rituals in the Grand Mosque.

Table 3-8: Allocations for the Tawaf and Sayee Scenarios

Entry/Exit Gates (%)						Tawaf levels (%)					Sayee levels (%)					Completion (#Groups out of 12,000)	
K. A.	M	F	U	K. F.	K.Az	Tawaf Area	GL	L1	L1 (MR*)	Roof L	BL	GL	L1	L1 (MR*)	L 2	L3	
Entry gates allocations																	
10	10	20	30	30	0	No changes from 2019 in Tawaf, Sayee allocations and exit gates											12,000
			20	30	10												
				20	20												
16	16	17	17	17	17												
0	10	15	15	30	30												
Tawaf level allocations																	
No changes from 2019 allocations to entry and exit gates						0	35	35	1	29	No changes from 2019 allocations to Sayee levels					9,151	
						30	24	25		20							
						40	20	20		19						12,000	
						50	15	15		9							
						60	15	15		24							
						25	25	25								10,836	
Sayee level allocations																	
No changes from 2019 allocations in gates allocations for entry, exit and Tawaf levels											20	0	30	1	29	20	12,000
												30			15	14	
												40	20		10	9	
												50			5	4	
												20			20	19	
												15.5	57.5		22	4	

Exit gates allocations								
Entry/Exit Gates (%)				Tawaf levels (%)		Sayee levels (%)		Completion (#Groups out of 12,000)
20	0	30	30	10	10	No changes from real data 2019 in Tawaf, Sayee allocations and entry gates	12,000	
	10	25	25					
	20	20	20					
10	30	15	15	15				
16	16	17	17	17	17			
0	30	30	20	10	10			

 Gate or level is closed. K.A. = King Abdullah, M = Al Marwah, F = Al-Fatah, U=Al-Umrah, K.F. = King Fahad, K.Az = King Abdul Az

The simulation results in the Mixed Scenarios [section 3.6.2.3], indicate that the allocation of pilgrims to areas proportional to their capacity is essential. Pilgrim percentages between 30% to 80% at Tawaf area and Sayee GL lead to better results and all groups completed the rituals. However, when the percentage allocations were increased to 60%, 70% and 80% at the remainder of Tawaf and Sayee levels, crowds built up and fewer pilgrims completed the rituals. On average, Tawaf lasts between 30 and 55 minutes, depending on the distribution of pilgrims by areas, and the Sayee ritual lasts between 40 and 60 minutes. In addition, closing one or two entry gates (while keeping all exit gates open) leads to fewer pilgrim groups (between 5,000 to 9,000 groups) completing the rituals. Therefore, closing entry gates is not an efficient managerial strategy in organising pilgrims when entering the GM or evacuating it.

Maintaining the gate allocation but changing the distribution in the Tawaf and Sayee areas (Table 3-9), gave similar results, confirming that underutilisation of the Tawaf or Sayee GL (< 10% of pilgrim groups) has a negative effect on completing the rituals (only 9,000 to 10,000 groups). However, when the utilisation is 20%, all pilgrims complete the activities. In the scenario 30% in Tawaf area and Sayee GL, more than 9,000 pilgrims (75%) completed the rituals, because the Tawaf Roof level and Sayee L2 were closed. Delays were recorded for the remaining 25% of the pilgrims crowding at these areas. The scenarios of 40%, 60%, 70% and 80% (No. 5, 7, 8 and 9) simulate all pilgrims efficiently, even though in the 80% scenario two levels were closed on both Tawaf and Sayee areas. The closures of these levels indicate that whenever the critical areas of Tawaf area and Sayee GL receive up to 80% (LoS = 6 p/m²), the rituals can be performed without many disruptions. Finally, in the 50% scenario, about 10,000 groups completed the rituals. The main reason is the delay due to closures of Tawaf L1 and roof levels and Sayee levels L1 and L2, which occurred again in the scenario with 80% in the Tawaf and Sayee GL. However, when these closures were associated with the 80% use of the Tawaf and Sayee GL, all groups were simulated within 30 hours.

Tawaf GL and Sayee BL are the next critical areas (scenarios no.10-18 in Table 3-9). In the scenarios of 0%, 10% and 20%, 5,000 to 8,000 groups of pilgrims (41-66%) complete the rituals. The delays appear from the crowds built on the Roof level and Sayee L2. However, in the 30% and 40% scenarios, all pilgrims complete the rituals, even though Tawaf L1 and Sayee L1 were closed. When the percentages in the Tawaf GL and Sayee BL increase over 50%, less than 9,500 pilgrim groups are simulated. Crowds are built at the same areas because the largest areas in Tawaf and Sayee received only 10% up to 30% of the total number of pilgrim groups.

Scenarios 19 to 27 (from Table 3-9) considered percentages from 0% to 80% in the Tawaf L1 and Sayee L1. Again, because the main Tawaf area and GL, as well as Sayee BL and GL were closed, only 5,326 to 7,104 groups completed the activities. These closures additionally lead to crowd building in these areas, especially when pilgrims' percentages were from 60% to 80%. On the other hand, when Tawaf L1 and Sayee L1 only received 20% of the pilgrims, this enabled all pilgrims to complete the rituals.

Table 3-9: Simultaneous Tawaf and Sayee scenarios and results

Scenario No.	Tawaf levels (%)						Sayee levels (%)							LoSin Tawaf area (pilgrims/m ²)	LoSin Sayee GL area (pilgrims/m ²)	Duration of Tawaf (mins)	Duration of Sayee (mins)	Completion (# Groups out of 12,000)
	Tawaf Area	GL	L1	L1 (MR)	RoofL	BL	GL	L1	L1 (MR)	L2	L3	LoSin Tawaf GL (pilgrims/m ²)	LoSin Sayee BL (pilgrims/m ²)					
1	0	50	30	5	15	50	0	30	5	7	8	0	0	N/A	N/A	9,692		
2	10	40	40	5	5	40	10	20	5	20	5	0.77	0.72	N/A	N/A	10,340		
3	20	30	30	5	15	30	20	20	5	15	10	1.54	1.44	N/A	N/A	12,000		
4	30	20	45	5	0	20	30	30	5	0	15	2.32	2.16	N/A	N/A	9,495		
5	40	10	30	5	15	10	40	10	5	15	20	3.09	2.87	32.60	49.33	12,000		
6	50	45	0	5	0	40	50	0	5	0	5	3.86	3.59	32.60	49.33	10,700		
7	60	10	15	5	10	10	60	10	5	10	5	4.63	4.31	32.60	49.33	12,000		
8	70	5	10	5	10	5	70	5	5	10	5	5.41	5.03	32.60	49.33	12,000		
9	80	15	0	5	0	18	80	0	5	0	0	6.18	5.75	32.60	49.33	12,000		
Tawaf levels																		
10	36	0	10	4	50	0	36	30	4	20	10	0	0	N/A	N/A	5,255		
11	25	10	21	4	40	10	20	21	4	40	5	1.06	0.72	N/A	N/A	6,320		
12	15	20	31	4	30	20	15	10	4	30	21	2.12	1.44	N/A	N/A	8,157		
13	35	30	11	4	20	30	35	5	4	20	6	3.18	2.16	N/A	N/A	12,000		
14	50	40	0	4	1	40	50	0	4	6	0	4.25	2.87	30.03	43.41	12,000		
15	40	50	6	4	0	50	40	5	4	0	1	5.31	3.59	30.03	43.41	9,493		
16	30	60	3	4	3	60	30	5	4	0	1	6.37	4.31	30.03	43.41	7,127		
17	20	70	3	4	3	70	20	4	4	0	2	7.43	5.03	30.03	43.41	6,795		
18	10	80	0	4	6	80	10	0	4	6	0	8.49	5.75	30.03	43.41	6,017		
Sayee levels																		

Scenario No.	Tawaf levels						Sayee levels						LoSin Tawaf L1 (pilgrims/m ²)	LoSin Sayee L1 (pilgrims/m ²)	Duration of Tawaf (mins)	Duration of Sayee (mins)	Completion (# Groups out of 12,000)
	Tawaf Area	GL	L1	L1 (MR)	Roof L	BL	GL	L1	L1 (MR)	L2	L3	LoSin Tawaf Roof L (pilgrims/m ²)					
19	35	50	0	3	12	35	50	0	3	10	2	0	0	N/A	N/A	9571	
20	25	40	10	3	22	25	40	10	3	5	17	1.21	0.72	N/A	N/A	9,844	
21	35	30	20	3	12	35	30	20	3	5	7	2.42	1.44	N/A	N/A	12,000	
22	0	20	30	3	47	0	20	30	3	47	0	3.63	2.16	N/A	N/A	5,722	
23	0	10	40	3	47	0	10	40	3	20	27	4.85	2.87	42.90	45.30	5,449	
24	10	0	50	3	37	10	0	50	3	3	7	6.06	3.59	42.90	45.30	7,104	
25	7	0	60	3	30	7	0	60	3	20	10	7.27	4.31	42.90	45.30	7,037	
26	6	1	70	3	20	6	1	70	3	10	10	8.48	5.03	42.90	45.30	6,071	
27	1	6	80	3	10	1	6	80	3	5	5	9.69	5.75	42.90	45.30	5,326	
	Tawaf levels						Sayee levels										
28	50	20	28	2	0	50	15	15	2	0	18	0	0	N/A	N/A	12,000	
29	40	30	18	2	10	40	30	10	2	10	8	1.21	0.72	N/A	N/A	12,000	
30	30	20	28	2	20	30	20	20	2	20	8	2.42	1.44	N/A	N/A	12,000	
31	20	30	18	2	30	20	30	15	2	30	3	3.63	2.16	N/A	N/A	12,000	
32	8	50	0	2	40	10	50	0	2	40	8	4.85	2.87	55.25	61.67	8,289	
33	8	40	0	2	50	20	10	0	2	50	18	6.06	3.59	55.25	61.67	6,121	
34	38	0	0	2	60	30	0	0	2	60	8	7.27	4.31	55.25	61.67	4,582	
35	28	0	0	2	70	8	10	5	2	70	5	8.48	5.03	55.25	61.67	4,503	
36	18	0	0	2	80	18	0	0	0.02	80	0	9.69	5.75	55.25	61.67	3,649	

Gate or roof is closed
 Scenario pattern
 Acceptable
 Lost fire
 Lost liturgically service tools

Note: Lost derived only for the roof area in red color. Capacities for Tawaf L1 and Roof level, and all the Sayee levels are the same.

Finally, when the least preferred or accessible Tawaf and Sayee areas, Tawaf Roof level and Sayee L2, are increasingly being used, with the same pattern, accommodating pilgrims between 40 to 80%, queues appear and only 3,649 to 8,289 groups could complete the rituals within 30 hours. The crowded locations were Tawaf L1 and Sayee L1, as well as tested areas. Scenarios of 0 to 30% simulated all pilgrims, as the critical areas (Mataf and Sayee GL) accommodated 30 to 50% of pilgrim groups.

Table 3-10 provides a summary of the main results of the simultaneous Tawaf and Sayee scenarios [section 3.6.2.4] and the number of simulated pilgrims is given in relation to the percentage of pilgrims assigned to the area. The results confirm that allocating more than 30% of pilgrims to Tawaf L1 and Sayee L1, or to Tawaf Roof L and Sayee L2, is unwise, as less than $\frac{3}{4}$ of the pilgrim groups can complete the rituals. The optimal allocation is when using Tawaf and Sayee GL according to their capacities and when distributing 30-40% of the pilgrims to the Tawaf GL and Sayee BL.

In terms of evacuation from the GM (Table 3-11), previous studies presented longer durations than obtained in this research. For example, studies reported 14 minutes from Tawaf GL and 22 minutes from Tawaf Roof level (Halabi, 2006), 47 minutes from Sayee GL (Abdelghany et al., 2010) and 7 minutes from Tawaf area (Mahmood et al., 2017). Our results from Table 3-11 show shorter evacuation durations. We selected a discrete number of times when the evacuation may occur, at 60, 360, 540, 720, 840 and 1,080 minutes during the rituals. The evacuation from the Tawaf area takes between 10.05 to 11.18 min, from GL between 4.69 to 8.64 min, from L1 between 6.53 to 11.81 min, and from the Roof level between 8.89 to 13.90 min, according to the distances to the nearest exit gates. The evacuation durations from Sayee BL are between 4.46 to 9.11 min, from GL between 6.11 to 10.29 min, from L1 between 8.90 to 12.82 min, from L2 between 10.74 to 13.93 min and from L3 between 12.63 to 15.93 min.

To complete the insights on the effects of evacuation at various times during the Hajj rituals, Table 3-12 shows the number of evacuated pilgrims from the Grand Mosque at the given times, from their locations during the evacuation process. The total number of groups at all times is 12,000 groups.

Additionally, all evacuated groups used all the Grand Mosque's exits (179 gates) in the evacuation simulation. Table 3-12 shows that the maximum LoS is about 3.41 pilgrims/m² at Tawaf and 2.56 pilgrims/m² at Sayee. These figures are promising, indicating reduced chance of crowds building in various areas of the Grand Mosque. As Algahdi and Still (2010) suggested, crowd density at max 4

people/m² is a safe limit for crowd flow. Therefore, pilgrims at Tawaf and Sayee are evacuated without any complications. The same observation can be made in relation to the number of groups evacuated from each of the 179 gates (including the gate of King Abdullah’s new building). From Table 3-12, the maximum number of groups evacuated is about 4.55, which is equivalent to approximately 1,137 pilgrims per gate, regardless on the time when the evacuation is occurring.

Table 3-10: Results of simultaneous Tawaf and Sayee scenarios

Tawaf and Sayee levels	Pilgrim Percentages (%)								
	0	10	20	30	40	50	60	70	80
Tawaf area and Sayee GL	9692	10340	12000	9495	12000	10700	12000	12000	12000
Tawaf GL and Sayee BL	5255	6320	8157	12000	12000	9493	7127	6795	6017
Tawaf L1 and Sayee L1	9571	9844	12000	5722	5449	7104	7037	6071	5326
Tawaf Roof L and Sayee L2	12000	12000	12000	8289	6121	4582	4503	3649	3330

■ Acceptable results (LoS)
■ Fair results (LoS)
■ Unacceptable service level (queuing time)

Table 3-11: Comparison of evacuation results with previous studies

Study	Duration of evacuation from Tawaf levels (min)				Duration of evacuation from Sayee levels (min)				
	Tawaf area	GL	L1	Roof L	BL	GL	L1	L2	L3
Halabi (2006) (Please see to Table 3-1, where different number of pilgrims are simulated [44,210; 277,938 pilgrims])	2.15	13.73	7.98	22.36	N/A				
Abdelghany et al. (2010) (Please see to Table 3-2, where different number of pilgrims are simulated [5,000; 25,000 pilgrims])	N/A				N/A	1 st set 9.97 32.10 47.08	N/A		
						2 nd set 20.62 19.32 18.88			
						5 th set 16.6 18.6 16.1 21.0			
Mahmood et al. (2017) [10,000 pilgrims]	7.4 4.0 3.1	N/A			N/A				
This study (3 million pilgrims)									
60 min	10.05	4.69	6.53	8.98	6.31	7.21	9.08	11.69	14.51
360 min	10.81	8.64	11.81	13.90	4.55	6.11	8.90	10.74	12.74
540 min	10.52	5.83	7.64	9.57	4.46	7.08	10.16	11.59	12.63
720 min	11.29	5.70	7.00	8.89	9.11	10.29	12.82	13.93	15.93
840 min	11.18	6.16	8.40	11.40	8.40	10.06	12.22	13.02	14.22
1080 min	N/A	N/A	N/A	N/A	6.70	8.87	9.95	10.86	13.15

Table 3-12: Number of evacuated groups in the evacuation model

Evacuation time	No. of groups NOT entered the simulation	No. of evacuated groups				No. of groups finished and exited the simulation	Total groups No.	Total evacuation exits	LoS		Avg. No. of groups per gates
		Tawaf area and levels	Tawaf-Sayee area	Sayee levels	Exits				Tawaf	Sayee	
60 min	11,400	44	224	66	266	0	12,000	179	3.31	2.56	3.35
360 min	8,400	46	228	54	487	2,785			3.40	2.41	4.55
540 min	6,600	43	221	61	472	4,603			3.26	2.46	4.45
720 min	4,800	47	226	56	490	6,381			3.40	2.43	4.57
840 min	3,600	49	223	56	473	7,599			3.41	2.41	4.47
1,080 min	1,200	0	0	65	463	10,272			N/A	0.93	2.94

Note: Number of evacuated groups from Tawaf-Sayee (transit) area were split between Tawaf and Sayee levels for the calculation of LoS at Tawaf, Sayee and the Avg. number of groups exited from each gate.

3.8. Conclusion and future work

Hajj is the largest mass gathering event in the world. Mitigation of overcrowding at Hajj sites is one of the daunting tasks faced by Hajj officials. Prior planning to organise the movements of the pilgrims, especially for the Tawaf and Sayee rituals, is not only recommended for better use of resources, but also to avoid deleterious effects of emergency situations. While previous studies presented different approaches of Tawaf or Sayee management separately, an important contribution of this work is an integrated Tawaf and Sayee model with various scenarios, using the DES tool “ExtendSim” as a research method. Various scenarios were developed to offer different managerial options. The scenarios considered different aspects in pilgrim management at entrances and exits of the Grand Mosque, and Tawaf and Sayee rituals.

Without a micro-level description of physical structures and of individual entities or pilgrims, this study offers insights into the optimal allocations of pilgrims to control crowd density in the GM, in the most strained areas in terms of capacity, and on the conditions of evacuation (LoS, flow capacities, times to traverse or cross the GM towards exit gates). In addition, it shows that by scheduling the two rituals and an adequate allocation to the various levels of the Grand Mosque, there is potential for accommodating larger numbers of pilgrims within the same time window of 30 hours. For example, the average duration required for a number of four million pilgrims to complete both Tawaf and Sayee is 1,783 min (assuming current conditions and no critical incidents), which suggests reserves of capacity could be created through planning. Although our target was to simulate 3 million pilgrims, using the same conditions, the model could simulate up to 4 million pilgrims within the allotted 30 hours.

After validating the simulation model with the 2019 Hajj data, more than 200 distinct scenarios, manipulating a single factor or multiple factors, were examined.

The results show that distributing pilgrim groups according to the capacity achieves superior LoS, whereas closing entry gates, exit gates, and some Tawaf and Sayee levels will negatively affect LoS. The magnitude of these impacts depends on the allocation. Allocating more than 30% of the pilgrim groups to the upper levels of Tawaf and Sayee would result in queues and an LoS above 4 pilgrims/m². Another factor to consider is the age distribution of pilgrims, which affects the duration of rituals and movements between sites. On average, the Tawaf ritual lasts up to 55 min, whereas the Sayee up to 62 min, reflecting the distances pilgrims' traverse during rituals.

The simulation results confirm that the most critically high crowd density areas (yet preferred by pilgrims) are the Tawaf area (Mataf) and Sayee Ground Level (GL). As indicated, when these areas accommodated 30% to 80% of pilgrims, all pilgrims completed the rituals in a timely fashion. On the contrary, when other Tawaf and Sayee areas were assigned high percentages of pilgrims, the scenarios showed delays and inability to accommodate all pilgrim groups to complete the rituals within 30 hours. Therefore, it is recommended to distribute the pilgrims gradually, starting from the Tawaf and Sayee critical areas (Tawaf area and Sayee GL) followed by other levels. Another managerial method that could be considered in the organisation of the event is the allocation of each pilgrim group to a certain gate for entry and exit.

These findings create the prospect of more realistic strategies, which can be then further analysed at an individual pilgrim level. Currently, modelling the potential of panic, crowding behaviour (body movements, reactions) is impeded by treating pilgrims in groups with relatively homogeneous features and without considering emergent behaviour of pilgrims. However, the model presented here is part of a series of DES modelling the whole Hajj. Depending on the timing and location of emergency evacuation, procedures and consequences differ. In addition to identifying areas and pathways for evacuation response, the model showed that awareness of the exits and evacuation paths and training, as well as scheduling considering the physical agility of pilgrims, are critical factors that could ensure completing the evacuation in minimum times.

Consistent with Halabi (2006) who alerted to the long duration of the processes, our results showed shorter evacuation times compared with other state of the art methods. Yet, this may be due to our meso-level treatment of the crowd and the ‘locally optimised’ decisions, considering natural flows from one part of the Grand Mosque to another, avoiding intersections of pedestrian routes. It is also recommended to apply better schedule planning regarding arriving and departing the Grand Mosque. For example, pilgrims who are well and fit (see Table 3-14) and can finish the rituals quickly, can be scheduled to arrive earlier, at the beginning of the Tawaf Al-ifadah day. Conversely, pilgrims less fit and who would require longer time in their ritual performance, can be scheduled to arrive later. This can be used as a managerial method in prior planning to organise the movements of the pilgrims, avoiding various pilgrim groups crossing each other and causing delays.

Unlike Abdelghany et al. (2010) who explored the possibility that entities can decide which exit to choose during evacuation, in our model, we made the decision that groups are allocated evacuation exits depending on three factors: the nearest gates; further gates but within the same area; and using any available gates. However, we concur with Abdelghany et al. (2010) that training pilgrims how to react in emergency situations is of paramount importance. This could be done either by receiving training before arrival or at least by training the group leaders, who have experience in performing Hajj rituals and are familiar with the facilities. Future work could develop normal and evacuation scenarios to test the organisation of the pilgrims during other Hajj rituals, at different locations.

Acknowledgements

The main author of this study is funded and sponsored by the Saudi Arabian Cultural Mission (SACM) in Canberra, Australia, the educational representative of the Royal Embassy of the Kingdom of Saudi Arabia. In addition, the authors are thankful to the Ministry of Hajj for providing the data of this research. The authors would also want to thank Kathi Hansen, the academic representative of Imagine That Inc., for granting access to ExtendSim software for this research.

References

1. Al-Tawfiq, J.A., Gautret, P., Benkouiten, S., & Memish, Z.A. (2016). Mass gatherings and the spread of respiratory infections. Lessons from the Hajj. *Annals of the American Thoracic Society*, 13(6), 759-765.
2. Memish, Z.A., Stephens, G.M., Steffen, R., & Ahmed, Q.A. (2012). Emergence of medicine for mass gatherings: lessons from the Hajj. *The Lancet Infectious Diseases*, 12(1), 56-65.
3. Mahmood, I., Haris, M., & Sarjoughian, H. (2017). Analyzing emergency evacuation strategies for mass gatherings using crowd simulation and analysis framework: Hajj scenario. In *Proceedings of the 2017 ACM SIGSIM Conference on Principles of Advanced Discrete Simulation* (pp. 231-240).
4. Yamin, M., & Albugami, M.A. (2014). An architecture for improving Hajj management. In *International Conference on Informatics and Semiotics in Organisations* (pp. 187-196). Springer, Berlin, Heidelberg.
5. Tunasar, C. (2013, December). Analytics driven master planning for mecca: Increasing the capacity while maintaining the spiritual context of hajj pilgrimage. In *2013 Winter Simulations Conference (WSC)* (pp. 241-251)
6. Osman, M., & Shaout, A. (2014). Hajj Guide Systems-Past, Present and Future. *International Journal of Emerging Technology and Advanced Engineering*, 4(8), 25-31.
7. Basalamah, A. (2016). Sensing the crowds using bluetooth low energy tags. *IEEE access*, 4, 4225-4233.
8. Khwaja, A.A. (2017). A Real-time DBMS System for the Immigration Processing of Large Hajj Crowd. *International Journal of Modern Education and Computer Science*, 9(9), 32-41.
9. Felemban, E. A., Rehman, F. U., Biabani, S. A. A., Ahmad, A., Naseer, A., Majid, A. Hussain, O., Qamar, A., Felemban, R., & Zanjir, F. (2020). Digital Revolution for Hajj Crowd Management: A Technology Survey. *IEEE Access*, 8, 208583-208609.
10. Rahman, A., Hassanain, E., & Hossain, M. S. (2017). Towards a secure mobile edge computing framework for Hajj. *IEEE Access*, 5, 11768-11781.
11. Fourati, J., Issaoui, B., & Zidi, K. (2017). Literature Review of Crowd Management: A Hajj Case Study. In *ICINCO (1)* (pp. 346-351).
12. Ahmed, Q. A., & Memish, Z. A. (2020). The cancellation of mass gatherings (MGs)? Decision making in the time of COVID-19. *Travel Medicine and Infectious Disease*, 101631.
13. Haghghati, R. & Hassan, A. (2013). Modeling the flow of crowd during tawaf at Masjid Al-Haram. *Journal Mekanikal*, 36(1).
14. Alluhaidan, A. & Alredhaiman, A. (2016). Location Analysis of Mina Site: One of the Most Crowded Areas at Hajj. In *Proceedings of the Conference on Information Systems Applied Research ISSN* (Vol. 2167, p.1508).
15. Al-Kodmany, K. (2013). Crowd management and urban design: New scientific approaches. *Urban Design International*, 18(4), 282-295.
16. Haase, K., Al Abideen, H. Z., Al-Bosta, S., Kasper, M., Koch, M., Müller, S., & Helbing, D. (2016). Improving pilgrim safety during the hajj: an analytical and operational research approach. *Interfaces*, 46(1), 74-90.
17. Al-Nabulsi, H., & Drury, J. (2014). Social identification moderates the effect of crowd density on safety at the Hajj. *Proceedings of the National Academy of Sciences*, 111(25), 9091-9096.
18. Alabdulkarim, L., Alrajhi, W., & Aloboud, E. (2016, July). Urban Analytics in Crowd Management in the Context of Hajj. In *International Conference on Social Computing and Social Media* (pp. 249-257). Springer, Cham.
19. Owaidah, A., Oлару, D., Bennamoun, M., Sohel, F., & Khan, N. (2019). Review of modelling and simulating crowds at mass gathering events: Hajj as a case study. *Journal of Artificial Societies and Social Simulation*, 22(2), 1-9.
20. Mlybari, E., Ahmed, I. and Khalil, M. (2016). Disaster Risk Management In KSA: Current State of Practice, Research Gate, https://www.researchgate.net/profile/Hasan_Khalil/publication/303383344_CURRENT_STATE_OF_PRACTICE_IN_DISASTER_RISK_MANAGEMENT/links/5910a9f3a6fdccbf585b2cf/CURRENT-STATE-OF-PRACTICE-IN-DISASTER-RISK-MANAGEMENT.pdf, accessed on 09/04/2018.
21. Alaska, Y. A., Aldawas, A. D., Algerian, N. A., Memish, Z. A., & Suner, S. (2017). The impact of crowd control measures on the occurrence of stampedes during Mass Gatherings: The Hajj experience. *Travel Medicine and Infectious Diseases*, 15, 67-70.
22. Shalaby, A.S. Kaysi, I. Al-Zahrani, A.H. Al-Shalalfah, B.W. & Sayegh, A. (2013). Towards a Sustainable Transport System for the Holy City of Makkah: Coping with Harsh Topography, Dense Urban Area and Large-Scale Religious Events. *17th International Road Federation (IRF) World Meeting and Exhibition 2013, 10-14 November 2013*. Riyadh, Saudi Arabia.

23. Bahurmoz, A. M. (2006). A strategic model for safety during the Hajj pilgrimage: An ANP application. *Journal of Systems Science and Systems Engineering*, 15(2), 201-216.
24. Ochoa, A., Rudomin, I., Vargas-Solar, G., Espinosa-Oviedo, J.A., Pérez, H., & Zechinelli-Martini, J.L. (2017). Humanitarian logistics and cultural diversity within crowd simulation. *Computacion y Sistemas*, 21(1), 7-21.
25. Abdelghany, A., Abdelghany, K., & Mahmassani, H. (2016). A hybrid simulation-assignment modeling framework for crowd dynamics in large-scale pedestrian facilities. *Transportation Research Part A: Policy and Practice*, 86, 159-176.
26. Nasir, F. M., & Sunar, M. S. (2016, November). Simulating large group behaviour in tawaf crowd. In *2016 Asia Pacific Conference on Multimedia and Broadcasting (APMediaCast)* (pp. 42-46). IEEE.
27. Felemban, E., Al-Qahtani, K., Hawsawi, A. & Al-Shihri, A. (2018). Building a simulation model of crowd movement around the Holy Kaaba. *Scientific forums for Hajj, Umrah and Visitation Research, Custodian of the Two Holy Mosques Institute for Hajj and Umrah Research*, 17(7), pp. 727-737.
<http://hajjresearchrep.com/handle/123456789/274?locale-attribute=en>
28. Löhner, R., Haug, E., & Britto, M. (2018). Social Force Modeling of the Pedestrian Motion in the Mataf. In *Proceedings from the 9th International Conference on Pedestrian and Evacuation Dynamics (PED2018) Lund, Sweden – August 21-23, 2018*, pp. 528-530.
29. Mohamed, S. A. E., & Parvez, M. T. (2019). Crowd Modelling Based Auto Activated Barriers for Management of Pilgrims in Tawaf. In *2019 International Conference on Innovative Trends in Computer Engineering (ITCE)* (pp. 260-265). IEEE.
30. Kolivand, H., Rahim, M. S., Sunar, M. S., Fata, A. Z. A., & Wren, C. (2020). An integration of enhanced social force and crowd control models for high-density crowd simulation. *Neural Computing and Applications*, 1-23.
31. Sarmady, S., Haron, F., & Talib, A. Z. H. (2008, May). Multi-agent simulation of circular pedestrian movements using cellular automata. In *2008 Second Asia International Conference on Modelling & Simulation (AMS)* (pp. 654-659). IEEE.
32. Mohammad, S., Sunar, M. S., & Hanifa, R. M. (2014). A Review on Tawaf Crowd Simulation: State-of-the-Art. *International Journal of Interactive Digital Media*, 2(11), 1-6.
33. Namoun, A., Mir, A., Alkhodre, A.B., Tufail, A., Alrehaili, A., Farquad, M., Alwaqadani, I., Alghamdi, T. & Benaida, M. (2018). A multi-agent architecture for evacuating pilgrims in panic and emergency situations: The Hajj scenario. *Journal of Theoretical and Applied Information Technology*, 96(20), 6665-6676.
34. Abdelghany, A., Abdelghany, K., Mahmassani, H., Al-Ahmadi, H., & Alhalabi, W. (2010). Modelling the evacuation of large-scale crowded pedestrian facilities. *Transportation Research record*, 2198(1), 152-160.
35. Sakour, I., & Hu, H. (2017). Robot-assisted crowd evacuation under emergency situations: A survey. *Robotics*, 6(2), 8.
36. Halabi, W. S. (2006). Overcrowding and the Holy Mosque, Makkah, Saudi Arabia. Doctoral dissertation, *Newcastle University*.
37. Krahl, D. (2012). ExtendSim: a history of innovation. In *Proceedings of the Winter Simulation Conference* (pp. 1-8).
38. Aurelius, G., & Ingvarsson, M. (2019). Simulation of Production Flow: A simulation-based approach to evaluate and optimize future production scenarios. Master of Science Project in Technology, *Royal Institute of Technology, KTH, in Stockholm, Sweden*.
39. Papageorgiou, G., Damianou, P., Pitsillides, A., Aphantis, T., Charalambous, D., & Ioannou, P. (2009). Modelling and simulation of transportation systems: A scenario planning approach. *Automatika*, 50(1-2), 39-50.
40. Krahl, D. & Nastasi, A. (2014). Reliability Modeling with ExtendSim, In *Proceedings of the 2014 Winter Simulation Conference* (pp. 4219-4225). IEEE.
41. Birgisson, K. (2009). Discrete-Event Simulations of Construction Related Production System, *Lund University, Sweden*.
42. Felemban, E., & Basalamah, S. (2011). User Requirements for Localization and Positioning During Hajj. In *2011 International Conference on Indoor Positioning and Indoor Navigation (IPIN, 21-23 September 2011)*, Guimarães, Portugal.
43. Al-Nabulsi, H. (2015). The crowd psychology of the Hajj, Doctoral dissertation, *University of Sussex*.
44. Kurdi, O., Stannett, M., & Romano, D.M. (2015). Modelling and simulation of Tawaf and Sa'yee: A survey of recent work in the field. In *29th Annual European Simulation and Modelling Conference 2015, ESM 2015* (pp. 441-447). Eurosis.
45. Daye, A. (2018). Grand Mosque Expansion Highlights Growth of Saudi Arabian Tourism Industry, <https://blog.realestate.cornell.edu/2018/03/21/grandmosqueexpansion/>, accessed on 09/04/2018.

46. Al-Salami, F. (2020). 1444 End of the expansion of the Grand Mosque, <https://translate.google.com/translate?hl=&sl=ar&tl=en&u=https%3A%2F%2Fmakkahnews.com%2Farticle%2F1117610%2F>, accessed on 07/04/2020.
47. Shuaibu, A. N., Faye, I., Malik, A. S., & Simsim, M. T. (2015). Simulation of Crowd Movement in Spiral Pattern during Tawaf. *Modern Applied Science*, 9(11), 192-202.
48. Algadhi, S. & Still, G. K. (2010). Designing for crowd safety at Jamarat and Tawaf, http://fac.ksu.edu.sa/sites/default/files/45_designing_for_crowd_safety_at_jamarat_and_Tawaf.pdf, accessed on 29/03/2020.
49. Al-Zahrani, M., (2018). Crowd control methods at the Grand Mosque. Scientific forums for Hajj, Umrah and Visitation Research, *Custodian of the Two Holy Mosques Institute for Hajj and Umrah Research*, 18(6), 367-377. <http://hajjresearchrep.com/handle/123456789/187?show=full>, accessed on 07/04/2020.
50. Sridhar, S., Benkouiten, S., Belhouchat, K., Drali, T., Memish, Z. A., Parola, P., Brouqui, P. & Gautret, P. (2015). Foot ailments during Hajj: A short report. *Journal of Epidemiology and Global Health*, 5(3), 291-294.
51. Zainuddin, Z., Thinakaran, K., & Abu-Sulyman, I. M. (2009). Simulating the circumambulation of the ka'aba using simwalk. *European Journal of Scientific Research*, 38(3), 454-464.
52. Qurashi, J. (2018). Hajj: the movement and behaviour of crowds. In Korstanje, M., Raj, R., & Griffin, K. (Eds.). In *Risk and safety challenges for religious tourism and events*. (pp.52 - 62). CAB International.
53. Khan, I. (2012). Hajj Crowd Management: Discovering Superior Performance with Agent-Based Modelling and Queueing Theory. PhD Thesis, *University of Manitoba*.
54. The General Presidency of The Affairs of the Grand Mosque and The Prophet's Mosque, (2020), the Grand Mosque map, <https://explorer.gph.gov.sa/?lng=en>, accessed on 01/04/2020.
55. Hajj-Umrah-Planner (2019). <https://hajjumrahplanner.com/physical-fitness/>, accessed on 14/07/2019.
56. Sakellariou, I., Kurdi, O., Gheorghe, M., Romano, D., Kefalas, P., Ipate, F., & Niculescu, I. (2014). Crowd formal modelling and simulation: The Sa'yee ritual. In *2014 14th UK Workshop on Computational Intelligence (UKCI)* (pp. 1-8). IEEE.
57. Laguna, M., & Marklund, J. (2013). Business process modelling, simulation and design. *CRC Press*.
58. Bianchi, R.R. (2017). Reimagining the Hajj. *Social Sciences*, 6(2), 36.
59. The General Presidency of The Affairs of the Grand Mosque and The Prophet's Mosque, (2020). Al-Maqsad (Version 1.2), <https://apps.apple.com/au/app/al-maqsad/id1447123573>, accessed on 15/01/2020.
60. The General Presidency of The Affairs of the Grand Mosque and The Prophet's Mosque, (2019). Tawaf distribution, <https://twitter.com/ReasahAlharmain/status/1161593379785969664>, accessed on 14/08/2019.
61. Alshammari, S. M., & Mikler, A. R. (2015). Modelling Disease Spread at Global Mass Gatherings: Hajj as a Case Study. In *2015 International Conference on Healthcare Informatics* (pp. 574-577). IEEE.
62. The General Presidency of The Affairs of the Grand Mosque and The Prophet's Mosque, (2019). Sayee distribution, <https://twitter.com/ReasahAlharmain/status/1161682700463464449>, accessed on 15/08/2019.
63. Okaz (2018). <https://www.okaz.com.sa/local/na/1663004>, accessed on 09/04/2018.
64. Mohamad, S., Sunar, M. S., Hanifa, R. M., & Khader, A. T. (2013). Initial Investigation of Modelling Tawaf Crowd Evacuation Based on Intelligent Agent Simulation. *International conference on Interactive Digital Media*.
65. Cuesta, A., Abreu, O., & Alvear, D. (2016). Future challenges in evacuation modelling. In *Evacuation modeling trends* (pp. 103-129). Springer, Cham.
66. ExtendSim User Reference, (2020). <https://extendsim.com/flipbooks/ExtendSimUserReference.pdf>, accessed on 18/03/2020.
67. Dridi, M. H. (2015). List parameters influencing the pedestrian movement and pedestrian database. *International Journal of Social Science Studies*, 3, 94-106.

Appendix – Block and Input data used in simulation

Table 3-13: ExtendSim Blocks Used in the Models (Laguna and Marklund, 2013; ExtendSim User Reference, 2020).











Block	Function	Block shape/icon
Executive Block	Controls the simulation timing and passing of the systems through the model. This block is placed on the left of all other blocks in the models. The main functions of this block it to schedule the events (system processes), control the simulation, allocate the items, manage the main attributes and other main settings.	
Create Block	Generates items (simulated pilgrims or transport modes) randomly or according to fixed schedules.	
Queue Block	Used as a holding area, where items (pilgrims or transport modes) queue up and wait to be processed. The queue releases the items based on their queuing settings.	
Activity Block	Simulates activity by delaying passing an item through the block in a certain amount of time, equivalent to the processing time of the real system.	
Set Block	Sets the properties of items that pass through the block.	
Get Blocks	Produces item properties from items that are passing through	
Select In Block	Merges the flow of the items from one process (input) to another process (output).	
Select Out Block	Separates the flow of items from one process (output) to another process (input).	
Exit Block	Passes items out of the simulation.	
Plotter Block	Display information on model performance.	

Table 3-14: Pilgrim speeds (m/s) at Hajj event for each Group, Fitness and Age (Dridi, 2015)

Groups	Level of fatigue	Age groups	
		10-50	50+
SEA, SA, Iran, Africa, Araba, Arabic Gulf and Locals	Rested	1.46	1.2095
	Tired	1.3115	1.0885
	Very tired	1.1658	0.9676
TEAA	Rested	1.3247	1.0995
	Tired	1.1923	0.9896
	Very tired	1.0598	0.8796

Table 3-15: Pilgrims incident rates from Hajj events 2002-2015 (Bianchi, 2017)

Category	Total pilgrims	Total deaths	Total death %	Male % (number)	Female % (number)	Average age
Iran	1,173,307	738	0.06%	79.81% (589)	20.19% (149)	66.15
TEAA	1,291,338	935	0.07%	27.09% (674)	27.91% (261)	66.90
SEA	2,770,000	4,386	0.15%	62.35% (2,735)	37.65% (1,651)	63.67
SA (Pakistan)	2,127,112	3,579	0.17%	71.46% (2,558)	28.54% (1,021)	59.16
SA (Bangladesh)	1,032,088	1,783	0.17%	83.86% (1,495)	16.14% (288)	58.32
Africa	1,123,000	1,988	0.18%	53.72% (1,068)	46.28% (920)	54.24
SA (India)	1,480,186	2,803	0.19%	71.89% (2,015)	28.11% (788)	64.40
Arab	1,000,500	2,353	0.23%	66.12% (1,556)	33.88% (797)	59.74

Table 3-16: Distances from the main gates to Ka'aba and starting line (The General Presidency for the Affairs of the Two Holy Mosques, Al-Maqsad app, 2019)

Main Gate	Distance from/to main gate to/from Ka'aba	Distance from/to main gate to/from Starting line	Distances from Sayee to main gates
King Abdulaziz	160m	190m	580m
King Fahad	250m	326m	645m
Al-Umrah	164m	269m	453m
Al-Fatah	164m	330m	200m
Al-Marwah (Sayee area)	350m	516m	100m
King Abdullah	360m	504m	340m

Chapter 4

Chapter 4 : Modelling and Simulating Aljamarat Bridge Rituals³

Abstract

Hajj is the largest mass gathering event globally that occurs annually. It is a pilgrimage that lasts for about a week. The pilgrims perform rituals at different sites (The Grand Mosque, Mina, Arafat and Muzdalifah) in the city of Makkah, Saudi Arabia. Safety of the pilgrims is number 1 priority for the Saudi authorities and several new projects have recently been completed at the Hajj sites with a goal to improve proceedings. One of these projects was the redesign and construction of the Aljamarat Bridge at Mina City. This project was commissioned to mitigate severe crowd incidents at the bridge in previous years. The new bridge has greatly improved safety of pilgrims. However, unexpected hazards and accidents such as fire or gas leaks can occur, necessitating the evacuation of pilgrims from the bridge. This chapter presents a model and simulation study of pilgrim evacuation from Aljamarat bridge using a Discrete Event Simulation (DES) tool called “ExtendSim”. The tool was validated by modelling and simulation of three million pilgrims based on a strict scheduling system that distributes them on each level. Based on our methods of allocating specific evacuation routes at each level on the bridge, the evacuation modelling shows promising results when using six towers, resulting in a smooth process without any crowd buildup.

4.1. Introduction

Given the inevitable overcrowding, Mass Gathering (MG) events pose substantial challenges to organisers and relevant authorities in relation to crowd management, security, and emergency preparedness (Memish et al.,2012). These events attract crowds varying in size and complexity, and their planning and management need to account for spatial-temporal constraints (Aitsi-Selmi et al., 2016). Yet, crowd hazards and accidents have been recorded at many MGs (Aitsi-Selmi et al., 2016).

Hajj is one of the largest MG events worldwide and occurs annually usually with more than two million pilgrims (Reffat, 2012; Friberg and Hjelm, 2014; Haase et al., 2019). Hajj takes place annually, in Makkah, at a very specific time, during the 8th-12th of Dhulhijjah, the last month in the Islamic

³ This chapter was published in the 24th International Congress on Modelling and Simulation, Sydney, NSW, Australia, 5 to 10 December 2021.

calendar (Yamin and Albugami, 2014). Hajj events consist of specific, fixed sequence of rituals at fixed locations and with strict spatial boundaries. In 2020 and 2021, due to the COVID-19 pandemic, the event was substantially reduced in size; yet, it is expected that numbers comparable to pre-2020 will return at Hajj in the post-pandemic era.

A number of features make Hajj a unique event: sheer size of the attendance; heterogeneity of the pilgrims; and specific order and time windows of the rituals. Managing the Hajj is a difficult, multifaceted task (Osman and Shaout, 2014). Pilgrims have different cultural backgrounds, speak different languages, and often display distinct and non-uniform behaviours during Hajj rituals (Alabdulkarim et al., 2016).

To manage pilgrim movements and ensure Hajj proceeds smoothly, the Ministry of Hajj, Kingdom of Saudi Arabia, has established six international establishments, an Arabic Gulf countries establishment, and an interior establishment (Khoziun et al., 2012), with responsibilities for pilgrims from designated countries. The Ministry of Hajj together with the Ministry of Municipal and Rural Affairs of the Kingdom of Saudi Arabia (MOMRA) are in charge of designing the Hajj crowd management plan (Haase et al., 2019).

The focus of this chapter is the Aljamarat ritual (Stoning the Devil at one or three pillars), performed during the 3rd, 4th and 5th days of Hajj (Yamin and Albugami, 2014) in the holy site of Mina. The Aljamarat Bridge is a physically constrained venue (as discussed in 4.1) and the ritual occurs on all five levels of the bridge, following a unidirectional movement system to prevent counter flows and obstructions (Alaska et al., 2017).

In the past (1986–2006), interactions among pilgrims at Hajj have led to crowd incidents, and even resulted in deadly stampedes (Al-Kodmany, 2013). This triggered infrastructure changes, but also better prior planning by the authorities, using various possible scenarios to account for unexpected events (Reffat, 2012; Alabdulkarim et al., 2016). In the case of the Aljamarat Bridge, the crowd management plan includes timetabling of activities; designating specific routes; and developing schedules for each of the pilgrim groups (of size 250), depending on the location of their accommodation in Mina City (Al-Bosta, 2011; Muller, 2015; Haase et al., 2019). These processes are implemented to control the flows of pilgrims, allowing only a certain number of pilgrims to enter the bridge at a given time (Alaska et al., 2017).

Many approaches to model the Aljamarat ritual have been proposed in the literature. Given the focus on assessing the overall safety and efficiency of the ritual within the Hajj sequence, this chapter models the rituals at the Bridge and develops evacuation scenarios from the bridge using Discrete Event Simulation (DES).

The structure of the rest of the chapter is as follows. A review of related work of crowd modelling and simulation at Aljamarat Bridge and previous evacuation studies using DES or other simulation techniques is given in the next section (Section 4.2). The chapter then describes the Methodology (Section 4.3) and the implementation of the model using the ExtendSim software (Section 4.4). Evacuation scenarios are explored and then results are presented in the Discussion (Sections 4.5 and 4.6). The chapter concludes with a summary of the findings and recommendations for practice and future work (Section 4.7).

4.2. Related work

Owaidah et al. (2019) reviewed important crowd modelling and simulation studies for Aljamarat Bridge for both normal and evacuation situations. The design of the Aljamarat Bridge is a 5-level structure (Still and Algahdi, 2003; Felemban et al., 2020). The modelling of the new bridge was done using Legion and Myriad 2 Agent-Based Modelling (ABM) packages, considering a maximum level of service of 4 pilgrims/m², a widely used international safety standard (Still and Algahdi, 2003). Legion was used for modelling and simulating crowd evacuation scenarios, and Myriad 2 for the evacuation, considering three different options: a random exit; the nearest exit; and all pilgrims choosing the same exit (Still, 2000; Al-Kodmany, 2013). This modelling focused on simulating normal and emergency evacuations as a worst-case emergency scenario. Each level is connected to towers, however the rates (p) of pilgrim evacuation for each level differ across the towers of the bridge: level 1= 7,515 p/min; level 2= 5,295 p/min; level 3= 3,419 p/min; and level 4= 3,375 p/min (Still and Algahdi, 2003).

Klöpffel (2007) used another crowd modelling software (PedGo) for modelling and simulating crowd evacuation from the new Aljamarat Bridge, providing the duration of the evacuation (walking time) and distance covered by the evacuees during the process (Klöpffel, 2007). One of the worst-case scenarios was to evacuate 100,000 pilgrims (400 groups) evenly distributed on the bridge. The simulation showed

the evacuation using the nearest exits took 10 minutes (Klöpffel, 2007), and assumed that all pilgrims were aware of all the nearest exits on the bridge and took the shortest path to these exits (Klöpffel, 2007).

Recently, Alazbah and Zafar (2019) proposed an ABM framework (using AnyLogic) to model and simulate congestion around Aljamarat Bridge pillars. They generated heterogeneous crowds of pilgrims (consisting of males and females, children, elderly, strong and weak), organised in groups that moved at different speeds. When groups do not finish their ritual according to the scheduled time, congestions at the bridge could occur. Hence, the authors simulated pilgrims and their behaviours at three crowd densities, normal, semi-crowded and crowded. The simulation considered agents interacting with the surrounding environment on the Aljamarat Bridge, including obstacles and other pilgrims. To assess the congestion on the bridge, the authors used the level of service (LoS), rated from A (free walking) to F (stampede). Their proposed solution was to signal the congestion levels using the traffic light model, green indicating comfortable walking, orange indicating moderate speeds and red indicating congestion. The paper did not report the number of pilgrims simulated in the model, nor any detailed results from the simulation (time spent inside the bridge, duration of the ritual and walking, whether the model considered normal or evacuation conditions).

The focus of this chapter is to model and simulate the pilgrims at Aljamarat Bridge and test emergency evacuation scenarios using “ExtendSim”, a DES tool.

4.3. Methodology and data sources

ExtendSim is a general-purpose simulation tool that provides a range of methodologies, such as, continuous; discrete event; discrete rate; and ABM simulations (Krahl, 2009; Krahl, 2012; Diba, 2018). ExtendSim is powerful platform for DES has been used to model a wide variety of systems, including manufacturing, healthcare, communications, logistics, or military services (Krahl and Nastasi, 2014). The basic idea for the model is that an item, progressing through the model, can be thought of as a workgroup which moves from block to block and performs a certain type of work (Briggissson, 2009). The type of workgroup depends on the attributes assigned to the item (Briggissson, 2009). ExtendSim was used here to analyse the sequenced activities of the stoning ritual at the Aljamarat Bridge. The ritual consists of entering the bridge (at a certain level depending on the pilgrim schedule), stoning the three pillars (which requires walking from one pillar to the other and queueing for stoning performance) then exiting the

bridge. ExtendSim was used for our previous study (Owaidah et al., 2021) in modelling the Tawaf and Sayee rituals at the Grand Mosque at the beginning of the Hajj event.

Secondary data were obtained from The Institute of Hajj and Umrah Research and Ministry of Hajj, Makkah, Saudi Arabia. Various sources, statistics, reports, images, and video recording from Hajj 2015, 2016, 2017, and 2019 were used to validate the model.

4.4. Modelling and Simulation Implementation

4.4.1. Aljamarat Bridge Features

The current Aljamarat Bridge was built between 2006 and 2010 (Al-kodmany, 2013). It is 950m long and 80m wide. Levels 1 to 4 are each about 12m high and there are about 10m from level to level (Edrees, 2016; Alaska et al., 2017). There are 11 entry points, 12 exits, and six service towers along the bridge, including two helipad towers for medical emergency and emergency evacuation (Muller, 2015; Edrees, 2016). The bridge is designed to accommodate a maximum throughput of 125,000 pilgrims per hour per level (Ilyas, 2013). Each level of the bridge contains three pillars, each represented by a 26m long wall: Al-Sughrah (small pillar); Al-Wustah (middle pillar); and Al-Kubrah or Al-Aqabah (large pillar) (Al-kodmany, 2011; Haase et al., 2019). The distance between the small and middle pillar is about 135m, and between the middle and large pillar is about 200m (Al-kodmany, 2011; Al-kodmany, 2013) as shown in Figure 4-1. Each side of the pillars allows for a maximum 788 pilgrims to perform the ritual at any time (Al-Haboubi, 2003).

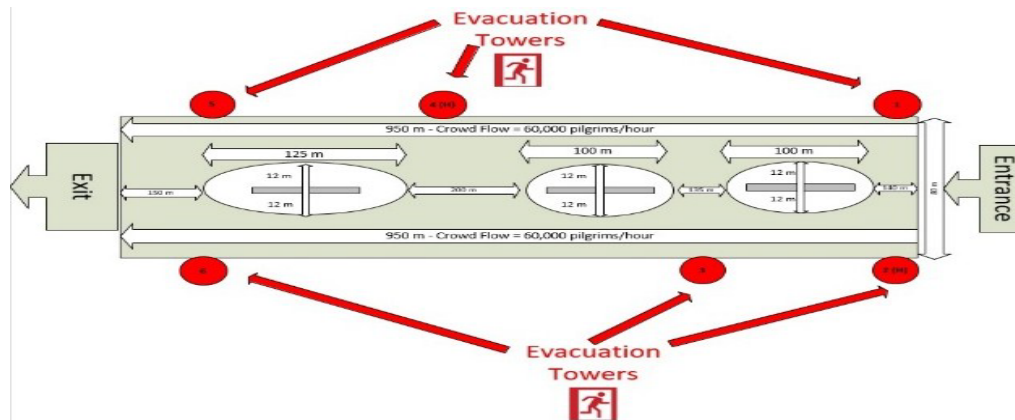

Figure 4-1: Aljamarat Bridge features (in a level) (Authors' elaboration)







At each pillar, pilgrims approach the target, positioning themselves at the edge of the basin surrounding the pillars (about 12m from it). They then pelt the pillars (walls) with seven pebbles. On the 10th day only the first pillar is pelted, but on the next two days (11th and 12th) each pillar is pelted with seven pebbles (Al-kodmany, 2011). Peak crowds for the ritual are around noon on each day (Al-kodmany, 2011).

Pilgrim groups are allocated specific routes for access, entry points, and levels for the ritual (Al-Bosta, 2011 and Al-Kodmany, 2011). The ground and 1st floor of the bridge are used by pilgrims entering from the eastern side (from Mina tents or camps, 60% of the pilgrims); the 2nd floor is used by the pilgrims coming from the western side (from Makkah, 10%); the 3rd floor is used by the pilgrims coming from the North of the bridge (from Almouasim tunnel, 20%); and the 4th floor is used by the pilgrims coming from the southern side (Al-Aziziah district, 10%).

4.4.2. Aljamarat Bridge Three Pillars model: attributes, conditions and main ExtendSim blocks

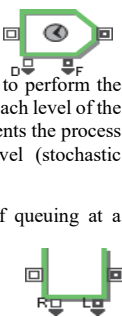
Evacuating mass crowds requires a safe, rapid, and smooth movement of a large number of participants from an area (a big arena, building, train station, city) when a dangerous situation arises (Friberg and Hjelm, 2014). This is independent of the nature of the danger (natural disasters, infrastructure accidents/failures, fires, attacks, etc.). For the Aljamarat Bridge, the following attributes, conditions, and blocks were used for the evacuation simulation: pilgrim establishment, age, walking speed, incident rates, distances, duration of ritual (stoning/pelting a pillar), and congestion conditions. They are detailed in Table 4-1. (Full model is available at: <https://cloudstor.aarnet.edu.au/plus/s/n4abSUEMtE1qJXH>).

Table 4-1: Main types of blocks included in the simulation model

ExtendSim Blocks and description	
<p><i>Attribute blocks (Set and Get):</i></p> <ul style="list-style-type: none"> • Pilgrims' groups and regions (pilgrim groups and their numbers at Hajj 2019 are found in (Owaidah et al., 2021). • Age (pilgrims between 10-50 years represent 40% and 50+ represent 60%) (Owaidah et al., 2021). • Speed/velocity. Represents pilgrims speed by the two main age categories, considering three fitness levels (fit, tired and very tired) (Dridi, 2015; Owaidah et al., 2021). The maximum observed speed for Hajj in 2006 on the new Aljamarat Bridge was 1.5m/s, substantially higher than on the old bridge, 0.5 m/s (Helbing et al. 2007; Haase et al., 2019). In this simulation, speed is reduced for elderly pilgrims by a factor of 0.83 (compared to 10-50 years). • Time spent on Aljamarat Bridge: duration spent on the bridge is calculated from when pilgrims enter the bridge and until they leave the bridge. Stoning process at each pillar takes about 1 minute, including 30 seconds for throwing pebbles and 30 seconds supplications (prayers) (Ilyas, 2013). The simulation uses triangular distributions of durations. • Speed/Time: age group 10-50 = 1.33 m/sec (for Turkey, Europe, North and South America and Australia (TEAA)) and 1.46 m/sec for the other groups. These speeds are applied when pilgrims are fit. • Fitness levels: 0 = fit, 1 = tired and 2 = very tired. When pilgrim fitness changes from fit to tired, the speed decreases and a time factor of 1.11 is applied. When fitness changes from tired to very tired, the time factor is 1.25. • Incident rates: This varies by group, with pilgrims from areas outside Saudi Arabia generally less familiar with the Hajj conditions and often contributing more to accidents during Hajj. Bianchi (2017) reported that eight countries represent 75% of the total number of Hajj pilgrims for the last 14 years. These countries are listed with their incident rates in (Owaidah et al., 2021). Arab = 0.23%, Southeast Asia (SEA), South Aisa (SA) and Iran = 0.74%, Africa = 0.18 % and Europe = 0.7 %. 	
<p><i>Select Out and Select In blocks for groups allocations or combinations</i></p>  <p>Each pilgrim group is allocated and scheduled an entry to Aljamarat Bridge depending on their accommodation and paths to the bridge. GL and L1 receives Arabic Golf, Arab, SEA, SA, Iran, Africa and Locals, L2 Arab and Locals, L3 Arab, SEA, SA, Iran, TEAA and Locals and L4 SEA, SA, Iran and Locals.</p> <p><i>Select Out</i> blocks were included for the allocation of the pilgrims to the levels they may use, as</p> <ul style="list-style-type: none"> • L3 • GL and L1 • GL, L1, L2 and L3 • GL, L1, L3 and L4 <p><i>Select In</i> blocks were used to combine streams of pilgrims using the same level.</p>	<p><i>Activity and Queue Blocks</i></p> <p><i>Activity Blocks</i> are used to represent activities such as walking or stoning the pillars. In this model, all activity blocks are set to a maximum 60 groups to perform the activity (based on the space available on each level of the bridge). <i>Stoning (activity) blocks</i>: represents the process of stoning/pelting a pillar on each level (stochastic process with an average of 1 min).</p> <p><i>Queue blocks</i>: represents the process of queuing at a pillar on each level.</p> 
<p><i>Equation blocks</i></p> <p>Walking to a pillar: These blocks are included to calculate the walking time to reach each of the pillars (e.g., the large pillar 3 is 700 m from the entrance) at each level of the bridge.</p>  <p>A random component was added in each situation to account for other influences in the duration of movement and rituals (e.g., heterogeneity within each group, possible crowding – LOS over 4 pilgrims/m²). To calculate the walking time, the equation blocks consider simplified movement conditions. An example is provided here:</p> <pre> if(Incident==0) walktime = (d/Average speed)/ReduceSpeed*Tired factor; else walktime = 2*(d/Average speed)/ReduceSpeed*Tired factor; </pre>	<p><i>Plotter blocks: Plotter block</i>: provide information of the simulation performance and outputs.</p>  <p><i>History blocks</i>: provide information of the simulation performance and outputs.</p>  <p><i>Exit blocks</i>: there are five of these blocks at each level representing the exits of the bridge, as well as six blocks for the evacuation towers.</p> 

4.5. Model Validation and Developing Evacuation Scenarios

Cuesta et al. (2016) indicated three methods used to develop new scenarios for evacuation models: applying legacy models; improving current models; or developing new evacuation models. In addition, the evacuation scenarios consider how human movement is incorporated, either as flow-based, cellular automata (CA), ABM, or activity-based models; also, the level of aggregation could be macro-, micro-,

and effect-based. Our choice was to modify a ‘base’ model and develop a new evacuation model, using the six evacuation towers in the process, which is different from the normal exits from the bridge by levels. Our research approaches the activity-based and macro-level description for a new model, to offer managerial solutions in case of evacuation at the Aljamarat Bridge. Figure 4-2 provides the location of the towers, all of them with the same capacity. The evacuation model was built on a validated model, incorporating additional Activity blocks to mimic pilgrim movements to the nearest towers during the evacuation process. These blocks are linked to Equation blocks specifying the walking times to the towers.

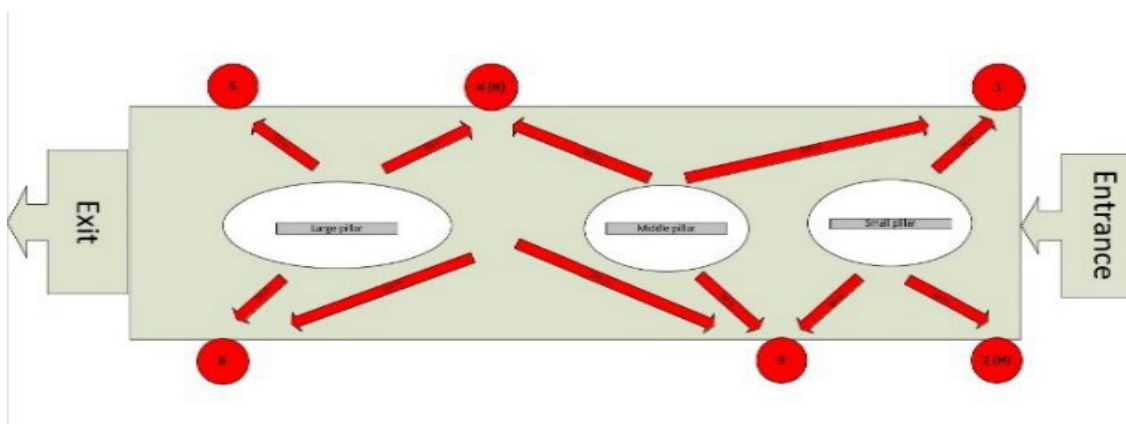

Figure 4-2: Evacuation exits and pathways (Authors' elaboration)

As our model structure is similar to our previous work for Tawaf and Sayee rituals (Owaidah et al., 2021), we apply a limit on the evacuation speed as 1.5m/s. We assume that the groups proceed to the nearest tower from the location of evacuation and that they are informed through planning, training and messaging which the nearest tower is. A prior allocation is set, with simple rules such as no intersection of the evacuation pathways or balanced/ “as even as possible” utilisation of all exits. Pilgrims can access the towers from all levels, whereas the ramps have direct access only to certain levels. The evacuation scenarios tested in this model evacuates pilgrims from all levels using the evacuation towers.

4.6. Discussion

Validated model showed that the completion of the ritual of stoning the three pillars in a safe manner, mimicking the three million pilgrims, can be achieved in 22 hours (average of more than 100 runs). This is because all pilgrim groups followed strict scheduling and each group was able to finish their ritual within 12-14 minutes, assuming no crowding. As a result, the ritual was completed in less time than at the Hajj 2019 and less than the simulation setup run (Table 4-2).

Table 4-2: Aljamarat Bridge Validation

Levels	Real Data 2019	Sim. results	Diff. %	Real Data 2019	Sim. Results (min)	Diff. (from60 min) (min)
	Percentages of pilgrims/24h (%) and number of groups (in brackets)			Av. and std.dev. duration of ritual activity for each group (entering thebridge, walking between the pillars, stoning all pillars and exiting) (*)		
L4	10 (1,200)	9.38 (1,125)	-0.26	1-3 hours(*)	12.89 (1.88)	-47.11
L3	20 (2,400)	20.44 (2,452)	0.44		13.08 (2.03)	-46.92
L2	10 (1,200)	9.61 (1,153)	-0.39		12.93 (1.85)	-47.07
L1	30 (3,600)	30.36 (3,643)	0.36		13.76 (2.57)	-46.24
GL	30 (3,600)	30.21 (3,627)	0.21		13.89 (2.64)	-46.11

Note: * Alshammari and Mikler (2015)

Two additional models were tested with scheduled arrivals, but even use of the five levels; and with stochastic (Poisson arrivals across the day). The results confirm the expectation that even use of the levels leads to a better utilisation and a statistically significant reduction of 0.4 min, whereas the stochastic arrivals do not have a significant impact (substantial reserves of capacity on the bridge).

For the evacuation models, the following conditions were assumed:

- pilgrims about to enter the bridge are evacuated through the ramps (not proceeding through the five levels);
- pilgrims who finished the ritual exit the bridge according to the set pathways/ramps, but at a higher speed (a multiplier of 1.1);
- pilgrims performing the ritual at any of the five levels during evacuation will use one of the six towers on both sides of the bridge, as per allocation and instructions.

The results presented here refer to evacuating the pilgrims inside the bridge, which is the most challenging task, given the confined space. The evacuation scenario considered various numbers of

pilgrims on the bridge (scheduled or stochastic arrivals), and various number of towers being used for evacuation. The model explored the evacuation times, assuming several discrete starting times for the evacuation, every two hours (60 min, 180 min, etc. until the end of time window for the ritual). The results in Table 4-3 and Table 4-4 include the average evacuation duration from each tower from two scheduling scenarios, (scheduled arrivals and Poisson) considering a LOS on the bridge of 4 p/m². They also present the number of groups evacuated by tower, suggesting a balanced used of the facilities, through the rules included in the model (closest tower, no intersection of flows, no further incidents). Consequently, the average evacuation durations from all towers varied between 9.97 to 10.48 mins. The results show that the evacuation was carried out smoothly without any crowds building, as the total number of pilgrims on the bridge has not exceeded 327 thousand on the five levels. The larger durations for normal proceedings reflect the inclusion of the stoning ritual, which is not performed during evacuation. The pilgrim groups were exiting from the towers using paths designated for them (Figure 4.2).

Table 4-3: Duration of evacuation and number groups using six towers (scheduling scenario - BAU)

Evacuation starting time	Evacuation duration (min)	Average number of groups by tower					
		Tower 1	Tower 2	Tower 3	Tower 4	Tower 5	Tower 6
60	10.18	211	218	188	189	182	213
180	10.26	211	218	188	189	182	213
300	10.35	211	218	188	189	182	213
420	10.3	211	217	187	188	182	213
540	10.29	211	217	187	188	182	213
660	10.48	211	217	187	188	182	213
780	10.41	211	217	187	188	182	213
900	10.33	211	217	187	188	182	213
1,020	10.24	211	217	187	188	182	213
1,140	9.97	116	108	92	100	90	94

Table 4-4: Duration of evacuation and number groups using six towers (random arrivals – Poisson 600 groups/hour)

Evacuation duration (min)	Average number of groups by tower					
	Tower 1	Tower 2	Tower 3	Tower 4	Tower 5	Tower 6
10.20	223	243	210	207	199	226
10.28	220	234	204	200	191	224
10.37	215	231	198	198	188	220
10.29	209	215	187	188	177	210
10.29	214	221	193	193	186	218
10.3	214	221	194	193	186	218
10.29	207	215	185	187	176	208
10.35	211	218	188	190	181	214
10.29	214	223	194	193	186	218
10.32	214	225	196	193	186	218

Other evacuation scenarios were developed by generating the pilgrims' groups randomly, but at more intense rates, or with fewer (4-5) towers (results of closing a helipad tower can be found in the following link: <https://cloudstor.aarnet.edu.au/plus/s/oNadJiAWZwmZXY2>). The average evacuation durations from all towers were between 11.20 to 15.35 mins, depending on the number of towers available for evacuation. The results confirm the importance of scheduling method to control for crowd levels on the bridge and that by closing 1-2 towers, the evacuation takes much longer.

Figure 4-3 presents the duration of completing the ritual in normal conditions using scheduled arrivals according to the allocated distribution on the bridge (Table 4-2) and with even distribution across the five levels. Unsurprisingly, even use of the levels shows better flow of pilgrims on the bridge and no build-up congestion around the pillars, with an average reduction of 0.4 min the duration of the ritual. On the other hand, the duration of evacuation the pilgrims using scheduled arrivals and Poisson with an average rate of 600 groups/hour are similar, and slowly building up towards the end of the time window for the ritual.

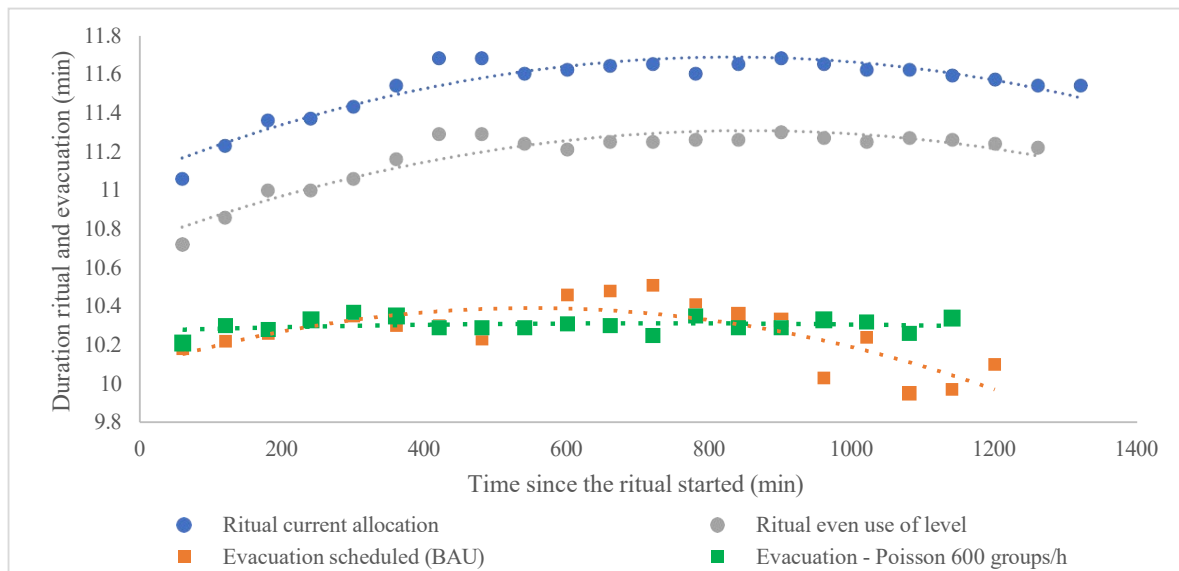

Figure 4-3: Evacuated pilgrims and evacuation (BAU) durations

4.1. Conclusion

The stoning ritual is performed at the Aljamarat Bridge during the last three days of Hajj. This bridge has witnessed serious crowd incidents in the past, which led to the reconstruction of the bridge in its current form to improve safety. Yet incidents can happen that can require pilgrims to be evacuated. This chapter focused on the development of evacuation modelling and simulation in case of any hazardous situations on the bridge, using DES tool (ExtendSim). The rituals can be performed under 14 min in normal conditions, and even distribution to the five levels improves the proceedings. In our models, we proposed that pilgrims can be evacuated using six towers linked to the bridge on both sides. During the evacuation, the pilgrims approach the nearest tower to exit by following easy directed routes that do not conflict or intersect with others. From the evacuation scenarios, it was noticed that the evacuated number of pilgrims in the scenario with random arrivals was higher than the number of pilgrims in the scheduled situation (status quo/BAU), although the evacuation time was comparable. The evacuation time increases when arrivals are intensified in the first part of the day of the ritual and when certain conditions may lead to closure of the helipad towers.

The scenarios showed in Figure 3 indicate evacuation times shorter than those reported in the Klüpfel study, which evacuated 100,000 pilgrims in 10 mins. The model did not present any crowd queueing and waiting during the evacuation because the bridge has enough capacity to accommodate the current number of pilgrims. However, closing helipad towers will increase the duration of the evacuation. Future research could focus on developing evacuation modelling from the Aljamarat Bridge on the first day of the stoning ritual, which requires stoning only the large pillar and a shorter time window (12 hours).

Acknowledgment

The authors are grateful to the Ministry of Hajj for providing data for this research. The authors would also like to thank Kathi Hansen, the academic representative of Imagine That Inc., for granting access to ExtendSim software for this research.

References

1. Alabdulkarim, L., Alrajhi, W., & Aloboud, E. (2016). Urban Analytics in Crowd Management in the Context of Hajj. In *Int. Conf. Social Computing and social media*, 249-257, Springer, Cham.

2. AlGadhi, S. & Still, K., 2003. Jamarat Bridge; Mathematical Models, Computer Simulation and Hajjis Safety Analysis. Technical Report, Crowd Dynamics Limited.
3. Al-Haboubi, M. H., 2003. A new layout design for the Jamarat area (stoning the Devil). *Arabian Journal for Science and Engineering*, 28(2), 131-142.
4. Al-Kodmany, K., 2011. Planning for safety: The case of the symbolic stoning of the devil in Hajj. *Journal of Architectural and Planning Research*, 28(1), 28–43.
5. Al-Kodmany, K., 2013. Crowd management and urban design: New scientific approaches. *Urban Design International*, 18(4), 282-295.
6. Alshammari, S. M. & Mikler, A. R., 2015. Modeling disease spread at global mass gatherings: Hajj as a case study. *2015 International Conference on Healthcare Informatics (ICHI)*. Dallas, TX, 574-577.
7. Aitsi-Selmi, A., Murray, V., Heymann, D., McCloskey, B., Azhar, E. I., Petersen, E., ... & Dar, O. (2016). Reducing risks to health and wellbeing at mass gatherings: the role of the Sendai Framework for Disaster Risk Reduction. *International Journal of Infectious Diseases*, 47, 101-104.
8. Cuesta, A., Abreu, O., & Alvear, D., 2016. Future challenges in evacuation modelling, in *Evacuation Modeling Trends*. Cham, Switzerland: Springer, 103-129.
9. Bianchi, R., 2017. Reimagining the Hajj. *Social Sciences*, 6(2), 2-26.
10. Diba, K., 2018. A comparative study of business process simulation tools. Master's thesis, University of Hasselt.
11. Dridi, M. H., 2014. Pedestrian flow simulation validation and verification techniques. *arXiv preprint arXiv:1410.0603*.
12. Edrees, M., 2016. The role of urban design in crowd control: Case study 'Jamarat area'. Available at https://www.researchgate.net/publication/310346287_The_Role_of_Urban_Design_in_Crowd_Control_Case_Study_Jamarat_Area
13. Felemban, E. A., Rehman, F. U., Biabani, S. A. A., Ahmad, A., Naseer, A., Majid, A. R. M., Hussain, O. K., Qamar, A. M., Falemban, R. and Zanjir, F., 2020. Digital revolution for Hajj crowd management: a technology survey. *IEEE Access*, 8, 208583-208609.
14. Friberg, M., & Hjelm, M., 2014. Mass evacuation-human behavior and crowd dynamics. Department of Fire Safety Engineering, Lund University, Sweden, 12.
15. Haase, K., Kasper, M., Koch, M., & Müller, S. (2019). A Pilgrim Scheduling Approach to Increase Safety During the Hajj. *Operations Research*, 67(2), 376-406.
16. Ilyas, Q. M., 2013. A Netlogo model for ramy al-jamarat in Hajj. *Journal of Basic and Applied Scientific Research*, 3(12), 199-209.
17. Klüpfel, H., 2007. The simulation of crowd dynamics at very large events—Calibration, empirical data, and validation. In *Pedestrian and evacuation dynamics 2005* (pp. 285-296). Springer, Berlin, Heidelberg.
18. Krahl, D., 2009. ExtendSim advanced technology: discrete rate simulation. In *Proceedings of the 2009 Winter Simulation Conference (WSC)* (pp. 333-338). IEEE.
19. Krahl, D., 2012. ExtendSim: a history of innovation. In *Proceedings of the Winter Simulation Conference (WSC '12)*. Winter Simulation Conference, 1-8, IEEE
20. Krahl, D., & Nastasi, A., 2014. Reliability Modeling with ExtendSim. In *Proceedings of the 2014 Winter Simulation Conference*, 4219-4225, IEEE.
21. Khozium, M., Abuarafah, A. & AbdRabou, E., 2012. A proposed computer-based system architecture for crowd management of pilgrims using thermography. *Life Science Journal*, 9(2), 377–383.
22. Memish, Z. A., Stephens, G. M., Ste_en, R. & Ahmed, Q. A., 2012. Emergence of medicine for mass gatherings: Lessons from the Hajj. *The Lancet Infectious Diseases*, 12(1), 56–65
23. Müller, S., 2015. Spaces of rites and locations of risk: the great pilgrimage to Mecca. In *The Changing World Religion Map*, 841-853. Springer, Dordrecht.
24. Osman, M., & Shaout, A., 2014. Hajj Guide Systems-Past, Present and Future. *International Journal of Emerging Technology and Advanced Engineering*, 4(8), 25-31.
25. Owaidah, A., Oлару, D., Bennamoun, M., Sohel, F., & Khan, N., 2019. Review of modelling and simulating crowds at mass gathering events: Hajj as a case study. *Journal of Artificial Societies and Social Simulation*, 22(2).
26. Owaidah, A., Oлару, D., Bennamoun, M., Sohel, F., & Khan, R. N. (2021). Modelling mass crowd using discrete event simulation: A case study of integrated tawaf and sayee rituals during Hajj. *IEEE Access*.
27. Reffat, R., 2012. An Intelligent Computational Real-time Virtual Environment Model for Efficient Crowd Management. *International Journal of Transportation Science and Technology*, 1(4), 365-378.
28. Yamin, M., & Albugami, M. A., 2014. An architecture for improving Hajj management. In *International Conference on Informatics and Semiotics in Organisations*, 187-196. Springer, Berlin, Heidelberg.

Chapter 5

Chapter 5 : Transport of Pilgrims During Hajj: Evidence from a Discrete Event Simulation Study⁴

Abstract

Hajj, the Muslim pilgrimage, is a large mass gathering event that involves performing rituals at several sites on specific days and times in a fixed order, thereby requiring transport of pilgrims between sites. For the past two decades, Hajj transport has relied on conventional and shuttle buses, train services, and pilgrims walking along pedestrian routes that link these sites. Hajj authorities use specific time windows, modes, and routes for specific groups of pilgrims. However, the large number of pilgrims, changes in bus schedules/timetables, and occasional lack of coordination between transport modes have caused congestion or delays in journeys between sites, with a cascading effect on transport management. This study focuses on modelling and simulating the transport of pilgrims between the sites using a discrete event simulation tool called “ExtendSim”. Three transport modules were validated and scenarios were developed. These scenarios consider changes in the percentage of pilgrims allocated to each transport mode and the scheduling of various modes. The results of these scenarios can inform relevant authorities on potential transport strategies to manage the transport infrastructure and fleets. The proposed transport solutions could be implemented with judicious allocation of resources by planning transport operations before the event and monitoring the use of these resources during the event.

5.1. Introduction

Well organised transport for mass gathering (MG) events is critical for ensuring enjoyable, safe, and incident-free proceedings, regardless of the nature of the events (e.g., sporting, cultural, religious, or political) or their location. However, any MG event poses distinct challenges that are amplified by the size of the event (World Health Organization 2015). Hajj, which lasts for five days, is the largest annual MG event in the world, attracting millions of pilgrims to the sites of Makkah, Mina, Arafat, and Muzdalifah in Saudi Arabia (Koshak 2006; Seliamam et al. 2013; Tayan and Al-Binali 2013; and Felemban et al. 2019b). The pilgrims need to perform a sequence of rituals at the specific sites and within

⁴ This chapter is under review in *Transportation Journal* (Springer).

a specific time window. This requires substantial crowd movements between sites (Al-Sabban and Ramadan 2005; Owaidah et al. 2019; Felemban and Rehman 2022). Pilgrims start their rituals at the Grand Mosque in Makkah, following which most go to their allocated camps in Mina where they spend the night. This is the first day of Hajj and corresponds to the 8th of the Islamic month of Zil Hijjah. On the 2nd day (the 9th of Zil Hijjah), they move (from Mina or Makkah) to Arafat to spend the whole day on Arafat Mountain, from where they must travel to reach Muzdalifah before midnight. After sunrise on the 3rd day, pilgrims return to Mina to perform the ritual of ‘Stoning the devil’ at Aljamarat Bridge; only the first of three pillars is stoned on this day. This is followed by the rituals of Tawaf and Sayee at the Grand Mosque in Makkah, and then return to Mina again. On the 4th and 5th days of Hajj (corresponding to the 11th and 12th of Zil Hijjah) pilgrims perform the ritual of stoning all three pillars at the Aljamarat Bridge. Pilgrims may now go to Makkah to perform their final Tawaf, which completes their Hajj.

The above description of Hajj provides an understanding of the complexity of issues pertaining to multiple movements of a large number of people in a short period of time, and possible overcrowding at Hajj sites. Koshak (2006) identified transport as the primary challenge faced by Hajj authorities in charge of the management and movement of pilgrims. The most frequently noted issue is the movement from Arafat to Muzdalifah (Al-Nafrah movement), wherein large numbers of pilgrims need to reach Muzdalifah within a window of some six hours (Geabel et al. 2014; Amer and Almatrafi 2019; Felemban et al. 2020). Although authorities have taken measures to improve operations over the years (e.g., vehicle scheduling, monitored access to train stations, and restricting access to the sites only to registered pilgrims and service personnel), the large number of pilgrims impacts the effectiveness and success of the transport management (Koshak 2006; Alshalani et al. 2020; Felemban and Rehman 2022).

Fixed and limited road networks, and the often-insufficient bus capacity versus demand lead to congestion and traffic jams. These conditions have increased travel times, created bottlenecks, and affected the air quality in the entire area. Therefore, novel solutions for pilgrim transport between the Hajj sites have been proposed (Seliamam et al. 2013; Mohsen and Shihatah 2012; Tayan and Al-Binali 2013).

Currently, with the cooperation of Hajj transport department (Ministry of Hajj) and the Hajj traffic department, transport is managed and organised by the Tawafa Establishments (TEs). These establishments transport the pilgrims between the sites using designated transport modes and strictly

follow transport schedules developed prior to the beginning of Hajj (Felemban et al. 2019a; Felemban et al. 2019b; Felemban and Rehman 2022).

Hajj authorities require careful prior planning to control pedestrian and vehicle movements and avoid traffic congestion and other incidents (Koshak 2006). The Hajj Traffic Plan includes provisions to facilitate the movement of buses and other collective transport vehicles in Makkah (HajjCORE 2010; Felemban et al. 2019a and b). Pilgrim scheduling is one of the measures adopted to ease congestion and avoid overcrowding (Al-Yagubi 2015; Jamil et al. 2015; Amer and Almatrafi 2019; Owaidah et al. 2019; Felemban and Rehman 2022).

Simulation studies are an important resource to inform and facilitate planning and scheduling. This chapter focuses on applying Discrete Event Simulation (DES) using the “ExtendSim” software to model transport movements and develop scenarios. We combine Hajj transport systems (buses, trains and pedestrian routes) linking the different sites of Hajj rituals jointly into a single module. The findings are expected to provide insights to improve current transport management at Hajj, and to prepare for unexpected situations that may arise during transport of pilgrims between sites.

This chapter is structured as follows. In Section 5.2 we describe current Hajj transport systems and compare them with transport for other MGs events. Literature review in Section 5.3 highlights the relevant case studies and the most frequently applied transport modelling techniques. In Section 5.4, we describe our research methodology, its rationale, and the description of the DES module design and validation. This is followed by a discussion of the simulation results, a description of the transport scenarios and our key findings. Finally, the chapter concludes with general insights from the modelling exercise, acknowledges limitations and provides directions for future work.

5.2. Hajj transport management

Most Hajj related studies focus on rituals as they are considered the most challenging aspects of the Hajj (Geabel et al. 2014; Fourati et al. 2017; Owaidah et al. 2019; Alshalani et al. 2020; Felemban et al. 2020). The closest events in terms of complexity and scale are large sport events such as the Olympics or FIFA World Cups. An analysis of these events may offer a better understanding of the common issues faced by organisers of MG events and potential solutions that can be adapted to ensure safe and efficient transport of Hajj participants.

5.2.1. Hajj vs the Olympics transport management

An examination of transport management and operation during the Olympics highlights that good transport planning, which is a condition set by the International Olympic Committee (IOC), requires a single agency to oversee the transport system (centralised command and control) (Kassens-Noor 2010, 2016; Kassens-Noor and Fukushige 2018). This agency collaborates with the government departments or authorities and private companies, which invest in infrastructure several years prior to the events, to ensure adequate capacity of both accommodation and transport (Kassens-Noor 2010, 2013, 2016).

The athletes are provided accommodation within specially-built villages to minimise travel times and ease access to the sport venues. Athletes and officials usually travel to the venues in buses along dedicated lanes. Visitors travel from their accommodation areas to the competition venues by point-to-point or loop mass transit systems with high frequency services. For example, in Sydney at the 2000 Olympic Games, 400,000 people per hour were transported by train at peak hours. Many road projects were funded to expand existing capacity (multiple lanes or new routes or new infrastructure such as in Sydney and Athens (Kassens-Noor 2013, 2016). Operational changes were implemented in all Olympic cities since 2000 to improve and regulate traffic flow, such as converting two-way into one-way streets, dedicated lanes and applying financial instruments (such as tolled roads). For the Japan Olympics in 2021, technologies such as Vehicle Information and Communication System (VICS) and Advanced Mobile Information Systems (AMIS) were implemented to analyse real-time data more ‘intelligently’ (Kassens-Noor and Fukushige 2018).

Similar substantial infrastructure changes have been implemented in Makkah, in particular at the Aljamarat Bridge, as well as improvements to roads and the introduction of the train services (Currie and Shalaby 2012). Yet, despite comparable numbers of participants and concentrated movements in space and time, Hajj has substantial differences in transport management compared with sport events, as highlighted in Table 5-1 (Kaseens-Moor 2010).

Table 5-1: Comparison between sport events and Hajj [based on Kassens-Noor (2010)]

Comparison factors	Sporting events (Olympics and World Cup)	Hajj
Frequency of the event (some location)	Every four years in different cities	Annually at Makkah city
Primary transport mode	Rail and buses	
Number of transported people	Transporting hundreds of thousands to millions in a short time interval	
Travel routes	Transport of competitors between airport, accommodation and sports venues	Transport between the Hajj holy sites of Mina, Arafat and Muzdalifah, constrained by limited roads and pedestrian routes and train capacity.
Transport regulations	Dedicated bodies for transport management, including traffic monitoring, control, and central communication for efficient and real-time transport decisions.	The Ministry of Hajj, General Cars Syndicate (GCS) and the Tawaf Establishments are responsible for Hajj transport. Bus companies used for pilgrim transport must be registered to GCS systems to obtain relevant permits and comply to their rules.
Traffic operations and management	Host cities invest in Traffic Management Centres (TMC), implementing the latest Intelligent Transport Systems (ITS) to coordinate transport and especially traffic flow. Traffic restrictions may apply in certain zones., High occupancy vehicle (HOV) lanes as well as variable messaging signs are used to improve traffic flow. Multiple operational measures are applied to reduce traffic, including parking control, dedicated bus networks, promotion of public transport (PT), as well as reduced travel demand by encouraging working-from-home, extending school holidays, or supporting vacations.	Private vehicles are banned from entering the central area of Makkah and Holy sites during Hajj. High occupancy vehicle lanes are not considered; instead access to sites is only by public transport, walking, or park-and-ride (PnR) for locals. Several lanes are converted to one-way to enable flow of traffic. The GCS is responsible for vehicles for transport, monitoring bus movements and breakdown recovery. An electronic platform is used for traffic monitoring
Transit operations and management	Transit operations include: <ul style="list-style-type: none"> • rail systems. • bus services on dedicated lanes, called "Olympic priority lanes", to sporting venues from airports, main railway stations, accommodation, and to other city attractions. other PT for visitors and residents to reach the sporting venues.	Transport between Hajj sites is via 2/47 buses, rail system and walking.
Public transport use	Transport is free for Olympic ticket holders, who may use any travel mode before, during and after the event.	Prior to arrival pilgrims purchase one of the eight transport packages offered for PT during Hajj; cost ranges between SAR240 and SAR535 (USD64-143).

Currie and Shalaby (2012) added more transport management differences between Hajj and the Olympics events to this list. While the Olympics venues change for each game, the Hajj venues remain fixed. This latter aspect allows planning for Hajj by accumulating knowledge, incorporating lessons from previous events in the planning of future events, incremental additions and improvements in infrastructure, and incremental improvements in procedures. Cities hosting sporting events become congested with visitors with significant crowding but not to the same extent as Hajj sites. Consequently, Hajj has often experienced dangerous conditions (such as bottlenecks, crowd turbulences and stampedes) at several holy sites, which further highlights the need for adequate planning. Currie and Shalaby (2012) also pointed out the importance of education and training programs for participants and spectators used for the Olympic. These are less developed for Hajj, the focus being more on group leaders who are responsible for groups of about 250 pilgrims from the beginning to the end of Hajj.

5.2.2. Management of Hajj

Hajj authorities and researchers have been investigating innovative ways to provide better crowd and transport management strategies (Felemban et al. 2020). One of the most notable aspects of Hajj is that the Saudi government plans to ensure Hajj proceeds in a smooth manner by implementing new solutions every year. These measures are based on studies and analyses of the experience from previous years (Felemban et al. 2020). The annual process includes four phases: 1. Planning (before Hajj); 2. Operation and 3. Monitoring (during Hajj); and 4. Analysis (after Hajj). The Hajj transport management team organises and schedules the pilgrims in groups and assesses the performance of rituals, transport and accommodation using quality indicators. These indicators represent the starting point for the planning for the following year (Currie and Shalaby 2012; Jamil et al. 2015). Crowd and transport modelling and simulation are undertaken during this planning phase of Hajj and they feed into the Operation and Monitoring for the next Hajj.

Six Hajj authorities are involved in traffic and transport planning: the Ministry of Hajj; Traffic Police (General Security); the Ministry of Transport; GCS or Naqaba; Tawafa Establishments; and bus drivers (Koshak 2006). Seven TEs are assigned to accommodate pilgrims in designated areas and organise their transport through specific modes and routes (Felemban et al. 2019b; Felemban and Rehman 2022).

The GCS organises pilgrim transport during Hajj and supervises the national transport companies. They have developed an electronic platform called “Daif” to organise Hajj transport by tracking each bus, identifying their locations and status; whether it is online, offline, moving, stopped, engine working, or suffered breakdown (Miralam and Jaziri 2019). This system is also used by the TEs and the transport companies to cooperate with GCS (Miralam and Jaziri 2019). The GCS manage nearly 20,000 buses (Kassens-Noor 2010; Sehli et al. 2016; SPA 2019d; Felemban et al. 2019b), as described in Section 5.2.3.1.

5.2.3. Transport modes used during Hajj

Pilgrim travel between the sites by buses, trains, or on foot (Al-Yagubi 2015). This requires well-developed and managed transport network and services (Figure 5-1), which Mohsen and Shihatah (2012) described as follows.

- The three main roads in the northern part of the holy sites are dedicated to shuttle buses that serve four groups: Turkey, Europe, America, Australia (TEAA); Southeast Asia (SEA); Iran; and Africa.
- *Trains* connecting the holy sites in the southern part. Where train lines intersect with roads, the railway is elevated. The trains serve four groups as well: the Locals; Arabic Gulf; TEAA; and South Asia.
- *Pedestrian routes* pass through the center of the holy sites, connecting the Namirah Mosque in Arafat and Aljamarat Bridge in Mina.
- Several roads, located north and south of pedestrian routes, are assigned to conventional buses, used to transport all pilgrim groups.

The allocation of different travel modes is based on the capacity. For example, using data from the 2011 Hajj, Mohsen and Shihatah (2012) estimated that: 17% of the pilgrims (500,000) used train, a third (one million) used shuttle buses, another third (one million) used conventional buses, and the remaining 428,000 walked between the holy sites.

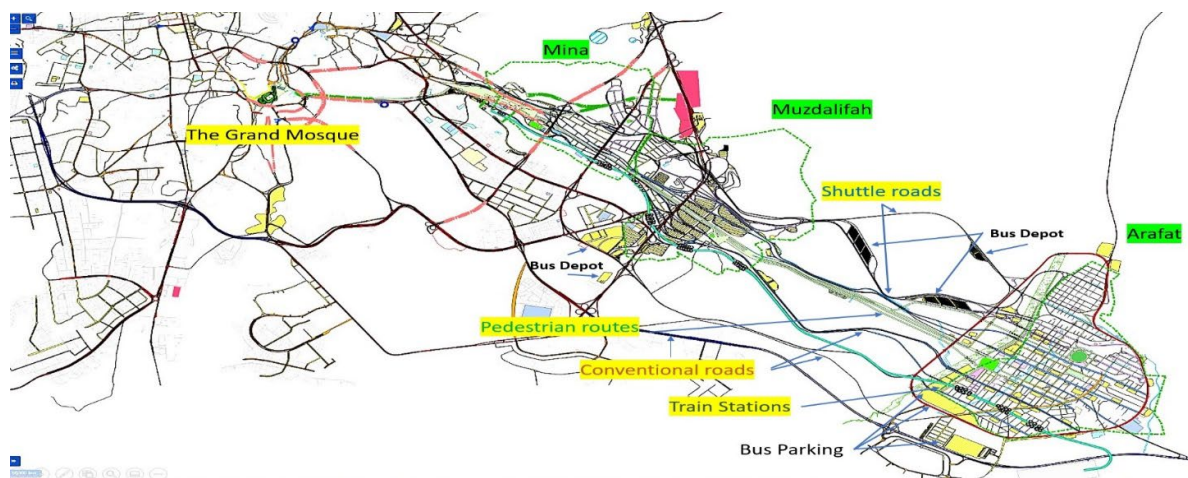

Figure 5-1: Hajj transport network (routes for buses, trains, and pedestrians) (www.Hajjtraffic.com)

Note: The road network connecting Arafat consists of nine main roads (Al-Gadhi 2001; Edrees 2017), of which seven (roads 3 to 9), with lengths between 7 and 10 km are linked to Muzdalifah (Edrees 2017). The maximum speed on these roads is 60 km/h and each road's capacity is 800 buses/h (Al-Gadhi, 2001).

5.2.3.1. Conventional and shuttle buses

Traditional (conventional) bus services make one or two trips per day to transport specific groups of pilgrims between holy sites, whereas shuttle buses make between three and nine round trips on two-way dedicated roads (Shalaby et al. 2013). The primary purpose of shuttle buses is to run continuous services with fewer buses and achieve better on-time scheduling. Because the trips are much shorter, faster and not affected by congestion or interference from pedestrians, shuttle buses are also expected to reduce air pollution within and around the holy sites (Hanrahan 2015; Hajj-information 2017). The trip between Arafat and Muzdalifah takes between 20 mins to 195 mins on a conventional bus (Seliaman et al. 2013), but less than 20 mins on a shuttle bus. Therefore, shuttle buses ease the traffic and improve the satisfaction of pilgrims (Al-Sabban and Ramadan 2005).

5.2.3.2. Train operation

In 2009, a new railway system (Al-Mashaaer Al-Mugaddassah railway) was built to assist the transport of pilgrims to Mina, Arafat, and Muzdalifah. The railway is 20 km long and comprises nine stations (three each at Mina, Muzdalifah, and Arafat) (Kaysi et al. 2013). The objective of the railway was to solve the problem of pilgrim overcrowding, eliminate bottlenecks and heavy traffic congestion, and improve the logistics infrastructure of the holy sites (Kaysi et al. 2012; Edrees 2017; Fourati et al. 2017). The railway line became partially operational during the 2010 Hajj season, at below full capacity (Shalaby et al. 2013; Kaysi et al. 2013). The current capacity of the railway is approximately 72,000 passengers/hour, equivalent to 30,000 buses (Haase et al. 2016; Imam and Alamoudi 2013).

5.2.3.3. Pedestrian routes between the holy sites

A substantial number of pilgrims walk between sites. Table 5-2 presents the details of the main pedestrian routes between the holy sites (Mohsen and Shihatah 2012) (see Figure 5-1). Although the distances are between 5 km and 12 km only, heavy traffic and the weather conditions (such as unbearable heat) make walking slow and pilgrims often take several hours to reach their destinations.

Table 5-2: Pedestrian routes at Hajj (Mohsen and Shihatah 2012, p. 10)

From	To	Direction of route	Distance (km)	Walking duration (h)	Pilgrims per hour (p/h)
Mina	Arafat	One-way	11.62	7	69,000
Arafat	Muzdalifah		6.85	4	80,000
Muzdalifah	Aljamarat Bridge – Mina		5.38	3	40,000
Aljamarat Bridge – Mina	The Grand Mosque	Two-way	6.70	4	20,000 each direction

5.2.4. Transport problems at Hajj

Owing to the large number of pilgrims, in 2019 the Hajj authorities decided to begin transport activities a day earlier (Department of Transport at Ministry of Hajj 2019). However, this proved insufficient. The 2019 statistics indicated that the scheduled transport duration was exceeded for most groups (Table 5-15 - Appendix). The SEA group required 26h longer than scheduled to complete the movement from Makkah to Arafat on the 8th and 9th of Zil Hijjah. For the African group, the actual time to complete the trip on the 7th and the 8th was 6h more than planned.

Two exceptions are noted. 1. The Iranian group required fewer hours on the 8th from Makkah to Mina and on the 9th to Arafat than planned, but an extra hour for their trip from Makkah to Arafat on the 9th. 2. The TEAA group required 12h less on both the 7th and on the 8th. However, TEAA group needed an extra 7h to complete the activities on the 8th and the 9th and 2h more than planned to travel from Mina to Arafat.

Additional issues include breakdowns and incidents (Al-Sabban and Ramadan 2005; Reffat 2012; Koshak and Nour 2013; Fourati et al. 2017; Amer and Almatrafi 2019; Miralam and Jaziri 2019; Alshalani et al. 2020)⁵. To avoid congestion on roads caused by incidents and bus breakdowns, the “Daif” platform stores the geolocation of each bus and quickly communicates solutions to remedy incidents (Miralam and Jaziri 2019).

Given the differences between planned times and resources and those required and recorded during the event, it is both valuable and timely to develop strategies to be able to quickly alter the schedules and evaluate their impact on Hajj transport.

⁵ There were no specific data on bus breakdowns and incidents in our data collection of Hajj 2019.

5.3. Relevant Literature for Simulation

Simulation models enable us to study and understand the function or behaviour of a system over time (Sharma 2015). Simulation presents several advantages, including providing an understanding of the occurrence of a specific event, enabling the testing of hypotheses, and allowing users to experiment with complex systems. The knowledge gained could assist users in solving problems identified within the systems (such as inadequate infrastructure and processes), and most importantly, to develop scenarios for future behaviour of the system without disturbing or interfering with the real system or wasting resources (Tayan 2010). Transport modelling can assist transport managers in planning, proposing and evaluating alternative solutions for traffic congestion by using existing networks and vehicles more effectively (Seliman 2001). However, this requires time, specialised skills, and appropriate software (Sharma 2015).

Plans for Hajj have increasingly relied on modelling and simulation for crowds and traffic (Felemban et al. 2020) to understand determinants of congestion, to offer suitable solutions for transport/movement between sites, thereby improving the management of operations (Tayan 2010). These plans are critical because the simultaneous movement of 3–4 million pilgrims and thousands of vehicles on (spatially constrained) roads networks could result in long queues (Felemban and Rehman 2022). Therefore, continuous development of transport plans and analysis of traffic movements can aid local authorities to make optimal decisions regarding transport during Hajj (Felemban et al. 2019a; Felemban and Rehman 2022).

Recent studies have focused on separate movements, particularly those under time constraints, such as the Al-Nafrah movement from Arafat to Muzdalifah. As early as 2001, Seliaman et al. (2001) highlighted that pilgrim movement between these two holy sites is a significant test for Hajj transport because it must be completed in approximately six hours, between sunset on the 9th and midnight of the 10th of Zil Hijjah. The authors developed a simulation model using the ProModel software and validated it with data from Hajj 1996. Their model suggested that 3,160 shuttle buses were required to transport pilgrims. However, the simulated number of transported pilgrims (153,000) was much smaller than the number of pilgrims participating in Hajj. Further, the distinct composition and nationalities of the pilgrims using the buses was not included in the simulations.

Another study on the Al-Nafrah movement conducted by Al-Sabban and Ramadan (2005) also reported congestion as one of the primary traffic challenges during Hajj. The average travel time between

Arafat and Muzdalifah in congestion conditions was estimated as three hours compared with only 10-15 minutes in normal traffic conditions. Therefore, the objective of their work was to evaluate any shortcomings associated with traffic management. They built a DES model in the Arena platform using data (bus boarding, alighting and travel times and bus frequency) from the 2002 Hajj. Pilgrims from TEAA were simulated in the model (160,000 pilgrims transported by 542 shuttle buses). The authors reported that the simulation model succeeded in presenting suitable traffic management strategies for the shuttle buses as shown in Figure 5-2. Their simulation results suggested that 500+ buses were needed for Al-Nafrah movement, which would last over 8h.

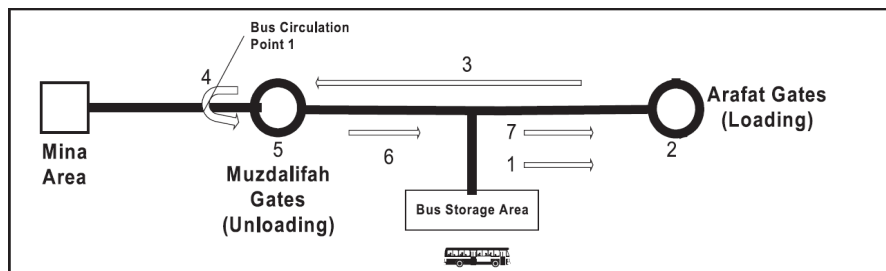

Figure 5-2 Movement 1 from Arafat to Muzdalifah from 6 pm on the 9th of Zil-hijjah to 2 am on the 10th (Al-Sabban and Ramadan 2005. p. 76)

However, this study used a DES module to simulate Hajj transport for only a single group using shuttle buses and excluded conventional buses. Further, only two movements (Arafat to Muzdalifah and Muzdalifah to Mina) were studied and did not include transport from Mina to Arafat.

Reffat (2012) developed a framework consisting of intelligent agents and real-time 3D virtual environment for traffic for the Al-Nafrah movement. The model focused on travel times on different roads between Arafat to Muzdalifah, offering spatial analysis of vehicle location and estimating outcomes of various traffic movement scenarios. For the validation process, the author collected data (number of buses on each road) from the Ministry of Hajj and Traffic Police, but the paper did not report the year considered for validation, nor the number of simulated pilgrims and their group membership. Although the paper mentioned other available transport modes (train and walking), these were not considered in the module.

A study by Koshak and Nour (2013) proposed a modelling framework using Radio Frequency Identification (RFID) technology and Geographic Information Systems (GIS) to monitor and provide

real-time information on 58 groups from TEAA using shuttle buses. Koshak and Nour (2013) did not perform modelling or simulation, but the approach of controlling, monitoring and managing Hajj transport systems using the combination of RFID and GIS is relevant to the transport operation. However, the study used only one pilgrim group and did not report the year of data collection.

Jamjoom (2017) highlighted the cascading effect of traffic congestion that leads to other challenges in managing Hajj, such as the late arrival of pilgrims at holy sites. The author developed scenarios of traffic movements between Arafat and Muzdalifah to optimise traffic and provide support for decision-making. The proposed Arena DES model was applied to evaluate traffic flows. The author used Google Earth images to accurately measure road distances on the network and reported movement data for the African and Iranian pilgrim groups. Even though they are starting at similar locations, the two groups are separated at the shuttle bus stops, they travel separately and meet again at Arafat. The in-vehicle travel time from Arafat to Muzdalifah was between 3.7 min to 5.6 min, corresponding to a speed between 40 to 60 km/h. The results of the first simulation (run time = 7.66 hours) indicated an average waiting time of 3.42 min. As an improvement, the authors decreased the boarding and alighting times and increased the utilisation for the highways between the two holy sites. The traffic performance increased by 6%, with bus speeds reaching 65 km/h, and the average waiting time reduced to 2.9 min (model run time = 7.27 hours). However, the author did not report the source of the data used in this study, the number of transported pilgrims and the number of buses used in the simulation.

Focusing more broadly on the transport management of the whole Hajj, Tayan et al. (2014) argued that many issues could affect the transport between the holy sites, including: limited capacity compared to the demand; temporal and spatial constraints at the holy sites; heterogeneity of the attending pilgrims; and their increasing numbers every year. The most challenging task for Hajj authorities is facilitating the transport of pilgrims from Mina to Arafat and later from Arafat to Muzdalifah on the 9th of Zil Hijjah. Tayan et al. (2014) proposed an analytical and simulation-based model using the DES platform OMNeT, selected for its powerful debugging tools, detailed graphics and ability to perform sophisticated data analysis. Using this framework, the authors developed bottleneck scenarios and presented solutions for traffic management by improving bus travel times and capacity utilisation, as well as reducing congestion levels. Again, the number of pilgrims and their composition and bus types (conventional or shuttle) were not specified.

A more recent study by Yaagoubi (2018) reiterated that crowd and transport management are causes of safety concerns for the Hajj authority. This study proposed a model framework that combined GIS and agent-based modelling (ABM) to simulate pilgrim movements for 66,000 pilgrims during Hajj. Two scenarios were developed: 1. Mina to Arafat on the 9th; and 2. Mina to Aljamarat Bridge on the 10th; and included all transport modes, but the results were presented only for walking. Also, the number of agents simulated is small compared to the total number of pilgrims at the Hajj, and the authors argued that simulating the total number of pilgrims would require Big Data and Parallel Computing technologies.

Felemban et al. (2019a) also highlighted that planning and predicting pilgrim movements, scheduling their movements and monitoring the ritual performances are necessary to guarantee successful Hajj management. They acknowledged the role played by the Mashaer railway project, which has substantially enhanced transport at Hajj. Trains operate at Hajj in five movements/patterns and different time windows, as follows:

- Movement A: Between Makkah and Mina from the 7th to the early night of the 8th, stopping at all intermediate stations.
- Movement B: Between Mina and Arafat from the 8th (8 pm) to the 9th (11 am), without stopping at any intermediate stations.
- Movement C: Between Arafat to Muzdalifah from the 9th (6:55 pm) to the 10th (00:30 am).
- Movement D: Between Muzdalifah to Mina on the 10th from 1 am to 9 am.
- Movement E: On the last three days (11th, 12th, and 13th) continuously from Mina to the Aljamarat Bridge station.

Note that there are no stations between Arafat and Muzdalifah, and between Muzdalifah and Mina. Using 2019 data, Felemban et al. (2019a) proposed a new schedule for the trains based on a shuttle operating pattern which included the dispatch date and time from Mina city and specified the gate at the departure station, in addition to the movement type (A, B, C, D or E), departure and arrival times, and platforms. They applied an algorithm built in MATLAB to mimic train movements in a loop. Their results showed a substantial increase in the number of pilgrims transported between Arafat and Muzdalifah using movement C, from 304,000 to 376,000 pilgrims (Felemban et al. 2019a). Felemban et al. (2019a) also pointed out that movement C was improved because each establishment followed their schedules and used their designated paths to the station, thus avoiding crowd build-up and preventing any incidents.

However, the study did not mention details of the operation, such as travel time or number of trains used.

In a related study, Felemban et al. (2019b) noted that crowds can cause frequent bus stoppages and road congestion during Hajj. The authors presented an interactive big data platform to visualise the movement of more than 20,000 buses during Hajj by using data from the GPS trackers. This platform provides routes, travel distances, and times for each bus and each TE, and assists users in identifying congestion on roads. However, no clear description was provided of how this data could be used to obtain solutions for avoiding or alleviating congestions. In addition, the solutions may differ depending on the potential users of this platform (e.g., Ministry of Hajj, GCS, or TEs), as the optimisation may reflect the different perspectives and objectives of each.

In summary, previous models and simulations for Hajj transport are insufficient and primarily address the Al-Nafrah movement. Furthermore, there are some limitations common to most models:

- Not all previous studies reported details on the year for which Hajj transport data was collected.
- With a few exceptions, previous research considered transport by bus only.
- Although the Al-Nafrah movement is critical for Hajj authorities, all pilgrim movements are important for the good organisation of Hajj and also require proper planning and transport management measures in place.
- The number of pilgrims simulated and their group membership was not specified.

The present paper reports on modules integrating all Hajj transport modes (buses, railways and walking), as well as all movements required during Hajj from the first (8th Zil Hijjah) to the third (10th Zil Hijjah) day of Hajj.

We use “ExtendSim” DES as a modelling and simulation tool for Hajj transport movements. DES has been used to model a wide range of systems as connected, sequential processes (Serova 2013). Examples include arrivals for a service, resource utilisation, batching/combining resources, waiting in queues, different types of activities (including transport), and exits. We present the results of a transport model including three modules for various movements, which represents a step towards the integration of various Hajj transport linking rituals at different holy sites in a single model, thus addressing the critical gap identified in the literature.

5.4. Data Sources

The lead author gathered secondary data from The Institute of Hajj and Umrah Research and Ministry of Hajj, images and video material of Hajj, and tables and figures of Hajj 2019 operational planning from Hajj transport Department and The Saudi Car Syndicate Operational planning. In addition, the validation process used data from daily reports and social media coverages of Hajj 2019, corroborated with personal experiences of other co-authors from their own Hajj. These data sources were compared and cross-checked before module inputs were set, and the simulation results were compared with published statistics of Hajj and media reports.

5.5. Modelling and simulation implementation

The module presented here is for the transport of pilgrims from The Grand Mosque to Mina (about 7 km to the East) on the 8th; from Mina and The Grand Mosque to Arafat on the 9th (20 km); and from Arafat to Muzdalifah (7 km) on the 9th. Mina consists of more than 100,000 tents for pilgrim accommodation and has a complex network of streets for vehicular movements (Al-Kodmany 2011; Al-Nabulsi 2015; Owaidah et al. 2019). Arafat Mountain, the most crowded site of Hajj, is an open site without transport infrastructure. Muzdalifah is a plain, level area on the route between Mina and Arafat.

The movement schedules between these sites are as follows (see Figure 5-3).

- On the 1st day of Hajj (the 8th) most pilgrims go to Mina to spend the night (Alkhadim et al. 2018).
- After the night of rest, on the 2nd day of Hajj (the 9th), pilgrims travel from Mina to arrive at Arafat (about 12 km) preferably before noon, but no later than sunset (Alkhadim et al. 2018).
- Pilgrims leave Arafat Mountain for Muzdalifah as soon as possible after sunset, either walking or travelling by dedicated public transport (Owaidah et al. 2019).

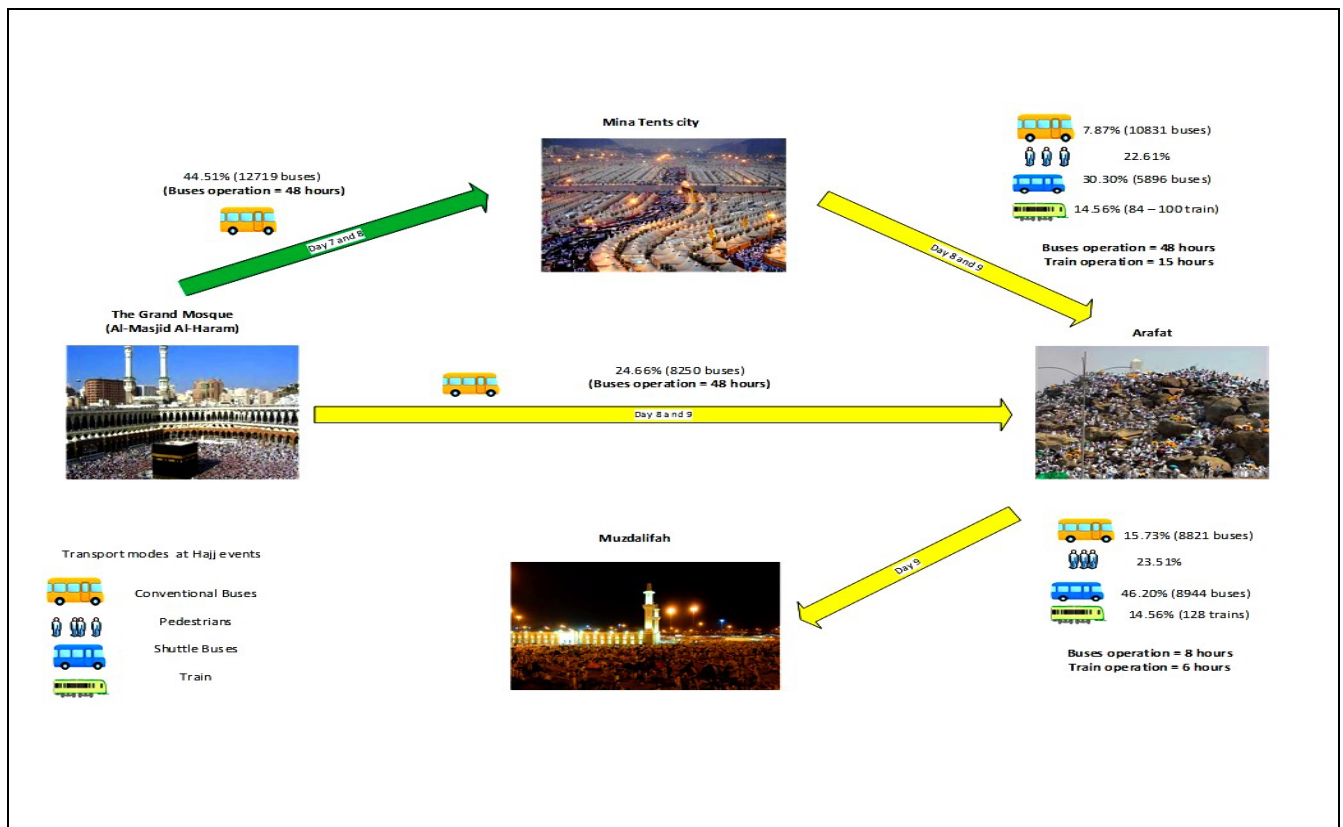

Figure 5-3: Transport operations at Hajj 2019

Note: The percentages represent the proportions of transported pilgrims by modes.

The allocation of pilgrim groups to transport modes was implemented by Hajj authorities (Hajj CORE 2010) to account for the fixed boundaries of the area, limited number of roads (Al-Sabban and Ramadan 2005) and mix of traffic (Seliaman et al. 2001; Hanrahan 2015), all of which result in congestion (Kaysi et al. 2013). Two-thirds of the bus fleet (more than 20,000 buses each with capacity 52 seated passengers) are shuttle buses that use dedicated routes, and the rest are conventional buses. Approximately 45% of the pilgrims are transported from Makkah to Mina using conventional buses. The train operates based on specific patterns between the nine stations of the sites (Kaysi et al. 2012; Kaysi et al. 2013) (see Figure 5-4) and at any given time, there are seventeen 12-car trains running (full capacity of 20 trains), serving 3,000 pilgrims (Makkah Region Development Authority 2019).

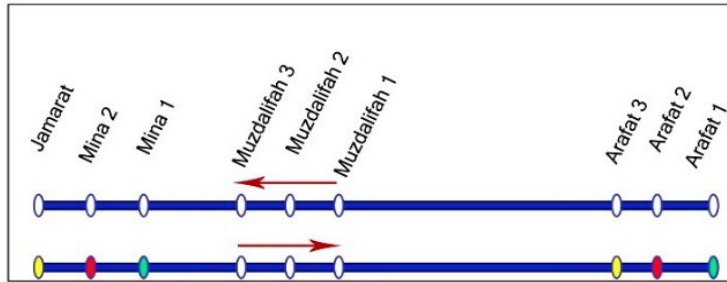

Figure 5-4: Mina-Arafat Movement patterns of Al-Mashaer Metro during Hajj (by permission from Kaysi et al. 2012, p.257)

Note: Trains do not stop at Muzdalifah Stations 1, 2, and 3. The colours indicate the matching boarding-alighting stations.

5.5.1. Hajj Transport Model in ExtendSim

The simulation model includes sets of hierarchical blocks, each performing a specific activity. Table 3-13 (Chapter 3), Table 4-1 (Chapter 4) and Table 5-14 (Appendix of this chapter) present the main blocks used in our modules and their functions. An Executive block (Figure 5-6A - Appendix) located at the top left corner of each module controls the simulation timing and passage of the pilgrims through the system.

The Create block (Figure 5-6B - Appendix) generates 3,000,000 pilgrims. These pilgrims have the following features incorporated in the module using Set and Get Attributes blocks (Figure 5-6C and D - Appendix).

- **Pilgrim group and region/TE:** percentages of the total pilgrims from Hajj 2019 and their region and TE.
- **Age:** Pilgrims were categorised into two groups: 40% aged between 10 and 50 years, and 60% aged 50 years+, each with different fitness levels.
- **Speed:** Pilgrim speeds vary between 0.88 to 1.46 m/s based on their fitness and level of fatigue (three levels are assumed: rested, tired, and very tired), as mentioned in Table 5-12 (Appendix). The average walking speed for the pilgrims aged 10–50 is 1.32 to 1.46 m/s, and for elderly pilgrims it is 1 to 1.2 m/s. Triangular distributions with values between 0.4 and 1.6 m/s were used to model walking speeds.
- **Fatigue:** The pilgrims' level of energy is assumed to decrease as they progress through Hajj, and accordingly, their walking speed decreases. From "rested" to "tired," the speed drops by a factor of

1.11 and from "rested" to "very tired" it declines by a factor of 1.25. These average levels were established based on the video material and tested during the sensitivity analysis.

- **Incident rates:** Major incidents occurred at Hajj between 2002–2015 (Bianchi 2017) involving predominantly eight countries. The incidence rates for groups more prone to accidents are found in Owaidah et al. (2021). They vary from 0.06% (Iran) to 0.53% (SA).

5.5.1.1. Transport from Makkah to Mina (module 1)

Transport module 1 (Figure 5-7 Appendix) includes the movement of pilgrims on the 8th from the Grand Mosque in Makkah to Tent City in Mina. Some pilgrims stay in Makkah and travel directly to Arafat the following day (simulated in transport module 2). The numbers of pilgrims moving between the sites are listed in Table 5-3 and details on the bus stops, distances from the Grand Mosque gates, and to Mina city are shown in Table 13 (Appendix) (note that pilgrim groups are mapped against bus stops accessible to them according to their location in Mina). The models assume as the unit of analysis the group of 250 pilgrims, led by a guide, and being part of one of the seven TEs.

Seven Transport blocks model the movement of the distinct TEs and their capacity is defined by the number of buses per hour. Based on the 2019 statistics, the module mimics the movement of approximately 1.2 million (1,175,279) pilgrims using 12,719 buses (Table 5-3) considering the number of routes available for each TE. Transport module 1 also includes seven each of Resource Pool, Batch, and Unbatch blocks (Figure 5-7A, B, C, and D respectively - Appendix) used to allocate 52 passengers to a bus (Batching) and disembark them at the destination (Unbatching). The Resource Pool blocks hold a total of 14,000 conventional buses, used to complete the transport task, and split by Hajj authorities among the seven TEs. Additionally, Shift blocks are used to generate schedules for the seven groups. Finally, Exit blocks (Figure 5-7E - Appendix) are used to pass all transported pilgrims through to the next stage of the simulation, while Plotter or Chart blocks (Figure 5-7F - Appendix) are used to visualise the performance of the module.

The following simplified Equation 1 (Figure 5-8– Appendix) was used in the transport block:

Travel Equation (time in min)	
<i>If(Incident==0)</i>	$Traveltime = \frac{1}{60} \left[\frac{(Access\ Distance + Egress\ Distance)}{(Speed / (ReduceSpeed \times Tired))} + ttime + wait + random \right]$
<i>Else</i>	$Traveltime = \frac{1}{60} \left[\frac{(Access\ Distance + Egress\ Distance)}{(Speed / (ReduceSpeed \times Tired))} + ttime + wait + random \right] + 10$

Equation 1

where:

- *ttime* represents the in-vehicle travel time for the transport mode (e.g., Conventional bus travel time from Makkah to Mina is about 20 min to 40 min, depending on the route);
- Access distance: distance from the camp to the bus stop where boarding;
- Egress distance: distance from bus stop (Mina, Muzdalifah) to Al-Rahmah Mountain at Arafat area;
- Speed: pilgrims speed (Table 12 - Appendix);
- ReduceSpeed and Tired: factors to reduce speed for elderly pilgrims and depending on the pilgrim fitness (fit, tired or very tired).

Table 5-3 also presents the numbers of pilgrims moving between the sites on the 9th (modules 2 and 3).

Table 5-3: Number of pilgrims transported by buses from site to site (Department of Transport, Ministry of Hajj, 2019)

Pilgrims Groups	Total pilgrims' numbers Hajj 2019	Transport Makkah to Mina (8 th)		Transport Mina to Arafat (9 th)		Transport Makkah to Arafat (9 th)		Transport by train Mina to Arafat (9 th)	Transport pedestrians (8 th and 9 th)	Transport Muzdalifah (9 th)		Transport by train Arafat to Muzdalifah (9 th)	Transport pedestrians Arafat to Muzdalifah (9 th)
		# pilgrims	# buses (Conventional) [No. of trips for each bus]	# pilgrims	# buses (Shuttle and Conventional C) [No. of trips for each bus]	# pilgrims	# buses (Conventional) [No. of trips for each bus]			# pilgrims	# buses (Shuttle and Conventional C) [No. of trips for each bus]		
South East Asia (SEA)		64,500	623 [2]	64,500	478 [3]	243,000	1,874 [3]	0	116,014	307,500	2,499 [3]	0	0
South Asia (SA)		598,158	5,773 [2]	430,615	4,680 [2]	15,283	150 [2]	167,543	0	430,615	4,680 [2]	167,543	131,297
(SA)	1,126,633												
Iranians		11,282	68 [3]	11,282	50 [5]	78,396	477 [3]	0	0	89,678	327 [6]	0	0
Africa	187,814	150,394	1,003 [3]	150,394	615 [5]	0	0	0	37,420	150,394	615 [5]	0	37,420
Arabs	414,750	162,682	3,377 [1]	162,682	3,377 C [1]	216,933	5,085 [1]	0	35,115	370,289	7,921 C [1]	0	44,461
TEAA	245,002	143,263	975 [3]	143,263	731 [4]	97,537	664 [3]	0	4,202	241,906	823 [6]	0	3,096
Arabic Gulf	31,884	0	0	0	0	0	0	31,884	0	0	0	31,884	0
Locals	634,379	45,000	900 [1]	45,000	900 C [1]	0	0	185,000	403,379	45,000	900 C [1]	185,000	404,378
Total pilgrim and buses numbers	2,640,462	1,175,279	12,719	1,007,736	6,554 4277 C	651,169	8,250	384,427	597,130	1,635,383	8,944 8,821 C	384,427	620,652

5.5.1.1. Transport from Makkah and Mina to Arafat (module 2)

The second module includes the movement of all (3 million) pilgrims from Mina and Makkah to Arafat on the 9th day. Given the large number of pilgrims to be transported, all four travel modes (conventional buses, shuttle buses, trains, and walking) are used. Each motorised transport mode was modelled using Transport, Batch/Unbatch, Resource Pool, and Shift blocks using the mode distribution provided by the Hajj transport authorities (Table 5-3).

The top part of module 2 (Figure 5-9A - Appendix) focuses on pilgrim movements from Mina to Arafat by shuttle buses, which undertake a minimum of three return trips between these sites and are used for only five TEs: SA, SEA, TEAA, Africa, and Iran. The Transport blocks model the movement of 30.3% of pilgrims by 5,896 shuttle buses (2019 data). The timetable for each group is designed in Shift blocks. The Equation blocks feed the Transport blocks with door-to-door travel times. Except for walking, all travel times are calculated similarly to Equation 1, including access and egress to and from the station, waiting time, and in-vehicle travel time.

Figure 5-9B (Appendix) illustrates the transport of Arab and local (7.87%) pilgrims from Mina to Arafat using conventional buses. A total of 4,277 buses are used, each undertaking up to two round trips (2019 data). Each pilgrim group has a separate timetable, which is set within the Shift blocks. The following set of blocks (Figure 5-9C - Appendix) is used to model the transport of 24.66% of pilgrims directly from Makkah to Arafat without passing through Mina, using 8,100 conventional buses. This mode was applied to all pilgrim groups that stayed in Makkah. Transport movements were based on the Shift block timetables.

Figure 5-9D (Appendix) illustrates the transport of pilgrims from Mina to Arafat by train using the three main railway stations at each site. The Transport block for the train is set to carry 3,000 pilgrims using 128 trains per hour. In 2019, 14.56% of the pilgrims used this mode. According to the Hajj planning, only local, Arabic Gulf, TEAA, and SA pilgrims are allocated this mode of transport, and each of these groups has its own timetable, which is stored in the Shift Blocks. (More details of the train operation between Mina and Arafat and Arafat to Muzdalifah are provided in Table 5-4A and B).

Table 5-4: Train operations between the holy sites

A. Train operations from Mina to Arafat					
Access distance and time from camps to stations (walking)	From	To	Train distance	Avg. trip time	Egress distance and time to Al-Rahmah Mountain
Avg. 1.8 km (25 min)	Mina 1	Arafat 1	11.2 km	11 min	2.4 km (30 min)

Avg. 1.2 km (19 min)	Mina 2	Arafat 2	11.3 km	15 min	2.1 km (26 min)
Avg. 2.6 km (29 min)	Mina 3	Arafat 3	13 km	15 min	3.2 km (45 min)
B. Train operations from Arafat to Muzdalifah (Muz)					
Access distance and time to Al-Rahmah Mountain) (walking)	From	To	Train distance	Avg. trip time	Egress distance and time to Muzdalifah area
Avg. 2.4 km (30 min)	Arafat 1	Muz 1	7.8 km	14 min	3.1 km (39 min)
Avg. 2.1 km (26 min)	Arafat 2	Muz 2	8.3 km	9 min	1.8 km (23 min)
Avg. 3.2 km (45 min)	Arafat 3	Muz 3	8.5 km	10 min	2.5 km (31 min)

Finally, Figure 5-9E (Appendix) shows the 22.61% of pilgrims who walk, using the pedestrian routes between Mina and Arafat, and the Transport activity block is used to simulate these. Equation 2 below gives an example calculation for the walking time, where ReduceSpeed and Tired are discrete factors reducing the walking speed under different conditions. It assumes that the walking time doubles in the case of an incident, wherein ReduceSpeed and Tired are discrete factors that reduce walking speed under various conditions.

Walking Equation (time in min)	
$\text{If } (Incident == 0) \text{ Walktime} = \frac{Distance \times \frac{1}{60}}{(Speed / (ReduceSpeed \times Tired))}$	
Else	
$\text{Walktime} = 2 \frac{Distance \times \frac{1}{60}}{(Speed / (ReduceSpeed \times Tired))}$	

Equation 2

5.5.1.2. Transport from Arafat to Muzdalifah (module 3)

Module 3 uses the same blocks and functions of module 2, but with different Shift blocks and different train timetable. The mode share is changed, with shuttle buses increasing to 46% (8,944 buses) and conventional buses to 16% (8,821 buses). On the other hand, the railway system is increased only slightly (0.5%) and the number of pilgrims walking is increased by 2%. All these detailed are found in Figure 5-5.

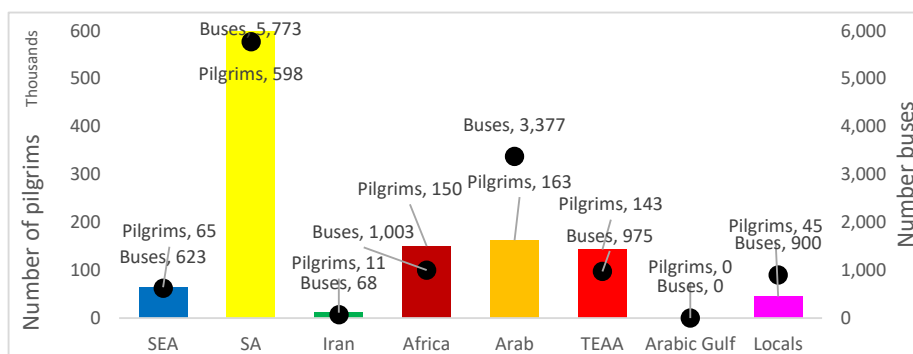

(a) Transported pilgrims (Makkah-Mina) on the 8th day and number of buses allocated

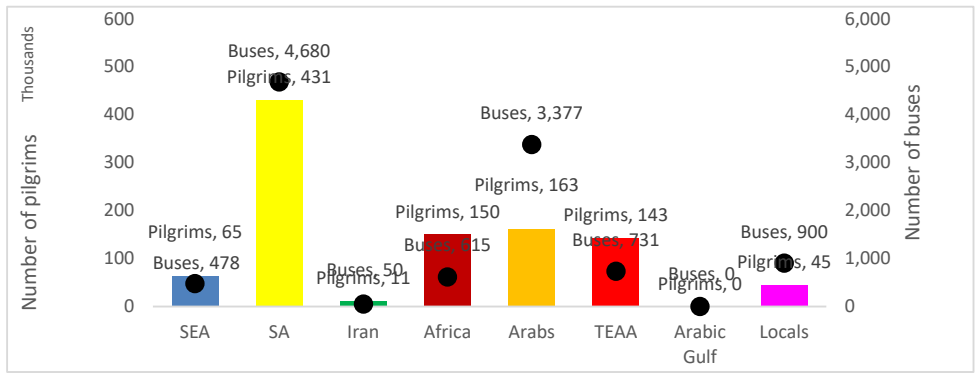

(b) Pilgrims transported by Conventional and Shuttle buses (Mina-Arafat) on the 9th day and number of buses allocated

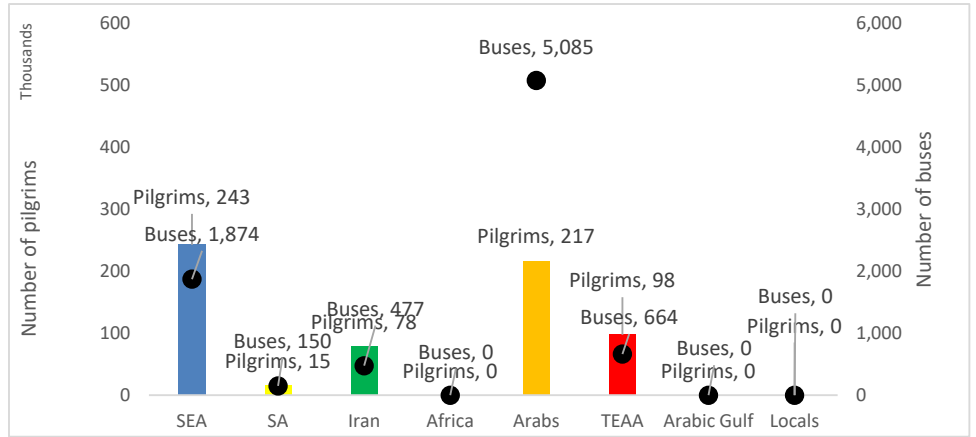

(c) Pilgrims transported by Conventional buses (Makkah-Arafat) on the 9th day and number of buses allocated

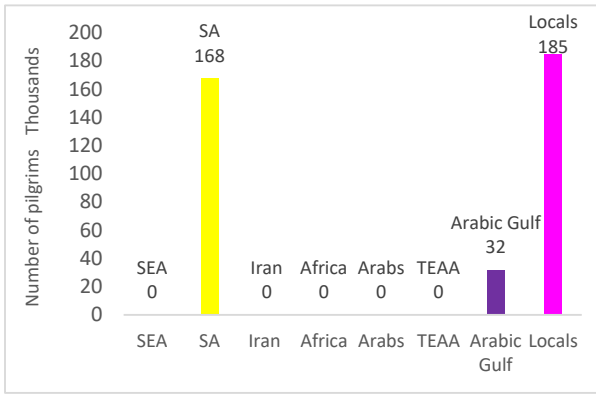

(d) Pilgrims transported by train (Mina-Arafat) on the 9th day

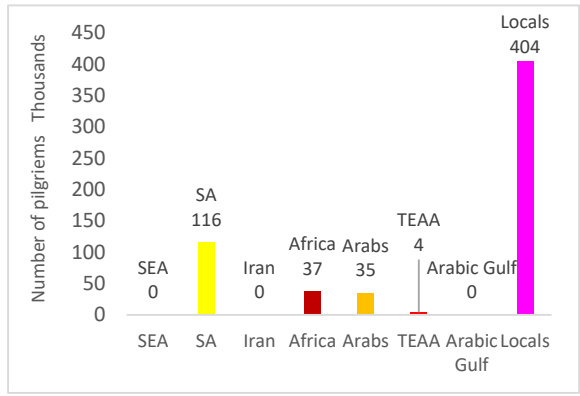

(e) Pilgrims walking (Mina-Arafat) on the 9th day

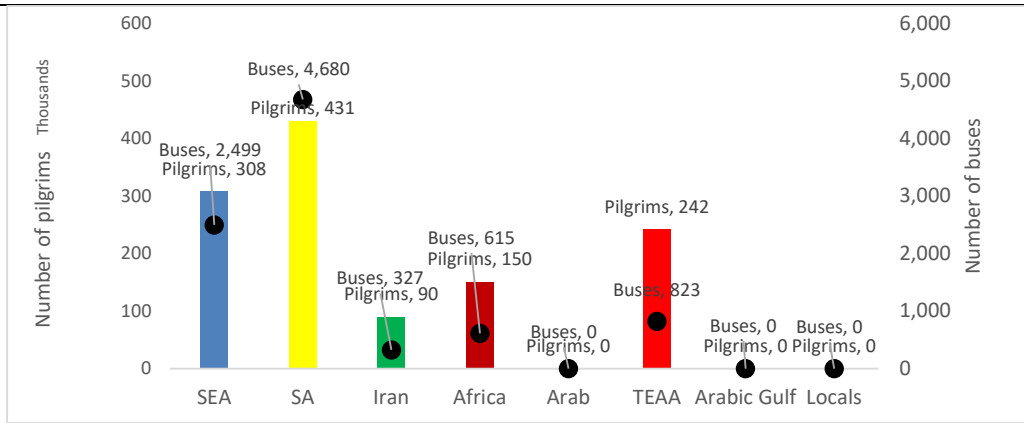

(f) Pilgrims transported by Shuttle buses (Arafat–Muzdalifah) on the 9th day and number of buses allocated

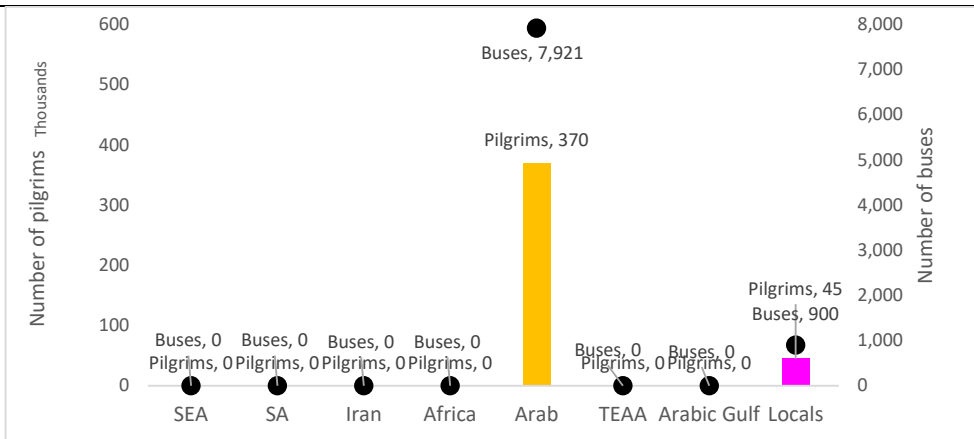

(g) Pilgrims transported by Conventional buses (Arafat–Muzdalifah) on the 9th day and number of buses allocated

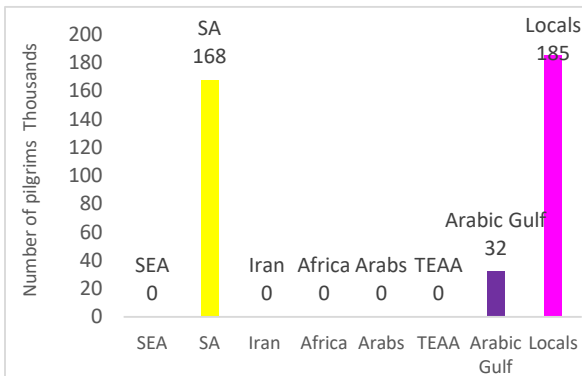

(h) Pilgrims transported by train (Arafat–Muzdalifah) on the 9th day

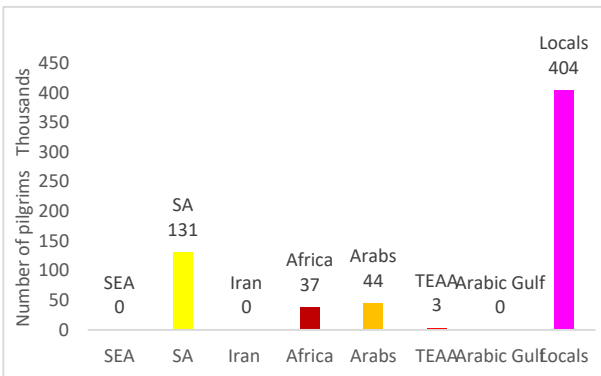

(i) Pilgrims walking (Arafat–Muzdalifah) on the 9th day

Figure 5-5: Pilgrims' numbers and movements between the holy sites on the 8th of Zil Hijjah from Makkah to Mina, and 9th from Makkah and Mina to Arafat and from Arafat to Muzdalifah (Department of Transport, Ministry of Hajj, 2019)

5.5.2. Model Validation

Transport modules 1, 2, and 3 were validated with 2019 Hajj data by comparing the averages of 30 runs for each module with the published statistics. Table 5-5 presents the results of module 1 from Makkah to Mina, such as the number of groups and the duration of transport for each group compared with the aggregated 2019 data. For ease of presentation, group numbers were considered instead of pilgrim numbers. Regarding transport durations, the simulation of the SEA and Locals groups showed the same durations as the real data (51 and 65 min, respectively), while the other groups recorded very similar times compared to their reported aggregate data (no statistically significant differences using t-tests).

Table 5-5: Validation of module 1 - from Makkah to Mina by Conventional buses on the 8th day

Mina to Arafat (Conventional and Shuttle buses)	TEAA	SEA	SA	Africa	Iran	Arabs	Locals
Number of groups*	573	260	2,430	602	45	652	180
Travel time (min) (sim results)	55	51	49	47	40	66	65
Travel time (min) (real data)	54	51	50	48	43	68	65

Note: The travel time for Locals and Arabs TE are the longest as they are allocated to the longest routes.

Travel times from Mina to Arafat are shown in Table 5-6 for simulated as well as real data. The simulation results compare well with the real data. For transport module 2, Table 5-6 as well illustrates the results of travel from Makkah to Arafat by conventional buses, and from Mina to Arafat by shuttles and conventional buses, train, and walking. Again, the times are similar, with no statistically significant differences from the reported statistics (t-tests). One exception is the train duration from Mina stations 1, 2, and 3 to Arafat stations 1, 2, and 3, which required an extra 3–4 min compared with the reported simulation results of 53, 54, and 53 min. These minor differences are expected, as the Hajj statistics are aggregated and not reported by establishments, and neither the details of locations in Mina city nor the details of the components of door-to-door travel times were considered.

Table 5-6: Validation of module 2 - from Makkah and Mina to Arafat by all transport modes on the 8th and 9th days

Makkah to Arafat (Conventional bus)	TEAA	SEA	SA	Africa	Iran	Arabs	Locals	Arabic Gulf
Number of groups*	390	972	61		314	868		
Travel time (min) (sim results)	58	58	68		59	59		
Travel time (min) (real data)	58	56	68		59	57		
Mina to Arafat (Conventional and Shuttle buses)	TEAA	SEA	SA	Africa	Iran	Arabs	Locals	Arabic Gulf
Number of groups*	573	258	1722	602	45	651	180	

Travel time (min) (sim results)	54	52	61	43	51	56	64	
Travel time (min) (real data)	55	53	60	44	52	57	67	
Mina to Arafat (Train)	Mina 1–Arafat 1			Mina 2–Arafat 2			Mina 3–Arafat 3	
Number of groups*	525			496			517	
Travel time (min) (sim results)	56			56			57	
Travel time (min) (real data)	53			54			53	
Mina to Arafat (Walking)	TEAA	SEA	SA	Africa	Iran	Arabs	Locals	Arabic Gulf
Number of groups*	17		464	150		140	1,618	
Travel time (min) (sim results)	150		145	146		145	145	
Travel time (min) (real data)	150		150	150		150	150	

Note: * Each group has 250 pilgrims.

Table 5-7 presents the results of the validated transport module 3 for the travel from Arafat to Muzdalifah (Al-Nafrah movement) by all modes, again matching the actual times reported in 2019. The differences are minor: Iranian, African, and Arabs groups required 2 minutes less compared to reported statistics, whereas SA and Locals were transported in 3–4 min lesser than the reported statistics; transport by train 3 required 1–2 min more than the reported Hajj averages.

Table 5-7: Validation of module 3 – from Arafat to Muzdalifah (Al-Nafrah movement) by all transport modes on the 9th day

Arafat to Muzdalifah (Conventional and Shuttle buses)	TEAA	SEA	SA	Africa	Iran	Arabs	Locals	Arabic Gulf
Number of groups*	968	1,230	1,722	602	359	1,481	180	
Travel time (min) (sim results)	49	42	44	47	45	53	41	
Travel time (min) (real data)	49	42	47	49	47	55	45	
Arafat to Muzdalifah (Train)**	Arafat 1–Muzdalifah 1			Arafat 2–Muzdalifah 2			Arafat 3–Muzdalifah 3	
Number of groups*	529			467			542	
Travel time (min) (sim results)	50			51			52	
Travel time (min) (real data)	51			53			54	
Arafat to Muzdalifah (Walking)	TEAA	SEA	SA	Africa	Iran	Arabs	Locals	Arabic Gulf
Number of groups*	12		525	150		178	1,618	
Travel time (min) (sim results)	119		115	116		115	115	
Travel time (min) (real data)	120		120	120		120	120	

Note: * Each group has 250 pilgrims.

These results provide support to the credibility of the models (as they closely reflect the real situation as reported in Hajj averages) and consequently for the results of the explored scenarios in Section 6. The differences across TEs also highlight different utilisations of the fleets and reserves of capacity.

5.6. Hajj scenarios

Transport scenarios were developed to test the system capabilities and understand how to optimally use the resources (achieve judicious allocation of buses and trains). More than 55 "what-if" scenarios were tested by changing the allocated pilgrim percentages for each group and their time windows to identify the point at which

the fleet was "under stress". Table 5-8 lists the types and categories of transport scenarios (setups) and modules tested. The objective was to: 1) reallocate the TEs to the four modes (change the mode share) to achieve a more consistent utilisation of the current fleets of buses and trains, while reducing the number of groups walking; 2) to test the impact of scheduling, by re-ordering the transport of some of the TEs and compressing the timeline. Importantly, all these scenarios assume the current fleets, without any further investments. They also assume the same number of passengers/bus or train, thus not deteriorating the level of service by crowding the public transport.

Table 5-8: Selection of developed transport scenarios

Module tested	Scenario type	Scenario categories	Description/Conditions	
TM1	Scenarios related to changes in pilgrim percentages: Increasing or decreasing the pilgrim group numbers (change percentage) allocated to different transport modes. For example, changing SEA from 20% using conventional buses and 80% using shuttles to 30% using conventional buses, 50% shuttles, and 20% walking (refer to sections 5.5.1.1 and 5.5.1.2 for transport modes details).	100% Makkah to Mina	All pilgrims are travelling from Makkah to Mina on the 8th day by Conventional buses (currently 44.51% of total pilgrims). No change in the bus allocation or scheduling.	
TM1		Balanced allocation 1	Balancing the pilgrim group allocation by increasing the percentage for smaller groups and reducing it for large groups (three levels applied, 10, 20, and 30%). No change in the bus allocation.	
TM1		Balanced allocation 2		
TM1		Balanced allocation 3		
TM1		Scenarios related to changes in transport timetables	Equal mode share 50%	Setting the same percentages of pilgrims to use a certain transport mode (50, 60, and 70%). No change in the bus allocation.
TM1			Equal mode share 60%	
TM1			Equal mode share 70%	
TM2 and TM3			New mode share 1	<ul style="list-style-type: none"> Increasing or decreasing percentages to accommodate all transport modes. TEAA is eligible to ride the train. In transport module 3, primarily testing walking for increasing percentages of pilgrims. No change in the bus allocation.
TM2 and TM3			New mode share 2	
TM2 and TM3			New mode share 3	
TM1 and TM2	Scenarios related to changes in transport timetables		Compressed time window 1	<p>Given the relatively low utilisation of buses and trains, we tested the possibility of reducing the total time window for transport from 48 h to 36, 32 and even 24 h, to assess whether pilgrims would have more time to rest at Mina and can be transported to Arafat earlier, to reduce congestion at the site. Each timetable was organised in three separate ways and simulated within the reduced time window (original data and validated modules in 48 h):</p> <ul style="list-style-type: none"> 36 h 1: staggered, group by group. 36 h 2: grouping large and small groups and scheduling transport in two time periods. 36 h 3: all groups start moving at the same time (simultaneously). No change in the bus allocation.
TM1 and TM2		Compressed time window 2		
TM1 and TM2		Compressed time window 3 – congested		
TM1	Rearranging bus allocation	100% Makkah to Mina - reallocation of buses	Pilgrims travelling from Makkah to Mina on the 8th by Conventional buses, while reallocating the bus numbers to each TE, but without changing the fleet size.	
TM2		Makkah to Arafat for SA New mode share 2 and 3	Changing the bus allocations for Conventional bus mode.	
TM3		Arafat to Muzdalifah for Locals New mode share 3	Changing the bus allocations for Conventional bus mode.	

Note 1: Not all groups were eligible to use the train (SEA, Africa, Iran, and Arabs).

Note 2: This set of combinations of percentages cover the most probable alternatives that can be accepted by Hajj authorities but does not cover all possible combinations. For TMs 2 and 3, the Hajj authorities may limit access to buses.

5.7. Results of Scenarios

To avoid developing modules for unrealistic situations that are unlikely to occur during Hajj, some factors were kept unchanged. For example, we maintained the allocation of buses per TE, the routes, and the validated transport durations, focusing on the identified reserves of capacity. A similar regime was maintained for testing the 36, 32 and 24 hours (compressed time windows) scenarios developed for TM1 and TM2 (for buses), and for assessing to what extent the current 48 hour time window for pilgrims to be transported from Makkah to Mina, then from Makkah and Mina to Arafat could be compressed. However, these scenarios are not applicable for TM3, modelling the Al-Nafrah movement from Arafat to Muzdalifah, which is limited to six to eight hours starting from the sunset of the 9th day until 2 am of the 10th.

The first scenario of “100%” of pilgrims transported was tested only for TM1, to observe the efficiency of using the current fleet for the transport of each group without increasing the number of buses or road capacity. However, this scenario is not relevant to TM2 and TM3 because, in these modules, all pilgrims must use all transport modes from Mina to Arafat and then to Muzdalifah, as planned by the Hajj authorities. The TM1 "Balanced allocation" and "Equal mode share" scenarios were conducted by changing the allocated percentage of transported pilgrims from one site to another. "New mode share" scenarios involved changing the percentage for all transport modes in TM2 and TM3.

The summary of the results is provided in Table 9 and Table 10 using the traffic-light model to indicate where problems may appear⁶.

5.7.1. TM 1 - Makkah to Mina

All scenario results were compared with the validated modules.

First, the "Balanced allocation" scenarios (Table 5-8) show limits of the fleet, beyond which TEs fail to satisfy the transport demand. For example, the SA transported all its groups, as they benefitted from a large number of buses (almost 5,800, see Figure 5-5A) and a substantial capacity reserve. Similarly, Africa (currently moving 80% of their pilgrims by bus) and TEAA (58% of them transported from Makkah to Mina) satisfactorily carried their groups and missed only one to two groups. However, the SEA (only 21%

⁶ The scenarios results are available and stored on UWA cloudstor website:
<https://cloudstor.aarnet.edu.au/plus/s/k0CJJTzBRTYb0MJ>

of them transported from Makkah to Mina in 2019, as per validated model) struggled when larger numbers were assumed to travel on the 8th, given their allocation of 623 buses. SEA could not transport five groups for 30%, seven for 40%, and 13 for 50% allocations. The Iranian TE effectively transported all of its groups at 10% and 30% allocations. However, when 50% of their numbers were assumed to travel from Makkah to Mina, the small current fleet of 68 buses was insufficient to carry all groups (28 groups were not transported in the time period). Arabs and Locals struggled excessively in this scenario, because of their current high utilisation of the allocated fleet (about 3,400 for Arabs and 900 for Locals, see Figure 5-5A). For the Arabs (validated for 39% of the pilgrims to travel from Makkah to Mina), when the percentage increased to above 50% and up to 70%, the allocated fleet could not complete the transport of 32 (up to 51) groups. A similar situation was encountered by the TE Locals (7% in the validated module), where the number of buses could not transport 10 to 60 groups within the set time window when their percentage increased from 10% to 30%.

Regarding transport durations, there were no statistically significant differences between the validated and scenario average times for the Arabs, SEA, Locals, SA, Africa, and TEAA. For the Iranian, the first scenario resulted in a similar value to their validated duration; however, when the percentage increased to 30%, the average duration increased by 16 min, and when it reached 50%, an additional 50 min was required on average to complete the transport task.

Second, in the “Equal mode share” scenarios (50%, 60%, and 70%), a few TEs managed the tasks within the constraints with good results. For example, SA showed excellent results; however, SEA faced difficulties at these percentages and missed transporting 9–15 groups. Again, both Africa and TEAA missed to transport only two groups of them. Most difficulties were encountered by the Iranian and local groups, who could not complete the transport for 99–172 and 75–111 groups, respectively. This was owing to the small number of buses that were originally allocated to these groups (see Figure 5-5A).

With regard to travel time, most groups (e.g., Arabs, SA, SEA, Africa, and TEAA) recorded average durations similar to the validated results and comparable to the 2019 Hajj, whereas Locals required an extra 2–5 min. Conversely, the Iranian group utilised 89 min for all scenarios, and yet it did not fully simulate all of its groups.

The worst-case scenario involved transporting “100%” of all the groups with the currently allocated fleet of buses. Unsurprisingly, SA (originally 58% transported from Makkah to Mina) was the only TE

that managed carrying all of its groups, a reflection of the substantial allocation of the fleet to this group. The African (80%) and TEAA (58%) also showed good results, with only three or six fewer groups not being transported within the time window. However, SEA and Arabs could not transport all their groups and missed 36 and 64 groups, respectively. This may be explained by the longer door-to-door travel times (15-20 longer than most groups). Finally, as expected, the Iran and Locals TEs encountered difficulties in their transport task and could not transport 279 and 393 groups, respectively, within the time window.

For transport durations, the TEAA, SA, and Africa required an average of 2–3 min extra for transport, whereas SEA, Iran, and Locals required 22, 90, and 75 more minutes, respectively, to transport their groups.

From the above scenarios of TM1, the SA can transport up to 100%, SEA up to 40% (with extra buses), Iran up to 30%, Africa and TEAA up to 100% (with extra buses), and Arabs and Locals up to their validated percentages of 39% and 7%, respectively. With adequate bus fleet allocation, the transport task was satisfied for all groups.

The “Compressed time window” scenarios (36, 32, and 24 h)⁷ required shifting the group timetables such that they fit into the compressed timeline. Compared with the allocated percentages (balanced and equal), these scenarios showed promising results for all groups (except for the Locals) in simulating transported groups and transport durations. However, even the group of Locals presented better results (demand for 10–12 groups unmet, compared to 11–393 groups in the previous scenarios).

Similar results were recorded for the average travel time of all groups, apart from the Iranian and Locals (which required an average of 2–7 min and 2–4 min extra, respectively); all the other groups had similar average travel times. This suggests that distinct timetabling can enable the current fleet to satisfy the transport task by tapping into the current capacity reserves.

5.7.2. TM 2 - Makkah and Mina to Arafat

The scenarios of TM2 were developed based on the “Compressed time window” scenarios (36, 32, and 24 h) and the “New mode share” scenarios by distributing all pilgrims between all transport modes (conventional and shuttle buses, train, and walking), as presented in Table 5-10. However, the new mode

⁷ All transport timetables of Conventional and Shuttle buses for Hajj 2019 and the Compressed time window scenarios of all modules are available and stored on UWA cloudstor website: <https://cloudstor.aarnet.edu.au/plus/s/rSFJ129A7KkMZPJ>

share scenarios accounted for the specific transport modes set by Hajj authorities. For example, the African group had not been transported from Makkah to Arafat, and the Arabic Gulf group was not assigned to the conventional and shuttle bus modes. Additionally, the Iranian, Africa, SEA, and Arabs were not eligible to use the train. However, the TEAA was eligible to use the train, but did not use it during the 2019 Hajj. Therefore, TEAA was added to the train scenarios.

5.7.2.1.TM2 - Makkah to Arafat by Conventional buses

The “new mode share” scenarios were also applied to transport pilgrims from Makkah to Arafat (not passing through Mina) as follows: SA (5%, 10%, and 15%), SEA (20%, 30%, and 50%), Iran (60%, 70%, and 100%), TEAA (20%, 30%, and 50%), and Arabs (30%, 30%, and 40%). These scenarios showed good results by transporting most of the pilgrim groups. Although Iran, TEAA, Arabs, and SEA recorded similar average travel times (no significant difference from the validated module), thereby confirming that the number of vehicles allocated was sufficient, the SA required substantially more time (13 more minutes in the second scenario and 101 minutes in the third scenario). This is because this TE was allocated only 150 buses for transport (see Figure 5-5C).

The “Compressed time window” scenarios (36, 32, and 24 h) were also developed for this mode to test the ability of current transport facilities to handle each group's transport operations. In the transport from Makkah to Arafat, only the SA completed the task within a short time interval. Additionally, the small groups of Iranians, SEA, TEAA, and Arabs could be accommodated, with only a few groups not fitting the schedule (Iran 1–5 groups, SEA 7–12 groups, TEAA 8–12 groups, and Arabs 9–13 groups). As a result, all durations were within 1–2 minutes of the validated average travel times.

5.7.2.2.TM2 - Mina to Arafat by Conventional and Shuttle buses

“New mode share” scenarios were again used in TM2, from Mina to Arafat via shuttle and conventional buses. The allocations were: SA (40%, 50%, and 60%), SEA (25%, 35%, and 45%), Iran (20%, 30%, and 40%), Africa (40%, 50%, and 60%), TEAA (30%, 40%, and 50%), Arabs (30%, 50%, and 70%), and Locals (40%, 50%, and 60%). All the groups completed the transport task. Also, these scenarios required less time than the validated duration of each TE because the tested percentages of most of these groups were lower than the validated percentages. For example, SA required 13–17 min less, while Africa, TEAA,

and Arabs required 6–7 min less, and finally the Locals required 7–9 min less. However, the SEA and Iranian required an extra 1–5 mins to transport their pilgrims.

For the second category of scenarios (the “compressed time window”) SA, Iran, Africa, TEAA, Arab, and Locals transported nearly all their groups, whereas the SEA transported all of them. Compared with the allocated percentages in “new mode share” scenarios, travel times for most of the groups in the reduced-time scenarios were lower by a couple of minutes, suggesting that judicious timetabling for the current module split can benefit the Hajj, by reducing the overall transport duration of the pilgrims.

5.7.2.3.TM2 - Mina to Arafat by Train and Walking

Three “New mode share” scenarios that were developed for the train and walking modes aimed to test the extent to which these modes can help in completing the transport of groups assigned to buses in their movements from Mina to Arafat and Makkah to Arafat. Developing scenarios that require changing transport timetables (“compressed time window”) are not applicable to train scenarios because the train is already constrained to operate within a specific time window of 15 h (which is much lower than the time windows of 36, 32, and 24 h).

In the “New mode share” scenarios, all groups were mixed and the TEAA was added to the groups of Arabic Gulf, SA, and Locals, to be transported via trains. Unlike the bus scenarios, wherein the results were reported individually per TE group, the results of the scenarios for train were calculated for the aggregated group (see Table 5-10).

In the first “new mode share” scenario (which presented the best results), the allocated percentages were SA 10%, TEAA 10%, Locals 30%, and the Arabic Gulf 60%. Only two groups were not simulated/transported under this scenario. This means that only one extra train is needed to complete the transport of all groups (extra cars cannot be added to the trains due to platform sizes). In the second “new mode share” scenario, SA and TEAA maintained the same 10% allocation, while that of Locals was set at 20% and of Arabic Gulf at 50%. As expected, in this scenario, all groups completed their travel within the time window. However, in the third “new mode share” scenario, wherein the percentages for SA and TEAA increased to 20% and 30%, respectively, while those for Locals (10%) and Arabic Gulf (40%) diminished, 11 groups were not transported.

The duration of transport for all groups increased with the addition of TEAA. For example, Scenario 1

required an additional interval of 4–5 min, Scenario 2 required 5–6 min, and Scenario 3 required 5–8 min.

Walking scenarios also showed good results in all three allocated scenarios because all groups were able to walk from Mina to Arafat (12 km) in 150 min (2.5 h) without any delays. The scenarios assumed no major incidents or inclement weather conditions. Currently, there are no infrastructure limitations for the pedestrian routes.

5.7.3. TM3 - Arafat to Muzdalifah (Al-Nafrah Movement)

The scenarios of TM3 were developed based on “new mode share” scenarios, by distributing the pilgrims among all transport modes (conventional, shuttle, train, and walking) in their movement from Arafat to Muzdalifah, as presented in Table 10. As indicated, timetables (as per the “compressed time window” scenarios) cannot be changed owing to the time constraints imposed on the Al-Nafrah movement after the sunset of the 9th day. The results of the “new mode share” scenarios show that the transport tasks by conventional and shuttle buses were completed for all groups. In these scenarios, the percentages were as follows: SA, SEA, and Africa (40%, 50%, and 60%); Iran (30%, 50%, and 70%); and TEAA and Arabs (30%, 40%, and 50%). Moreover, except for Locals, all durations were shorter than the validated average times, explained by the larger fleets allocated to this movement (almost 18,000 buses evenly split between conventional and shuttle buses). The travel times for SA groups were shorter by 3–10 min than their validated duration, SEA by 8–10 min, Iran by 8–13 min, Africa by 3–5 min, TEAA by 7–8 min, and Arabs by 11–12 min. However, the Locals required an extra 2–11 min on average for transport from Arafat to Muzdalifah.

Similar to TM2, three “new mode share” were also developed for train, to carry the SA, TEAA, Locals, and the Arabic Gulf TEs. In the first “new mode share” scenario, the percentages were SA 20%, TEAA 30%, Locals 30%, and the Arabic Gulf 60%. Only four groups were not transported in this scenario, which required an extra train to complete the transport. The allocations in “new mode share” scenarios 2 and 3 were SA 30% and 40%, TEAA and Locals 40% and 50%, and Arabic Gulf 50% and 60%, respectively. In both scenarios, one or two extra trains were required to complete the transport. The average duration of transport increased in all train scenarios, with scenario 1 requiring an average of 3 min to complete the transport of pilgrims, whereas scenarios 2 and 3 required 5–10 min. This suggests that Scenario 1 presents suitable percentages for train transport, without operational changes.

Finally, the “new mode share” scenarios for walking showed promising results for all allocated groups, as they were able to walk from Arafat to Muzdalifah (7 km) within 120 min (2 h) without any delays.

5.7.4. Buses rearrangement for transport models

The delays in transporting the Iranian group or the inability to complete the transport task for Arabs and Locals in TM1 suggest that fleet allocation requires adjustment. To overcome this problem, a new split of the bus fleet was proposed by rearranging the buses assigned to each group without increasing the total number of buses. The allocation was done proportional to the number of pilgrims, which means that larger TEs were allocated more buses, and the fleet allocation for small groups decreased accordingly. The final allocation⁸ was as follows: SA fleet decreased from 5,773 to 3,557, and that of Arabs decreased from 3,377 to 2,022; conversely, the fleet allocation for SEA increased from 623 to 1,499, Iran from 68 to 438, TEAA from 975 to 1,195, and Locals from 900 to 3,094; the smallest adjustment was for Africa TE, from 1,003 to 915. This new arrangement resulted in a significant improvement in bus operations from Makkah to Mina. For instance, for the Iranian group, the transport duration decreased from the validated 40 min (Table 5) to 35 min (10% allocation), 36 min (30%), 37 min (50%), and 38 min (60% to 70%) and only increased by 2 min for 100%. Similar results were obtained in the “100%” scenarios Makkah to Mina, for almost all groups, with the transport duration of SA, Arabs and TEAA were the same as their validated transport durations (49, 66 and 55 mins). However, SEA and Africa required an extra one minute compared to their validated transport durations, while the transport of Locals required 5 min, which indicated that this group still required extra time for their scheduling to fully transport their pilgrims (Table 5-5).

Hajj 2019 bus allocation also caused difficulties in transport from Makkah to Arafat (TM2). Particularly, the SA (in the “new mode share” scenarios) was unable to complete the transport of their pilgrims within the time window because of the small number of buses originally allocated by the Hajj authorities (150, see Figure 5-5C). By dynamically reallocating the number of buses for each group (without changing the total number of buses), the transport was improved for all TE groups. For the transport from Makkah to Arafat, the proportional allocation resulted in SA increasing their access to 1,268 buses in new share mode 2 (instead of 150, initially allocated for only 2% of the TE). In addition, in the

⁸ The scenarios results are with the new bus numbers are available and stored on UWA cloudstor website: <https://cloudstor.aarnet.edu.au/plus/s/hwfpvsdKGQ8Xe2j>

new mode share 2, TEAA allocated with 2,128, SEA 1,602, Iran 1,090 and Arabs 2,162 (instead of 664, 1,874, 477 and 5,085 respectively – see Figure 5-5C). In new mode share 3, SA allocated with 1,969, SEA 1,106, Iran 1,614, Arabs 2,239 and TEAA 1,322 buses. Specifically, with the SA group, the transport durations were reduced from 81 to 54 min and 169 to 54 min in the scenarios of “new mode share 2” and “new mode share 3” respectively, and less than their validated transport duration (68 min – see Table 5-6). This result indicates that the process of flexibly re-assigning buses based on the number of pilgrims in each group (as opposed to fixed allocation) is likely to reduce the transport duration without further increasing the fleet or altering the level of service (crowding of the buses).

The same conclusion was drawn for TM3, wherein the only group that had a mismatched allocation of bus services to the transport demand was Locals. Re-distributing the buses and allocating 1,625 buses to the Locals (the original number of buses 900 – see Figure 5-5G), reduced the transport duration by 11 min. This indicates that the transport duration and bus utilisation can be improved by allocating buses based on the number of pilgrims.

In summary, we developed a method to improve the use of current modes of transport. Two types of scenarios were tested: 1) changing percentages of each TE group per transport mode or altering the mode in which they are using the current capacity allocated to them; and 2) reducing the time window and identifying groups that can tolerate compressed timetables (36, 32, and 24 hours) for transport between the four main sites (Makkah, Mina, Muzdalifah, and Arafat).

Table 5-9 and Table 5-10 summarise all groups and their allocated percentages in each scenario, and the suitable distribution that can ensure good utilisation of transport capacity.

Table 5-9: Allocated scenarios’ results of TM1

Scenarios \ Groups	Balanced allocation 1	Balanced allocation 2	Balanced allocation 3	Equal mode share 50%	Equal mode share 60%	Equal mode share 70%	100%
South-East Asia (SEA)	30%	40%	50%	50%	60%	70%	100%
South Asia (SA)	40%	30%	20%	50%	60%	70%	100%
Iran	10%	30%	50%	50%	60%	70%	100%
Africa	20%	30%	50%	50%	60%	70%	100%
TEAA	10%	20%	30%	50%	60%	70%	100%
Arabs	60%	50%	70%	50%	60%	70%	100%
Locals	10%	20%	30%	50%	60%	70%	100%

Good results
Requires more buses
Requires more buses and extra time

These scenarios considered a fixed supply of services and examined a more judicious use of existing resources; hence, the number of buses, road capacity, and train frequency were kept unchanged. Also, no changes to LoS were made, considering the current level of service (52 passengers/bus and 3,000 passengers/train). From the train scenarios, the main finding is that adding a group of TEAA pilgrims would not pose any challenges to the train capacity (one or two extra trains would be required). Also, if the Hajj authority approves extra time for transport by train, this mode would accommodate even more pilgrims. The results show that for TM2, the allocation for SA and TEAA can be increased by up to 10%, for Locals by 30%, and for Arabic Gulf by up to 60%. For TM3, the maximum allocation of SA without substantially changing travel times is 20%, for TEAA and Locals it is up to 30%, and for the Arabic Gulf it is 60%.

Table 5-11 explains the current transport operations of each group and highlights situations when the capacity was inadequate. Additionally, suggested solutions are provided for each group/scenario based on the current facilities (Hajj Transport Data 2019). These solutions could be considered as alternatives for further exploration and adoption in transport operations by Hajj authorities. However, these authorities make the final decision for transport, based on their plans for the accepted number of TE groups, fleets and routes, developed annually.

Table 5-10: Allocated scenarios' results of TMs 2 and 3 (% allocation ONLY buses) *

TE	TM2 "New mode share" scenarios	Mina - Arafat (Con and Shuttle)	Makkah to Arafat	Train	Walking	TM3 "New mode share" scenarios	Arafat - Muz (Shuttle)	Arafat - Muz (Con)	Train	Walking
South-East Asia (SEA)	Scenario 1	25%	50%		25%	Scenario 1	60%			40%
	Scenario 2	35%	30%	0%	35%	Scenario 2	40%	0%	0%	60%
	Scenario 3	45%	20%		35%	Scenario 3	50%			50%
South Asia (SA)	Scenario 1	40%	5%	10%	45%	Scenario 1	40%		20%	40%
	Scenario 2	50%	10%	10%	30%	Scenario 2	50%	0%	30%	20%
	Scenario 3	60%	15%	20%	5%	Scenario 3	60%		40%	0%
Iran	Scenario 1	20%	60%		20%	Scenario 1	30%			70%
	Scenario 2	30%	70%	0%	0%	Scenario 2	50%	0%	0%	50%
	Scenario 3	0%	100%		0%	Scenario 3	70%			30%
Africa	Scenario 1	60%			40%	Scenario 1	60%			40%
	Scenario 2	40%	0%	0%	60%	Scenario 2	40%	0%	0%	60%
	Scenario 3	50%			50%	Scenario 3	50%			50%
Arabs	Scenario 1	30%	40%		30%	Scenario 1		50%		50%
	Scenario 2	50%	30%	0%	20%	Scenario 2	0%	40%	0%	60%
	Scenario 3	70%	30%		0%	Scenario 3		30%		70%
TEAA	Scenario 1	50%	20%	10%	20%	Scenario 1	50%		30%	20%
	Scenario 2	40%	50%	10%	0%	Scenario 2	40%	0%	40%	20%
	Scenario 3	30%	30%	30%	10%	Scenario 3	30%		50%	20%
Locals	Scenario 1	40%		30%	30%	Scenario 1		5%	30%	65%
	Scenario 2	50%	0%	20%	30%	Scenario 2	0%	10%	40%	50%
	Scenario 3	60%		10%	30%	Scenario 3		15%	50%	35%
Arabic Gulf	Scenario 1			60%	40%	Scenario 1			60%	40%
	Scenario 2	0%	0%	40%	60%	Scenario 2	0%	0%	40%	60%
	Scenario 3			50%	50%	Scenario 3			50%	50%



Good results
 Requires more buses
 Requires more buses and extra time

* Note: Groups' percentages in each scenario are complementary at all transported modes to be 100%

Table 5-11: Suggested transport solutions (from Tables 5-9 and Table 5-10)

Model	TE	Transport management from Real data in the validated module			Suggested transport solutions
		Current % in the module	No. of buses	Total scheduled transport duration in the module (h)	
TM1 Makkah to Mina	SEA	21	623	8	<ul style="list-style-type: none"> • Increase number of buses and routes • Increase scheduled time • Allocate up to 50% to be transported from Makkah to Arafat on the 9th day (Conventional mode) • Allocate up to 35% to be transported from Mina to Arafat on the 9th day (Shuttle mode)
	Iran	13	68	4	<ul style="list-style-type: none"> • Increase number of buses and routes • Increase scheduled time • Allocate up to 100% to be transported from Makkah to Arafat on the 9th day (Conventional mode) • Allocate up to 30% to be transported from Mina to Arafat on the 9th day (Shuttle mode)
	Africa	80	1,003	15	<ul style="list-style-type: none"> • Increase number of buses and scheduled time
	TEAA	58	975	16	<ul style="list-style-type: none"> • Increase number of buses and scheduled time • Allocate up to 50% to be transported from Makkah to Arafat on the 9th day (Conventional mode) • Allocate up to 50% to be transported from Mina to Arafat on the 9th day (Shuttle mode)
	Arabs	39	3,377	6	<ul style="list-style-type: none"> • Increase number of routes • Increase scheduled time • Allocate up to 40% to be transported from Makkah to Arafat on the 9th day (Conventional mode) • Allocate up to 70% to be transported from Mina to Arafat on the 9th day (Conventional mode)
	Locals	7	900	5	<ul style="list-style-type: none"> • Increase number of buses and scheduled time • Allocate up to 60% to be transported from Mina to Arafat on the 9th day (Conventional mode) • Allocate up to 30% to be transported from Mina to Arafat by Train
TM2 Mina to Arafat	SEA	21	478	3	<ul style="list-style-type: none"> • Increase number of buses and scheduled time • Allocate up to 50% to be transported from Makkah to Arafat on the 9th day (Conventional mode) • Allocate up to 35% to be transported via Pedestrian routes
TM2 Makkah to Arafat	SA	2	150	7	<ul style="list-style-type: none"> • Increase number of buses and scheduled time • Allocate up to 60% to be transported from Mina to Arafat on the 9th day (Shuttle mode) • Consider allocating additional groups to pedestrian routes (if fitting) • Allocate up to 10% to be transported by Train
TM3 Arafat to Muzdalifah	Locals	7	900	7	<ul style="list-style-type: none"> • Increase number of buses • Consider allocating additional groups to pedestrian routes (if fitting) • Allocate up to 30% to be transported by Train

The results of this study are generally consistent with the literature; however, there are some differences in the scale of the operations described.

- Al-Sabban and Ramadan (2005) simulated 160,000 TEAA pilgrims travelling on 542 shuttle buses. In this study, all the TEAA groups (245,002 pilgrims) were simulated using various transport modes.
- The simulation results of Al-Sabban and Ramadan (2005) suggested using 500+ buses for the TEAA group during the 8 h Al-Nafrah Movement. This study used more than 800 buses for this movement and successfully transported the TEAA group.

- Jamloom (2017) simulated the Al-Nafrah movement and indicated a total duration of 7.27 h, whereas this study showed that this task is possible in 6 h.
- Yaagoubi (2018) simulated the movements of 66,000 pilgrims using pedestrian routes. This study simulated different percentages of all pilgrim groups using pedestrian routes, all within the validated durations. However, given the weather conditions and the physical strain imposed by Hajj pilgrimage, we considered walking as a fallback solution, showing that public transport (if scheduling is followed) can accommodate more pilgrims.
- Felemban et al. (2019a) simulated 376,000 pilgrims travelling through the train movement C from Arafat to Muzdalifah. This study simulated a larger number of pilgrims (618,000) in a similar scenario, Scenario 3 (TM3).
- Seliaman et al. (2001) simulated 153,000 pilgrims, Koshak and Nour (2013) simulated 58 groups of TEAA, and Felemban et al. (2019a) simulated 120,000+ pilgrims. This study simulated the movements of all Hajj 2019 pilgrims (3 million), which is equivalent to 12,000 groups.

5.8. Conclusion

Hajj involves a large number of pilgrims to be transported between the ritual sites within strict site-time boundaries. The transport process is inherently complex because of the sheer size of the task, short time window to reach at specific sites and several sites with multiple times in and out requirements. The movement of pilgrims also involves massive work plans and coordination between the heterogeneous modes of transport, with complex scheduling, execution and replanning, if needed. Despite meticulous organisation and experience accumulated over the years, Hajj management authorities faces problems in transport management, such as late replanning and cascading effects of any delays.

As Felemban and Rehman (2022) recently pointed out, Hajj transport management and TEs need to work together to distribute the pilgrims by transport modes, with constant (on the ground) observation/monitoring of the transport operations (e.g., tracking vehicles and pilgrims while boarding, alighting, departing, arriving at sites, walking).

Based on the real Hajj 2019 data, we have developed and validated a number of simulation modules for transport and tested several transport scenarios using the DES platform, “ExtendSim”. The work presented here aimed at identifying transport problems during the first two days of Hajj, most intense in pilgrim

movements, and offering potential practical solutions, without increasing the fleets or the crowding of the public transport. The modelling was modular to allow for coupling of the components, as well as focusing on one transport aspect and movement at a time. The first day of transport from Makkah to Mina is included in a single transport module. For the second day, we developed two modules for transport from two origins (Makkah and Mina) to Arafat then from Arafat to Muzdalifah, including all the transport modes available during Hajj. Several transport scenarios were tested with the objective of addressing some of the following problems identified in the literature, such as:

- the increasing numbers of pilgrims at the Hajj;
- the mass movements or transport between the sites within a fixed short window, which can cause congestion and traffic jams on the roads between these sites; and
- scheduling and allocation problems, which if addressed could improve Hajj transport management.

Transport scenarios were developed to foresee possible outcomes of the current transport operations. They relied on using the planned resources and changing the number of pilgrims by their transport mode and time window. In these scenarios, two primary factors were tested: the demand (pilgrim group numbers) and supply (their transport timetables and allocated vehicles), to assess the implications for the services in terms of the adequacy of the fleet to complete the task. Changing the timetables resulted in better results than the scenarios wherein the allocation of pilgrims was changed to the four transport modes. Therefore, we expect that organising group timetables could lead to better transport management outcomes for the Hajj. By applying these measures, the time required for transport can be shortened (by more than 12 h, depending on the scenario) compared to the real-time window currently allowed. Additionally, a dynamic reallocation of the conventional and shuttle bus fleets proportional to the number of pilgrims would reduce the average duration of transport while using the fleets more efficiently. These time reductions are not only representing savings in the Hajj resources, but also lead to better experience of the pilgrims during their Hajj. This is a critical aspect, given the physical effort required during the five days. Considering the heterogeneity of pilgrims (gender, age, cultural diversity) and the presence of pilgrims with some mobility difficulties, any additional resting time created by reducing the transport duration would enhance the quality of the experience for all participants and create buffers to ensure start-on-time for following rituals. However, the scenario results assume that the scheduled activities are followed as planned, avoiding delays and incidents.

Our validated modules and scenarios simulated 2.6 million pilgrims using “ExtendSim”, which represents the typical attendance in Hajj before the COVID-19 led pandemic and a much higher number than some of the published studies. Transport managerial strategies were proposed to overcome some issues in scenarios wherein not all allocated pilgrim groups could be transported within the set time window. Distributing the current bus fleet in a more balanced way and increasing the number of pilgrims using the train would ensure the transport capacity, even when the weather may prevent transport on foot. For future work, additional transport modules for reverse movement from Muzdalifah to Mina and Mina to Makkah can be coupled to an all-encompassing transport module. Similarly, joining the ritual models with the corresponding before-and-after transport modules makes possible a complete integration of the Hajj activities in a single overall model.

Acknowledgment

Almoaid A. Owaidah’s PhD scholarship is funded by the Saudi Arabian Cultural Mission in Canberra, Australia (the educational representative of the Royal Embassy of the Kingdom of Saudi Arabia), and King Abdulaziz University in Jeddah, Saudi Arabia. The authors would like to thank Dr. Bassam Ghulman from the Ministry of Hajj for providing the transport data for this research. The authors would also like to thank Imagine That Inc. for granting access to the “ExtendSim” software for this research.

References

1. Al-Gadhi, S.: Macroscopic Modelling and simulation of Hajj vehicular traffic during Ifadha from Arafa. *Journal of King Abdulaziz University: Engineering Sciences*. 13(2), 305–323 (2001)
2. Al-Sabban, S.A., & Ramadan, H.M.: A simulation study of the shuttle-bus pilgrim transportation system between the Holy sites for the 1422H Hajj Season. *Engineering Sciences*, 16(2), 71–93 (2005)
3. Alshalani, H. J., Alnaghaimshi, N. I., & Eljack, S. M.: ICT System for crowd management: Hajj as a case study. In: *2020 Int. Conf. Comput. Info. Techno. (ICCIT-1441)*, pp. 1–5, IEEE (2020, September)
4. Al-Yagubi, R: Developing a Spatial Data Infrastructure (SDI) for Pilgrims’ Movement and Transportation during Hajj days in Holy Places. In: *15 Scientific Symposium for the Research of Hajj, Umrah and Madina Vist*. Tiba University 27-28 May 2015, pp. 108–116 (2015)
5. Amer, M., & Almatrafi, A.: Using a multi-agent architecture to handle the negotiation between the Hajj authorities and the Hajj travel agents. In: *19th of Hajj, Umrah and Madinah Visit Research - Scientific Bulletin (1440H – 2019)*, pp. 168–174 (2019)
6. Badham, J.: A compendium of modelling techniques. Project 12. Integration Insights, *The Australian National University*, Canberra, Australia. (2010)
7. Bianchi, R.R.: Reimagining the Hajj. *Social Sciences*, 6(2), pp. 1-26 (2017)
8. Currie, G., & Shalaby, A.: Synthesis of transport planning approaches for the world's largest events. *Transport Reviews*, 32(1), pp.113-136 (2012)
9. Department of Transport at Ministry of Hajj: *Hajj works report 2019* (1440 H). <https://cloudstor.aarnet.edu.au/plus/s/R3m6WvUK57F597W> (2019). Accessed on 02/01/2020.

10. Dridi, M.H.: List parameters influencing the pedestrian movement and pedestrian database. *International Journal of Social Science Studies*, 3, pp. 94-106 (2015)
11. Dtalessandro, K., Abd, W., & Al Mubarek, H.: World's largest gathering: Muslim mass pilgrimage poses EMS logistical & planning challenges. *Journal of Emergency Medical Services (JEMS)*. 38(9), pp. 52–57 (2013)
12. Edrees, M.: Suggestions and Solutions for Crowded Sites in the Holy Environs “Arafat Area.” *King Abdulaziz University Journal: Environmental Design Sciences*. 11(1), 137–173 (2017)
https://www.kau.edu.sa/AccessPage.aspx?Site_ID=320&lng=EN&SYS_ID=203
13. Extendsim User Reference. <https://extendsim.com/flipbooks/ExtendSimUserReference.pdf>. Accessed 18 March 2020
14. Felemban, E., Fatani, A., & Rehman, F.U.: An Optimized Scheduling Process for a Large Crowd to Perform Spatio-temporal Movements Safely during Pilgrimage. In: *2019 IEEE International Conference on Big Data (Big Data)*, pp. 6049–6051, IEEE (2019a)
15. Felemban, E., Rehman, F. U., Biabani, A. A., Naseer, A., & AlAbdulwahab, U.: Towards Building an Interactive Platform for Analyzing Movement of Buses in Hajj. In: *2019 IEEE International Conference on Big Data (Big Data)*, pp. 3775–3778, IEEE (2019b)
16. Felemban, E., Rehman, F.U., Biabani, S.A.A., Ahmad, A., Naseer, A., Majid, A. Hussain, O., Qamar, A., Felemban, R., & Zanjir, F.: Digital Revolution for Hajj Crowd Management: A Technology Survey. *IEEE Access*. 8, pp. 208583-208609 (2020)
17. Felemban, E., Ur Rehman, F.: An Interactive Analysis Platform for Bus Movement: A Case Study of One of the World’s Largest Annual Gathering. In: *Rodrigues, J.J.P.C., Agarwal, P., Khanna, K. (eds) IoT for Sustainable Smart Cities and Society. Internet of Things*. Springer, Cham. https://doi.org/10.1007/978-3-030-89554-9_6 (2022).
18. Fourati, J., Issaoui, B., & Zidi, K.: Literature Review of Crowd Management: A Hajj Case Study. In *ICINCO* (1), pp. 346–351 (2017)
19. Geabel, A., Jastaniah, K., Hassan, R.A., Aljehani, R., Babadr, M., & Abulkhair, M.: Pilgrim Smart Identification Using RFID Technology (PSI). In: *International Conference of Design, User Experience, and Usability*, pp. 273–280, Springer, Cham (2014).
20. Gleye, F., Reggelin, T., & Lang, S.: Comparison of a microscopic discrete-event and a mesoscopic discrete-rate simulation model for planning a production line. In: Affenzeller, Bruzzone, Jiménez, Longo and Piera (Eds) *Proceedings of the European Modeling and Simulation Symposium, 2017*. (2017)
21. Hajj Traffic. www.Hajjtraffic.com Accessed on 10 May 2022.
22. Hanjra, A., & Sherry.: Simulation Environments. *International Journal of Engineering Research and General Science*. 4(3), pp. 589–594 (2016). <http://pnrsolution.org/Datacenter/Vol4/Issue3/84.pdf>
23. Hanrahan, M.: Managing Mecca: planning a transport system for Hajj. In: *Australian Institute of Traffic Planning and Management (AITPM) National Conference, 2015*. Brisbane, Queensland, Australia (2015)
24. Jamil, S., Basalamah, A., Lbath, A., & Youssef, M.: Hybrid participatory sensing for analyzing group dynamics in the largest annual religious gathering. In: *Proceedings of the 2015 ACM International Joint Conference on Pervasive and Ubiquitous Computing*. pp. 547–558 (2015, September).
25. Jamjoom, A.: Implementation of a Simulation Model for Optimizing the Traffic Flow from Arafat to Muzdalifah. *European Scientific Journal*, 13(33), pp. 390–402 (2017).
26. Kassens-Noor, E.: Planning for Peak Demands in Transport Systems—An Agenda for Research. In: *Selected Proceedings of the 12th World Conference on Transport Research. Lisbon: World Conference on Transport Research Society*, pp. 1–19 (2010).
27. Kassens-Noor, E.: Managing Transport during the Olympic Games. In: Frawley, S., & Adair, D. (Eds.). *Managing the Olympics*, pp. 127–146. Palgrave Macmillan, London (2013).
28. Kassens-Noor, E.: Olympic Transport. In: Gold, J. R., & Gold, M. M. (Eds.) *Olympic cities: City agendas, planning, and the world's games, 1896–2020*, pp. 253–265. Routledge (2016a).
29. Kassens-Noor, E.: From ephemeral planning to permanent urbanism: An urban planning theory of mega-events. *Urban Planning*, 1(1), pp. 41–54 (2016b).
30. Kassens-Noor, E., & Fukushige, T.: Olympic Technologies: Tokyo 2020 and Beyond: The Urban Technology Metropolis. *Journal of Urban Technology*, 25(3), pp. 83–104 (2018).
31. Kaysi, I., Alshalalfah, B., Shalaby, A., Sayegh, A., Sayour, M., & Gutub, A.: Users’ Evaluation of Rail Systems in Mass Events: Case Study in Mecca, Saudi Arabia. *Transportation Research Record*, 2350(1), pp. 111–118 (2013).
32. Kaysi, I., Sayour, M., Alshalalfah, B., & Gutub, A.: Rapid transit service in the unique context of Holy Makkah: assessing the first year of operation during the 2010 pilgrimage season. *Urban Transept XVIII*. 18, pp. 253-267 (2012).
33. Koshak, N.: Developing a web-based GIS for hajj traffic plan (HajjGIS. Net). *Journal of Urban Planning Research, Cairo University*, 6(6), pp. 1–13 (2006).
34. Koshak, N., Nour, A., & Center, K.G.I.: Integrating RFID and GIS to support urban transportation management and planning of Hajj. In: *The 13th International Conference on Computers in Urban Planning and Urban Management. July 2–5, 2013, Utrecht, The Netherlands*, pp. 1-20 (2013).
35. Krahl, D.: ExtendSim technology: scenario management. In *Proceedings of the 2011 Winter Simulation Conference (WSC)*. pp. 12-19, IEEE (2011, December)

36. Krahl, D.: ExtendSim: a history of innovation. In: *Proceedings of the Winter Simulation Conference*. pp. 1–8 (2012).
37. Laguna, M., & Marklund, J.: Business process modelling, simulation and design. *CRC Press*. (2013).
38. Makkah Region Development Authority. https://www.mrda.gov.sa/video_gallery.php. Accessed 5 August 2019.
39. Miralam, M., & Jaziri, R.: Application of Failure Mode Effect and Critical Analysis (FMECA) to the Transportation System “Daiif” in Holy Places. In: *19th Scientific Forum of Hajj, Umrah and Madinah Visit Research - Scientific Bulletin (1440H – 2019)*, pp. 209–219 (2019).
40. Mohsen, I., & Shihatah. Sustainable Transport Systems for Hajj. *Journal of Al-Azhar University Engineering Sector (JAUES)*. 8(26), pp. 1-14 (2012).
41. Owaidah, A., Oлару, D., Bennamoun, M., Sohel, F., & Khan, N.: Review of modelling and simulating crowds at mass gathering events: Hajj as a case study. *Journal of Artificial Societies and Social Simulation*, 22(2), 1–9 (2019).
42. Owaidah, A. A., Oлару, D., Bennamoun, M., Sohel, F., & Khan, R. N. Modelling Mass Crowd Using Discrete Event Simulation: A Case Study of Integrated Tawaf and Sayee Rituals During Hajj. *IEEE Access*, 9, 79424-79448. (2021).
43. Quan, K., King, G., & Schrimpf, T.: Discrete event simulation—a tool to support the design of complex production and logistic processes; its application in underground mine design. In: *Proceedings of the International Seminar on Design Methods in Underground Mining*. pp. 443–462, Australian Centre for Geomechanics (2015).
44. Seliaman, M.E., Duffuaa, S., & Andijani, A.: A Stochastic Simulation Model for the Design of a Shuttle Bus System to Transport Pilgrims in Hajj. *Researchgate, Berlin*, pp. 1-19 (2001).
45. Serova, E.: The role of agent-based modelling in the design of management decision processes. *Electronic Journal of Information Systems Evaluation*, 16(1), pp. 71–80 (2013).
46. Sharma, P.: Discrete-event simulation. *International Journal of Scientific & Technology Research*, 4(4), pp. 136–140 (2015).
47. Shlaby, A., Isam, K., Al-Zahrani, A., Alshalalfah, B. & Sayegh, A.: Towards a sustainable transportation system for the Holy City of Makkah: Coping with harsh topography, dense urban area and large-scale religious events. In: *17th International Road Federation (IRF) World Meeting and Exhibition 2013*. pp. 1–15 (2013).
48. Tayan, O.: A proposed model for optimizing the flow of pilgrims between Holy sites during Hajj using traffic congestion control. *Proceedings of International Journal of Engineering and Technology*, 10(2), 55–59 (2010).
49. Tayan, O., & Al-Binali, A.: Evaluation of a proposed intelligent transportation framework using computer network concepts: A case study for Hajj-pilgrim traffic monitoring and control. *International Journal of Computer Science Issues (IJCSI)*, 10(2 Part 2), pp. 325-330 (2013).
50. Tayan, O., Al BinAli, A.M., & Kabir, M.N.: Analytical and computer modelling of transportation systems for traffic bottleneck resolution: A Hajj case study. *Arabian Journal for Science and Engineering*. 39(10), pp. 7013–7037 (2014).
51. World Health Organization: *Public Health for Mass Gatherings: Key Considerations* (1st ed.). World Health Organization (2015).
52. Yaagoubi, R., Miky, Y. & Hajji, H.: Toward a combined GIS-ABM approach for simulation of pilgrims’ movement during Hajj days in Mekkah. *International Conference on Modern Intelligent Systems Concepts*. Rabat, Morocco (2018).

Appendix – Tables

Table 5-12: Pilgrim speeds at Hajj event (Dridi 2015)





Speed/Velocity (m/s)	Category	Fitness	Age (years)
1.46	Africa and Asia	Fit	10-50
1.2095			50+
1.3115		Tired	10-50
1.0885			50+
1.1658		Very tired	10-50
0.9676			50+
1.3247	North America, South America, and Europe	Fit	10-50
1.0995			50+
1.1923		Tired	10-50
0.9896			50+
1.0598		Very tired	10-50
0.8796			50+

Table 5-13: Conventional Bus Operations from Makkah to Mina on the 8th

Bus station	Near to gate of the Grand Mosque	Distance from the bus station to gate (by walking)	Main road/street from the bus stations of The Grand Mosque to Mina	Distances from bus stations of the Grand Mosque to pilgrims' groups' camps at Mina	Pilgrim groups using bus station
Ajjad road	King Abdulaziz Gate	1 km/ 13 min	King Fahad road/tunnel Rd. 68	10 km/18 min	South Asia
			King Khaled road/tunnel	11.6 km/28 min	Locals
			3 rd ring road and Muzdalifah road	13 km/38 min	
Ibraheem Al-Khalil Road	King Fahad Gate	800 m/12 min	Rd. 68	11.2 km/ 35 min	Arab
			Rd. 38	15.3 km/ 39 min	
Ibraheem Al-Kalil Road 2 (beside Al-Shabekah Graveyard)	Umrah Gate	300 m/ 6 min	Rd. 68	12.6 km/ 32 min	South-East Asia
			Route 40-route 80- 4 th ring road	17.6 km/29 min	
SAPTCO – Northwest The Grand Mosque	King Abdullah Gate	920 m/ 14 min	Rd. 68	9.8 km/ 22 min	Africa
			Route 40-route 80- 4 th ring road	10.7 km/ 35 min	
SAPTCO – Northeast the Grand Mosque	Al-Fatah Gate	1.1 km/ 14 min	Rd. 68	9.6 km/ 20 min	TEAA
			Route 40-route 80- 4 th ring road	14.1 km/ 25 min	
			Al-Majid Al-Haram Road and Rd. 68	13.9 km/ 38 min	
			Route 15	18.2 km/ 36 min	
Mina Transit station	Al-Marwah area Gate	256 m/ 4 min	Rd. 68	9.7 km/ 18 min	Iranian
			Al-Majid Al-Haram Road and Rd. 68	10.5 km/ 30 min	

Note: Buses routes are available on Google Map

Table 5-14: Extendsim Blocks Used in the Models (Extendsim User Reference, 2020) [Laguna & Marklund, 2013] *

Block	Function	Block shape/icon
Transport Block	Used to transport items from one point to another depending on distance and speed.	
Batch/Unbatch Blocks	Used to combine specified number of inputs into a single output and unbatch a single input to a chosen number of outputs.	
Resource Pool Block	Used to hold a specified number of capacity units (e.g., buses and trains) for items (pilgrims) passing through the block.	
Shift Block	Generates schedule over time to be used in the model.	

* Note: Other blocks descriptions are available in Table 3-13 Chapter 3 and Table 4-1 Chapter 4.

Table 5-15: Planned bus durations vs Actual bus durations from Hajj 2019

Group	Movement	From (Date and time)	To (Date and time)	Transport durations (Hours)	Difference (Actual-Planned) (Hours)
SEA	Makkah-Mina (Planned)	7/08/2019 18:00	8/08/2019 2:00	8	+1
	Makkah-Mina (Actual)	7/08/2019 18:00	8/08/2019 3:00	9	
	Makkah-Arafat (Planned)	8/08/2019 12:00	9/08/2019 3:00	15	+14
	Makkah-Arafat (Actual)	8/08/2019 5:00	9/08/2019 10:00	29	
	Mina-Arafat (Planned)	9/08/2019 6:00	9/08/2019 10:00	4	+1
	Mina-Arafat (Actual)	9/08/2019 5:00	9/08/2019 10:00	5	
Iran	Makkah-Mina (Planned)	8/08/2019 18:00	9/08/2019 0:00	6	-2
	Makkah-Mina (Actual)	8/08/2019 18:00	8/08/2019 22:00	4	
	Makkah-Arafat (Planned)	8/08/2019 17:00	9/08/2019 1:00	8	+1
	Makkah-Arafat (Actual)	8/08/2019 17:00	9/08/2019 2:00	9	
	Mina-Arafat (Planned)	9/08/2019 6:00	9/08/2019 11:00	5	-1
	Mina-Arafat (Actual)	9/08/2019 6:00	9/08/2019 10:00	4	
Africa	Makkah-Mina (Planned)	8/08/2019 1:00	8/08/2019 11:00	10	+5
	Makkah-Mina (Actual)	7/08/2019 19:00	8/08/2019 10:00	15	
	Mina-Arafat (Planned)	9/08/2019 7:00	9/08/2019 10:00	3	+7
	Mina-Arafat (Actual)	8/08/2019 22:00	9/08/2019 8:00	10	
SA	Makkah-Mina (Actual)	8/08/2019 6:00	8/08/2019 11:00	5	N/A
	Makkah-Arafat (Actual)	9/08/2019 7:00	9/08/2019 9:00	2	
	Mina-Arafat (Actual)	9/08/2019 1:00	9/08/2019 11:00	10	
Arabs	Makkah-Mina (Actual)	7/08/2019 16:00	8/08/2019 11:00	30	N/A
	Makkah-Arafat (Actual)	8/08/2019 18:00	8/08/2019 9:00	15	
	Mina-Arafat (Actual)	8/08/2019 21:00	9/08/2019 8:00	11	
Locals	Makkah-Mina (Actual)	8/08/2019 12:00	9/08/2019 00:00	12	N/A
	Mina-Arafat (Actual)	8/08/2019 9:00	8/08/2019 20:00	11	

Note: Data on planned timetables for TEs Locals, SA, Arabs were not provided, therefore table provides only the actual times.

Appendix – Figures

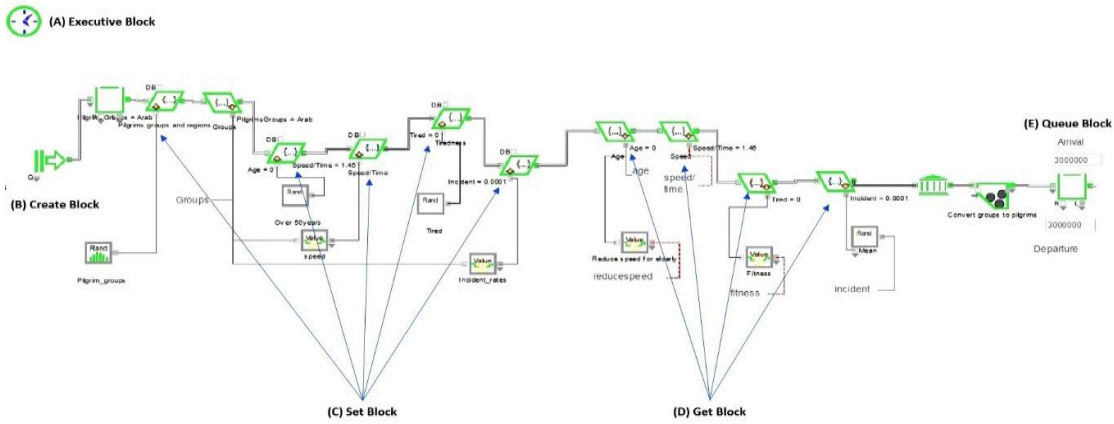

Figure 5-6: Transport Module (TM) 1 represents the movement of pilgrims from Makkah to Mina on the 8th of Zil Hijjah

(A) Executive, (B) Create, (C) Set, (D) Get, and (E) Queue blocks

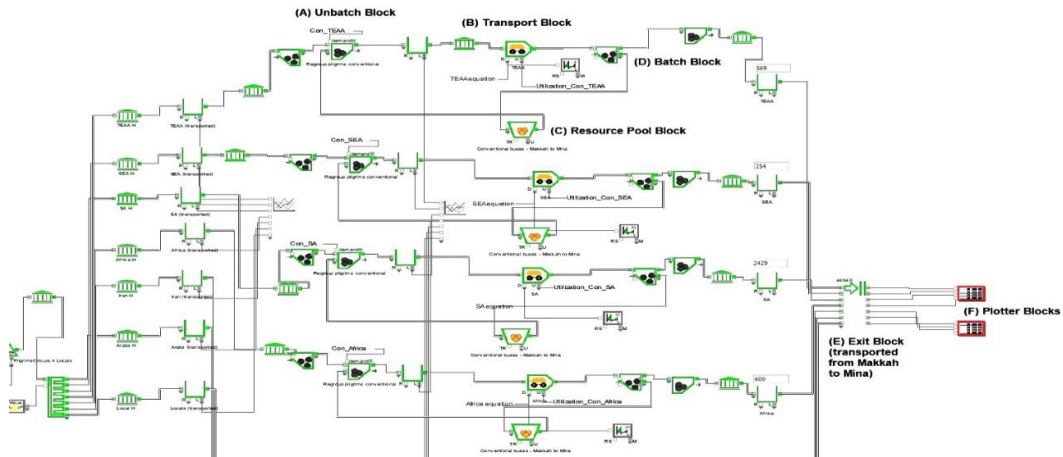

Figure 5-7: TM1 (A) Unbatch, (B) Transport, (C) Resource, (D) Batch (E) Exit, and (F) Plotter blocks

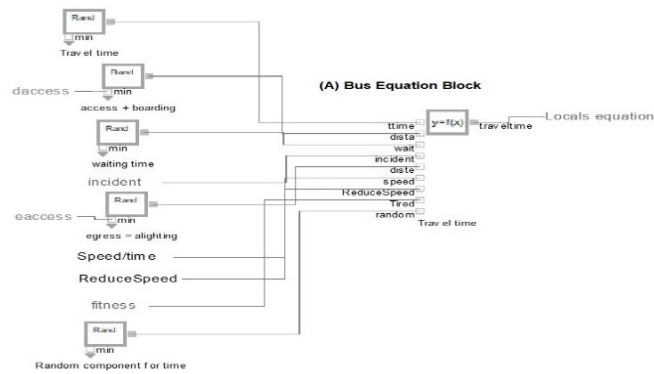

Figure 5-8: TM1 Example Equations Block

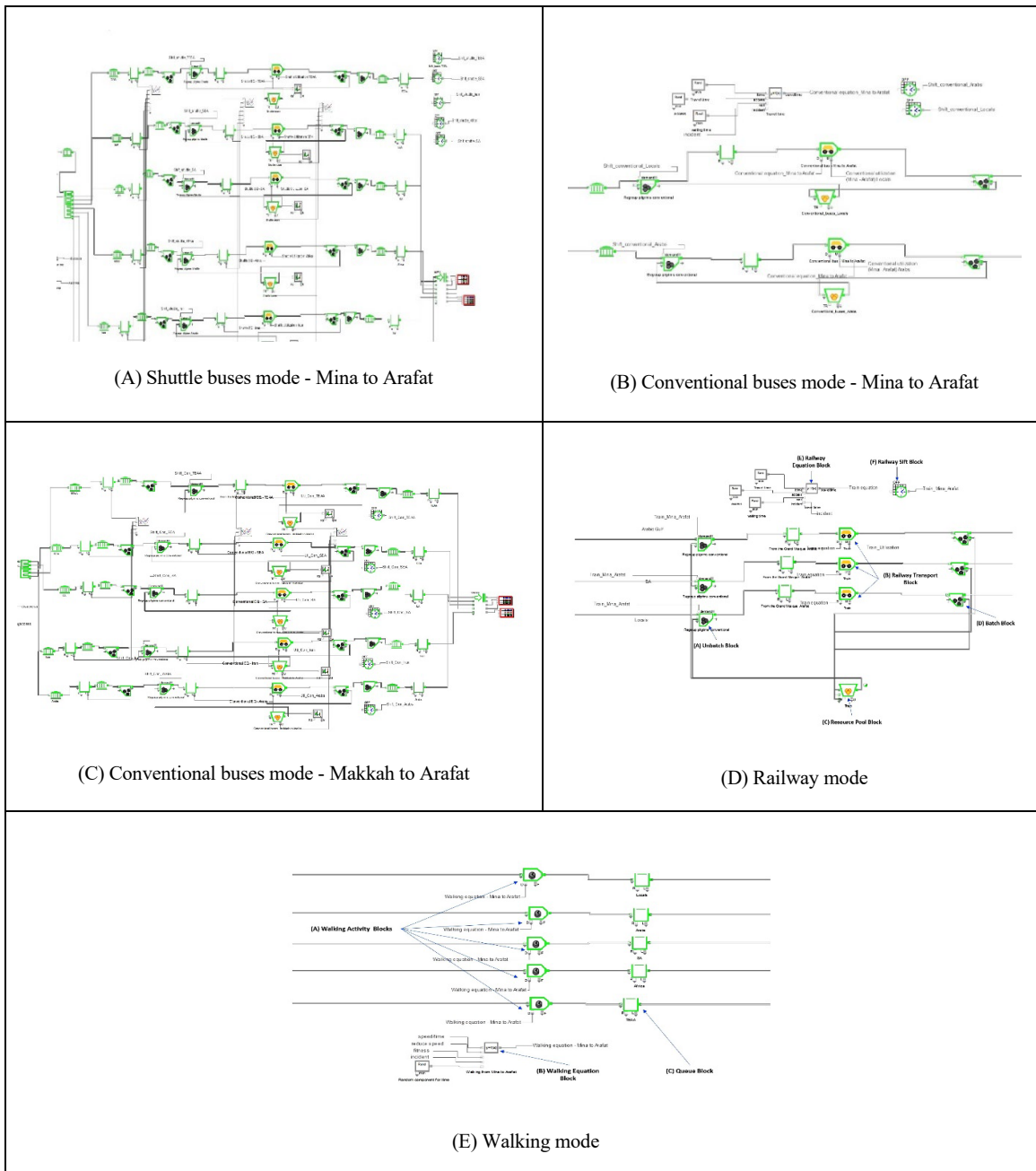

Figure 5-9: Transport Module (TM) 2 represents the movement of pilgrims from Makkah to Arafat (Conventional buses) (C) and Mina to Arafat by, Shuttle buses (A), Conventional buses (B), trains/railways (D) and Pedestrian routes (E).

Note: Models are made available at: <https://cloudstor.aarnet.edu.au/plus/s/aY2LeV4wrDYYc1V>

Chapter 6

Chapter 6 : Conclusion

6.1. Thesis Summary

Using scenario analysis, this thesis models/simulates rituals and transport during the Hajj event, which is the largest annual pilgrimage in the world. Hajj is a challenging case for crowd management, considering its size (millions of pilgrims from all over the world attend the Hajj, representing many different cultures and languages) and features (sequences of activities within specific areas for a limited amount of time - 5 days). As there have been many serious crowd incidents at the sites in the past, there is still a need for practical solutions for managing the Hajj.

In this thesis, crowd simulation models were developed in normal and emergency situations, testing how different strategies (changing pilgrim allocations during rituals to meet the supply of services and infrastructure, scheduling pilgrim movement between sites and rituals, and changing order of arrivals) affected throughput, duration, and levels of utilisation. The remainder of this chapter describes the structure of the thesis, its contribution, and its practical implications, and concludes with suggestions on further research.

In Chapter 2, I presented a systematic literature review of Hajj as an MG event and the historical development of crowd simulation and modeling related to Hajj rituals. The results of such research are critical to developing new plans and strategies for mitigating crowd incidents that may cause injuries and fatalities. The chapter presented 75 studies on crowd modelling and simulation for normal and emergency situations, along with new crowd management strategies. Specifically, I concluded that the pilgrim movements in Tawaf, Sayee, and Aljamarat areas require more attention as pilgrim numbers increase. The previous Hajj studies and their crowd modeling and simulations focused on Tawaf and Sayee rituals at the Grand Mosque and crowds at Aljamarat Bridge separately. My evaluation assessed the potential applications of these studies and their simulators, as well as their impact on the planning and operation of Hajj events. Research gaps (primarily the fragmented approach to the Hajj and the analysis of 'bottlenecks') were identified and used to inform the modelling decisions for the following chapters.

In Chapter 3, I modelled and simulated the two rituals of Tawaf and Sayee, performed in sequence at the Great Mosque. Models and simulations were conducted using a DES, ExtendSim, for both normal and evacuation scenarios and validated with 2019 data. Unlike previous studies that modelled these two rituals

as separate events, my study integrated them to understand their relationship, as well as their joint impact on pilgrim organisation in the GM. I developed more than 200 scenarios to identify crowding and congestion within the GM areas. These scenarios evaluated the effects of changes in pilgrim distributions at GM and explored different ways of managing the pilgrims entering and exiting the GM. The results showed that distributing pilgrim groups according to the capacity of each level of the GM achieved the best quality of service (LoS), with all pilgrims completing the rituals within 30 hours. As an example, allocating over 30% of pilgrims at the upper levels of Tawaf and Sayee would cause queues and decrease the LoS (or increase density to more than 4 pilgrims/m²). The results also identified the reserve capacity and the percentage of pilgrims (between 30% to 80%) who can be accommodated in the Tawaf area (Mataf) and GL for Sayee. With higher percentages of pilgrims at other Tawaf and Sayee levels, the scenarios showed delays and limited capacity to help all pilgrim groups complete the rituals within the allotted time frame. I have also developed evacuation scenarios for emergencies to identify areas and pathways for quick response. Compared with earlier studies, evacuation results under various scenarios showed better results regarding evacuation durations, by using shortest paths, and informing and training guides and pilgrims of the evacuation routines.

In Chapter 4, I evaluated the safety and efficiency of performing the 'Stoning the Devil' ritual on the Aljamarat Bridge. The current crowd management on the bridge includes developing timetables, designing specific routes and levels for pilgrim groups, and setting unidirectional movements. It is still possible that crowd incidents will occur, especially during emergency evacuations from the bridge. In this chapter, the rituals on the bridge were modelled and simulated using the same ExtendSim software. The models were also validated using the data for Hajj 2019. Furthermore, evacuation scenarios from the six towers were developed and tested, using discrete evacuation times subjectively chosen two hours apart. These evacuation scenarios are based on both scheduled and stochastic arrivals at the bridge, taking into account the possibility of exiting at the nearest tower. The average evacuation duration for the scheduled arrivals scenarios varied between 9.97 minutes to 10.48 minutes for the six towers. The evacuation was conducted smoothly without any crowd building and allowing for a total number of pilgrims on the bridge above 300,000 as per the scheduled arrivals. For random arrivals, the average evacuation duration from all towers was higher, ranging between 11.20 to 15.35 mins. The evacuation times were similar to the exit times in normal conditions, since the bridge is large enough to accommodate millions of pilgrims performing the

ritual within 24 hours. As expected, closing towers would increase the evacuation times by 1.5-2.1 mins for scheduled arrivals and with 3-4.4 min for random arrivals. The results confirm the importance of scheduling to control crowd levels on the bridge during the evacuations. In comparison with an earlier study, the findings of this research showed a shorter evacuation time and more pilgrims evacuated.

Chapter 5 discussed pilgrim movements between the holy sites of Mina, Muzdalifah, and Arafat using Hajj transport modes. The current modes of Hajj transport consist of: conventional buses (performing 1-2 round trips/day), shuttle buses (performing 3 to 9 round trips/day), train services, and pedestrian routes connecting the holy sites. However, increased pilgrim numbers, changes in bus schedules and timetables, as well as poor coordination between transport modes have caused congestion and delays in transporting pilgrims between sites, which has affected Hajj rituals in a cascading manner. Three transport modules that represented the movements from Makkah to Mina on the 8th, Makkah and Mina to Arafat on the 9th and Arafat to Muzdalifah on the 9th, were developed and validated based on the collected data of Hajj 2019. The scenarios focused on changing the allocated percentages of the pilgrim groups and reorganising the transport, by aligning schedules and compressing the time window from 48 hours to 36, 32, and 24 hours. The models and scenarios simulated 2.6 million pilgrims using all transport modes, which is more than previous works. The scenarios indicate what percentage allocations each TE should receive for each route and transport mode to reach an acceptable LoS. I suggested alternative modes of transport for TEs that had disproportionately high bus utilisation and aimed to allocate buses proportionally to the TE sizes. Moreover, scenarios exploring the split between transport modes have shown that pilgrims can be transported between sites using current fleets, while walking is reduced. Regarding the “compressed window scenarios” (36-, 32- and 24-hours), reorganising the transport timetables produced superior results than the scenarios where allocations by transport mode were considered. This suggests that changing the timetables for these groups could lead to better transport management outcomes, with shorter transport times (12, 16 and 24 hours) than what was observed in 2019. The bus rearrangements included: staggered/sequential departures; scheduling the transport task in two time periods, by combining large and small TEs, resulting in a more even utilisation of the vehicles; and simultaneous start (all groups start moving at the same time).

The results show that rearranging the order in which the TEs are transported between sites is likely to improve/shorten pilgrim travel times, thus it represents a successful method of managing pilgrim transport.

This study suggested potential solutions and transport management strategies to manage Hajj transport and its fleets, which included appropriate resource allocations and optimal timetables in the planning process for the event of Hajj.

6.2. Contributions of the Thesis

This thesis examines new approaches to crowd management during Hajj, emphasising the importance of planning/organising the processions at various holy sites in order to prevent overcrowding and incidents. Several simulation models were developed to mimic the Hajj rituals and activities, and to study various scenarios of operation and evacuation during the Hajj. The models, developed using a DES platform, can be integrated into a 'laboratory of experimentation' or a decision support system for practical use. The ExtendSim models presented in each chapter have similar structure and use similar block types, making it easier for users to apply and test the models in different new scenarios. As the level of analysis is meso, the DES allows for modelling Hajj at a 'real scale'; in particular, millions of pilgrims performing the main Hajj rituals (Tawaf, Sayee, Stoning the Devil) at the most constrained sites (the Grand Mosque and Aljamarat Bridge) were modelled, and their transport between the Hajj holy sites.

Without modelling every pilgrim, the models allow for detailed descriptions of activities, taking into account the heterogeneity of behaviours through the attributes of the pilgrims in every TE. In the simulation models developed in this research, geo-accurate representations of space were used to assess the impact of changing operations and to address evacuation problems. The meso level of modelling is a key feature, allowing for realism and accurate representation of the behaviour of large groups of pilgrims, while simplifying individual elements that are unlikely to be typical for Hajj. Future research designs may benefit from this methodological aspect in understanding MG events.

Simulations were conducted under multiple scenarios to evaluate the effectiveness of the current measures and to determine the impact of alternative measures: when crowding or congestion could occur (e.g., GM, Aljamarat Bridge or during transport between sites), changes in arrival schedules and routes, optimised timetables, redistribution of the TE groups and information systems are critical so that the groups can safely and efficiently move between locations and activities.

Based on the models presented in this thesis, a decision support system (DSS) can be created to assist professionals to improve Hajj preparations, but also to mitigate the impacts of incidents by establishing

buffers and reserves of capacity. It is easy to couple these modules, following the sequence of events at each holy site and the procedure for transporting pilgrims between them during Hajj. Hajj planners will benefit from this seamless integration as they can now see other possible events and solutions, provided that the model is installed on a computer that can deliver results much faster.

From a managerial perspective, the validated model revealed several mismatches between the level of demand and infrastructure (use of various levels of the GM or the bridge), vehicles (allocation of buses and trains) and processes used during Hajj (e.g., timing/timetabling of various TE groups). Researchers and authorities can use the model to anticipate outcomes and to proactively manage infrastructure and services and provide solutions that can enhance the Hajj, making it a straightforward, more efficient solution that might increase safety. As a result of these improvements, Hajj costs will decline and the experience of Hajj pilgrims will improve as well.

6.3. Translation into Practice

In this thesis, I presented enhancements to Hajj crowd management based on the suitably allocated percentages for each TE entering and exiting from a specific gate, entrance point, or level of the GM or Aljamarat Bridge, as well as transported between sites by multiple modes of travel.

At the GM, the LoS and their equivalent pilgrims' percentages at the Tawaf and Sayee levels were determined to organise and distribute pilgrims appropriately. Crowded areas/levels at the Mosque were identified at which delays could increase. The proposed crowd management methods are applicable for large numbers of pilgrims up to 4 million. It is recommended that the pilgrims be distributed starting from the Tawaf and Sayee critical areas (Tawaf area and Sayee GL), and then moving on to the other levels. Closing entry and exit gates as well as some Tawaf and Sayee levels is not recommended as it will negatively affect the LoS.

During the prior planning stage, it would be beneficial to organise the pilgrims' movements in order to avoid various pilgrim groups crossing each other, causing delays, and to arrange better arrival and departure schedules at the Grand Mosque. As an example, pilgrims who are well and fit and can finish the rituals quickly can be scheduled to arrive earlier, at the beginning of the Tawaf Al-ifadah day. Pilgrims who are less fit and require more time for their ritual performance can be scheduled to arrive later.

For the evacuation procedures from GM, pilgrims' groups can be evacuated from the nearest exit gates

by using all the GM gates. The evacuation routes, training, scheduling, and assessing the pilgrims' physical condition are all critical components of a faster evacuation. Ideally, evacuation training should be offered before arrival or at least to the group leaders who are familiar with the GM site and have performed Hajj rituals before.

With regard to the Aljamarat Bridge, distributing the pilgrims evenly on the bridge showed efficient crowd flow and management. In the event of an emergency and evacuation, all six towers should be used to direct pilgrims to the nearest exit. From the results of the evacuation, we found there was no crowding as the bridge had sufficient capacity to accommodate vast numbers of pilgrims. In contrast, closing one or/and two towers during the evacuation may lead to substantial delays. The scenarios assumed that pilgrims receive prompt and effective instructions to move to the nearest tower to exit the bridge, therefore, scheduling and evacuation training are significant in Hajj planning to increase adherence to instructions and eliminate preventable incidents.

Finally, depending on the mode of transport, using appropriate percentages of allocation of the TE by transport modes and reorganising the time windows would reduce travel durations and allow pilgrims to rest more at their destination. The rearrangement of bus schedules is an effective means of transport management to avoid congestion and traffic jams while transporting groups. These measures could enable transport to occur in less time, creating buffers that would absorb any delays in the proceedings, rather than propagating them to subsequent rituals. By reducing the number of pilgrims walking, temperature-related illnesses and incidents would decrease and the quality of the pilgrimage would improve. Scheduling changes have the potential to reduce the overall travel time door-to-door, resulting in a win-win for pilgrims, operators, and authorities.-

All results of the modelling and simulation of pilgrim activities and transport movements during Hajj lead to recommendations for unified plans to manage crowds and transport during Hajj. All stakeholders can collaboratively use these plans as the basis for a DSS for Hajj that can be used for preparation, mitigation, and recovery.

6.4. Limitations and Lessons Learned

The meso-macro approach utilised in this thesis when modeling the pilgrim groups and testing scenarios

means that the pilgrim groups were considered fairly homogeneous, with little interpersonal interaction at the micro level. In addition, DES models do not provide the same level of granularity as typical traffic models. In section 3.8 (chapter 3), we propose combining the DSS with other micro-level components as a future direction. In addition to the fact that no data was available for validation, the simulations have not explicitly included emergency services movements. Hajj reports indicate that dedicated lanes and relevant personnel are on the ground at the time of the Hajj.

Collecting the Hajj data was time-consuming as it was collected from various locations and multiple sources. Many models and their scenarios were developed for each Hajj ritual, activity, evacuation, and transport during the development of the modelling phase. The development of these scenarios, extracting and analysing their results, took a significant amount of time. As a result of the rapid onset of COVID-19, further interactions for feedback and consultation with local authorities were not possible.

6.5. Future Work

Ideally, future work would focus on integrating the models and testing the organisation of the entire Hajj. Future research could focus on the development/refinement of modules for other activities and their inclusion into an overall hybrid (meso-micro) model. By combining physics-based microsimulation of pedestrian movements and road traffic, the proposed hybrid system could provide insight into decisions at multiple levels: strategic, tactical, and operational. This is particularly important in a post-pandemic era when preventing infections and spreading diseases will remain a major concern.

While the current model aims to proactively improve the performance of the Hajj proceedings, new objective functions should be considered to maximise the quality of pilgrim experience (minimise delays, extend rest times). Given the continuous improvements in infrastructure (e.g., new buildings in Mina, expanding road capacity, changing depot locations), the current model could be used for testing long-lasting effects. On the other hand, Machine Learning would be beneficial to be considered in Hajj crowd and transport management.